

# GAMA SONIC<sup>®</sup>

## SOLAR LIGHTING



10051



10003



10001

# SOLAR COACH LANTERN

Part #: 10001, 10003, 10051

 Please read the instruction manual carefully to obtain the best results from your purchase.

**Thank you for your purchase.** GAMA SONIC® solar charged lights are brighter and last all night with a full day solar charge. Unique designs, superior light output, and numerous installation options confirm the outstanding value of our product.

For technical assistance and more information call our Toll-Free number:

**800-835-4113** (only within the US)

Or

visit our website or download the latest version of your instruction manual:

**www.gamasonic.com** Or **www.gamasonic.com/user-guides**

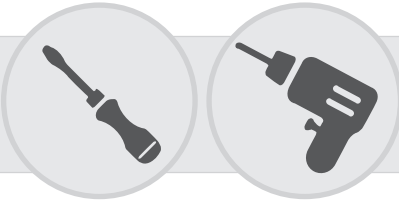

Tools that are needed but not supplied with the solar post lamps are: a screwdriver, power drill.

## Solar Lamp Location:

For optimum light duration throughout the night, it is very important to place your solar lamp in a spot where it will receive the maximum amount of direct sunlight throughout the day.

**Note:** The unit will operate optimally after 2 full days of charging in direct sun in the "LOW" or "HIGH" position.

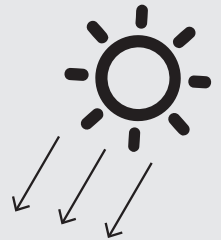

## What's Inside:

Open your package and remove the contents. Check to make sure all pieces are present and accounted for.

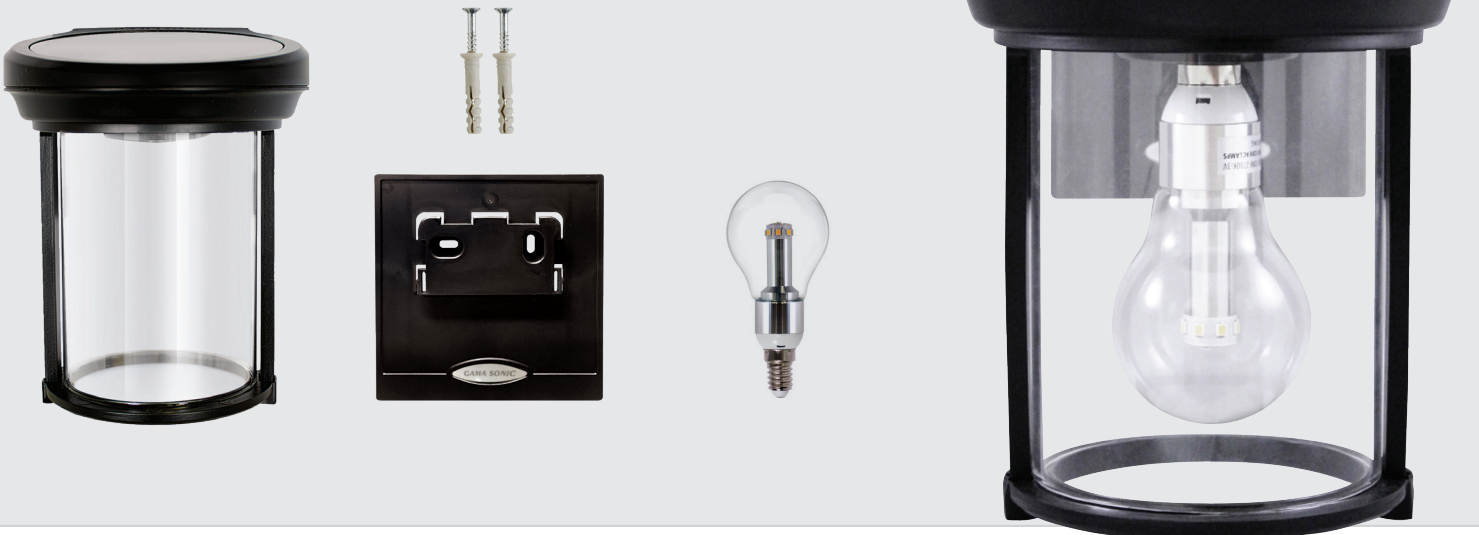

## Operation Instructions

1. Remove part (A) from part (B) by screwing in Fig. 1.
2. Screw in provided A50WW10W Gama Sonic bulb while gripping the base only (Fig. 2).

WARNING: GAMA SONIC® Light bulbs are not to be used in other electrical sockets these are low-voltage light bulbs that are built and designed for our products only.

3. Reattach part (A) to part (B). Turn the operation switch (Fig. 3) to the LOW or HIGH position, and the solar lamp will automatically operate from dusk to dawn.

Fig.1

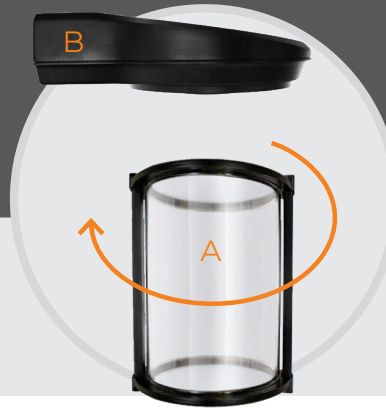
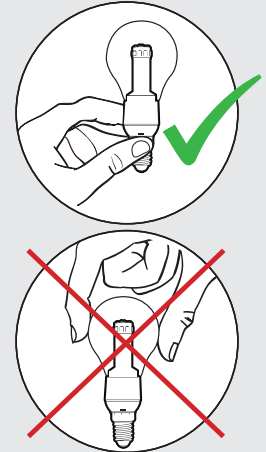
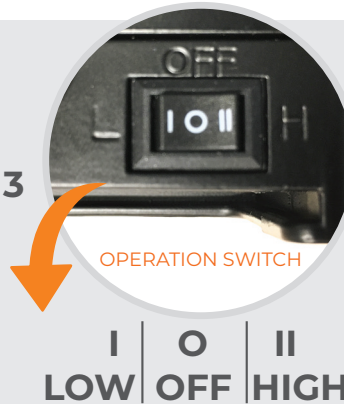

Fig. 2



Fig.3



## Installation Instructions

1. Screw the wall mount (B) to a flat, vertical surface by drilling two holes and inserting the wall anchors. Then align the wall anchors with the holes on the wall mount plate and twist the screws in to hold in place. (Fig. 4).
2. Simply slide the fixture (A) down onto the grooves on the wall mount (Fig. 5).

Fig.4

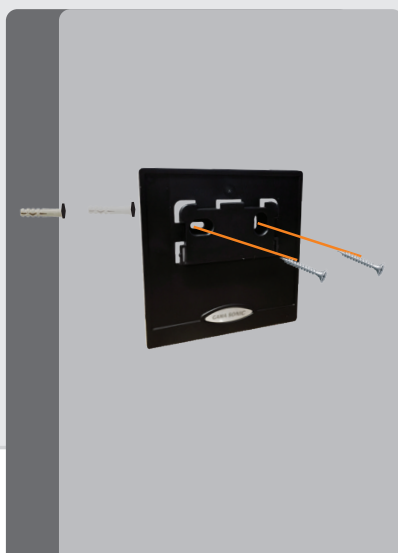
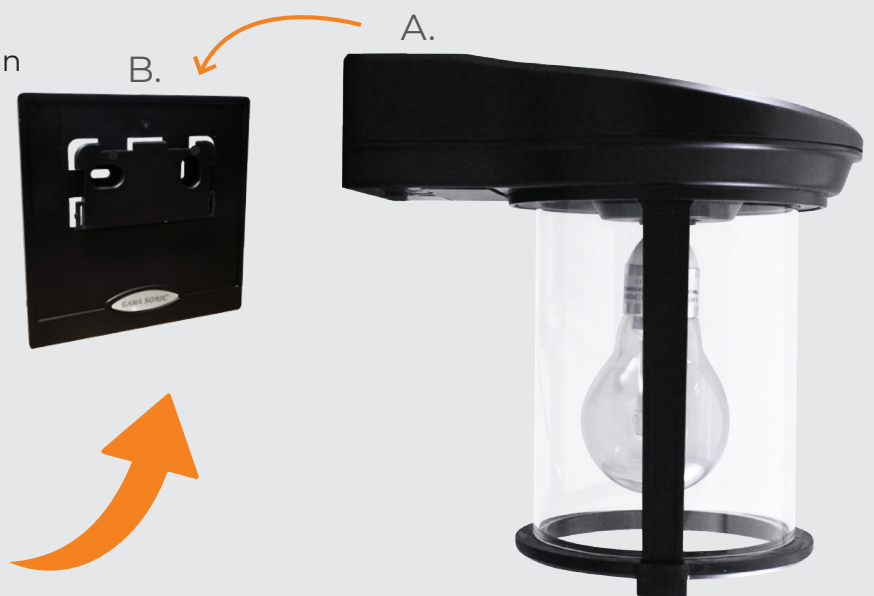

Fig.5





## Replacing the Batteries

Replacement batteries are available  
at [www.gamasonic.com](http://www.gamasonic.com) or via our Toll free number: +1-800-835-4113

After several years of use, the battery may need replacing.

1. Remove lamp from wall bracket
2. Flip the lamp over and unscrew the battery compartment to remove the battery (Fig. 6).
3. Unclip the connector and remove the old battery.
4. Clip on new battery and install into the battery compartment.
5. Insert the new battery and close the compartment, then re-install.

This lamp takes a 3.2V/1500 mAh Li-Ion battery pack (GS32V15). Replacement batteries can be purchased through our authorized dealers or by going to [www.gamasonic.com](http://www.gamasonic.com)



**WARNING:** Do not dispose of Li-Ion batteries in the regular trash, municipal waste stream or by fire as batteries may leak or explode. Do not open, short circuit, or mutilate batteries as injury may occur. Preserve our environment by recycling Li-Ion batteries or disposing of them in accordance with local, State and federal regulations. Do not mix old and new batteries.

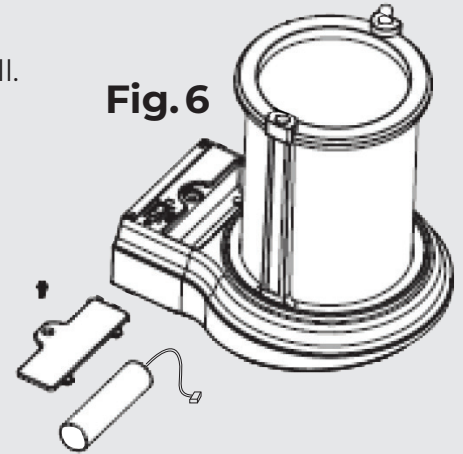

## Maintenance

Clean the solar module regularly with a damp towel to guarantee optimum performance of the solar panel. Do not use any type of solvent for cleaning and be careful not to put too much pressure on the module while cleaning.

## Troubleshooting

If your solar charged light does not come on at dusk despite observance of all the instructions, please try the following steps:

1. Make sure that the solar light is not being affected by any other light source.
2. Ensure the solar light is not positioned in the shade during the day.
3. Make sure the switch in the lamp head is in the "LOW" or "HIGH" position.
4. Check that the batteries are installed correctly.

**NOTE:** The performance of the solar light will vary with the time of year. It will deliver longer duration when it has had a full day in the sun rather than a day in overcast weather.



**WINTERTIME TIPS:** For optimal performance, be sure to remove any snow or debris accumulation from solar panel(s). A solar panel free of debris will charge the batteries much more efficiently.

**WARNING:** Please keep out of reach of children.

