

# TEAR SHEET

## Leeds Small Round Sconce

Item # CS 2605CGD

Designer: Christopher Spitzmiller

Height: 8.25"

Width: 8.25"

Extension: 3.75"

Backplate: 4.5" Round

Finishes: CGD, IVO, OSB, SHG

Socket: E12 Candelabra

Wattage: 40 C11

Weight: 8 Pounds

Note: Reactive Ceramic Glazes Will Vary in Color and Texture

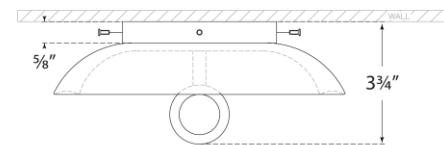

Top View

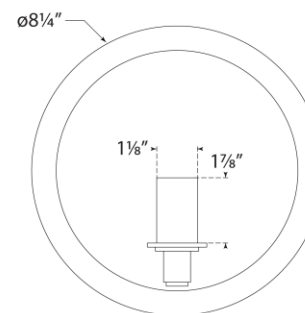

Front View

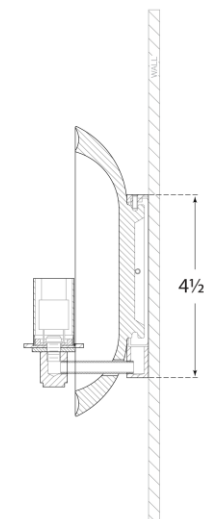

Side View