

Installation guide for
Guide d'installation pour

dals

1 877 430 1818
www.dals.com

Download the free Dals Connect app
Télécharger l'application gratuite Dals Connect

ORBIT
DCP-SPT6-BK



MODEL / MODÈLE	WATTS	LUMENS	KELVIN	INPUT / ENTRÉE	DIMMABLE*
DCP-SPT6	10W	540 lm	RGB + CCT 2200-4000K	24VDC	✓

*Dals Connect App™ / Application Dals Connect™



Landscape transformer, model **DCP-TR60-BK**, **DCP-TR200-BK** or **DCP-PTR36** is required for installation. Sold separately.
Transformateur pour appareils d'éclairage paysager, modèle **DCP-TR60-BK**, **DCP-TR200-BK** ou **DCP-PTR36** est requis pour l'installation. Vendu séparément.

ITEMS INCLUDED IN THE BOX / ARTICLES INCLUS DANS LA BOÎTE

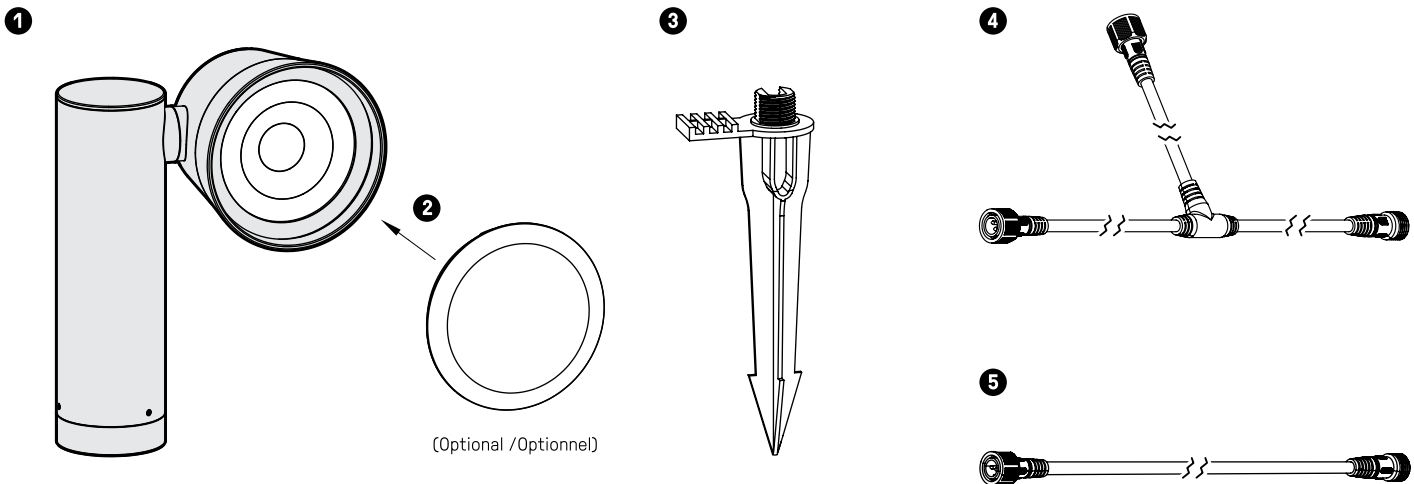

1 6" LED landscape spotlight
Luminaire de sentier DEL de 6"

2 120° Frosted lens
Lentille givrée 120°

3 Ground stake
Piquet de terre

4 6" T-connector
Connecteur en T de 6"

5 6' Extension cable
Câble d'extension de 6'

COMPATIBLE ACCESSORIES (SOLD SEPARATELY):
ACCESSOIRES COMPATIBLES (VENDUS SÉPARÉMENT) :

DCP-TR60-BK: Transformer / Transformateur - Max. 60W
DCP-TR200-BK: Transformer / Transformateur - Max. 200W
DCP-PTR36: Plug-in driver / Transformateur enfichable - 36W
DCP-ACC-MS12: Metal ground stake 12" / Piquet de terre en métal 12"
DCP-ACC-MS06: 6" metal stake / Piquet de terre en métal de 6"

DCP-ACC-MB: Mounting bracket / Support de montage
DCP-EXT20FT: 20' extension cable / Câble d'extension de 20'
DCP-EXT6FT: 6' extension cable / Câble d'extension de 6'
DCP-EXT-T: 6" T-connector / Connecteur en T de 6"
DCP-SPTTEXT14: 14" extension tube / Tube d'extension de 14"

WARRANTY / GARANTIE

DALS offers a 5 year warranty from the date of purchase which covers repairs or replacements of defective parts of the housing, optics, and electronics.
To contact DALS customer service call 1 877 430 1818 or send an e-mail to info@dals.com.

DALS offre une garantie de 5 ans à partir de la date d'achat qui couvre la réparation ou le remplacement des pièces du boîtier, ainsi que les pièces optiques et électroniques défectueuses. Pour contacter le service à la clientèle de DALS, composez le 1 877 430 1818 ou envoyez un courriel à info@dals.com.

Installation guide Guide d'installation

ORBIT
DCP-SPT6-BK



BEFORE YOU START

BEFORE STARTING INSTALLATION, SHUT THE LINE FEED POWER OFF USING THE CIRCUIT BREAKER.
Instructions pertaining to a risk of fire, electric shock or injury to persons. Installation must be done according to local electrical codes.
Installation should be done by a certified electrician.



AVANT DE COMMENCER

AVANT DE DÉBUTER L'INSTALLATION, COUPER L'ALIMENTATION DU FIL DU SECTEUR À L'AIDE DU DISJONCTEUR.
Ces instructions se rapportent à un risque d'incendie, de chocs électriques ou de blessures corporelles.
L'installation doit être effectuée conformément aux codes électriques locaux. L'installation devrait être effectuée par un électricien qualifié.

Installation with ground stake Installation avec piquet de terre

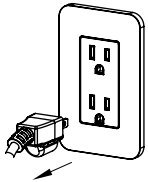

- 1 Make sure the power to the transformer is turned off.
S'assurer que l'alimentation du transformateur est coupée.

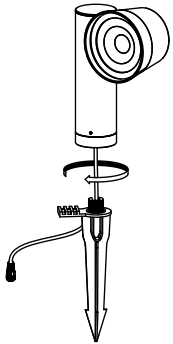

- 2 Position the wire through the stake slot then secure the fixture on the stake.
Positionner le fil dans la fente du piquet puis fixer le luminaire sur le piquet.

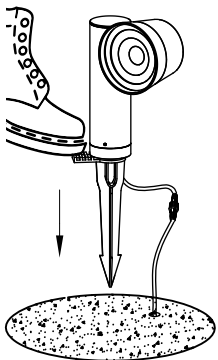

- 3 With your foot, insert the stake into the ground.
Avec votre pied, insérer le piquet dans le sol.

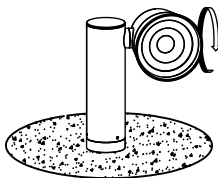

- 4 Rotate the fixture head to the desired orientation.
Tourner la tête du luminaire pour obtenir l'orientation souhaitée.

- 5 Turn the power back on.
Rétablir le courant.

Multiple devices installation Installation de multiples appareils

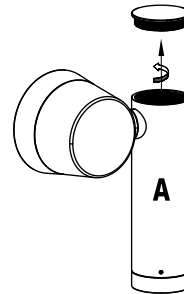

- 1 Unscrew the top end cap to reveal the daisy chain connector inside the tube.
Dévisser l'embout supérieur pour révéler le connecteur en série à l'intérieur du tube.

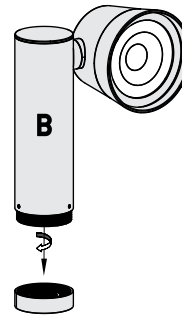

- 2 Remove the stake adapter at the bottom of the (B) fixture.
Retirer l'adaptateur de piquet au bas du luminaire (B).

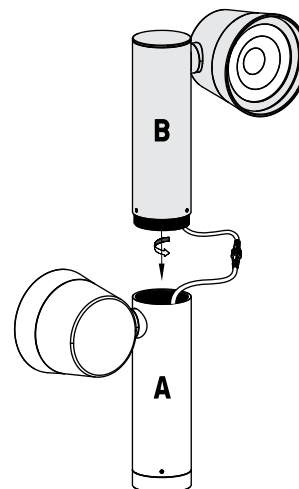

- 3 Make the connections then stack the (B) fixture on top of the (A) fixture.
Effectuer la connexion puis empiler le luminaire (B) sur le luminaire (A).

Notice:
Loosen the set screws to redirect the fixture.
Desserrer les vis de réglage pour réorienter le luminaire.

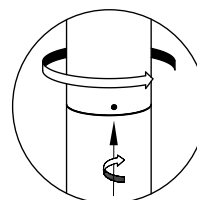

Dals Connect

To pair your product, follow the steps on the App
Pour connecter votre produit, suivre les étapes sur l'application

dals
1 877 430 1818
www.dals.com
INS_DCP-SPT6

FCC COMPLIANCE

FCC STATEMENT

1. This device complies with Part 15 of the FCC Rules. Operation is subject to the following two conditions: (1) This device may not cause harmful interference, and (2) This device must accept any interference received, including interference that may cause undesired operation.
2. Changes or modifications not expressly approved by the party responsible for compliance could void the user's authority to operate the equipment.

This equipment has been tested and found to comply with the limits for a Class B digital device, pursuant to part 15 of the FCC Rules. These limits are designed to provide reasonable protection against harmful interference in a residential installation. This equipment generates, uses and can radiate radio frequency energy and, if not installed and used in accordance with the instructions, may cause harmful interference to radio communications. However, there is no guarantee that interference will not occur in a particular installation. If this equipment does cause harmful interference to radio or television reception, which can be determined by turning the equipment off and on, the user is encouraged to try to correct the interference by one or more of the following measures:

- Reorient or relocate the receiving antenna.
- Increase the separation between the equipment and receiver.
- Connect the equipment into an outlet on a circuit different from that to which the receiver is connected.
- Consult the dealer or an experienced radio/ TV technician for help.

FCC Radiation Exposure Statement:

This equipment complies with FCC radiation exposure limits set forth for an uncontrolled environment. In order to avoid the possibility of exceeding the FCC radio frequency exposure limits, Human proximity to the antenna shall not be less than 20cm (8 inches) during normal operation

IC COMPLIANCE

CANICES-5(*)/NMB-5(*)

Industry Canada Notice

This device contains licence-exempt transmitter(s)/receiver(s) that comply with Innovation, Science and Economic Development Canada's licence-exempt RSS(s). Operation is subject to the following two conditions:

- (1) This device may not cause interference.
- (2) This device must accept any interference, including interference that may cause undesired operation of the device

- 2.Changes or modifications not expressly approved by the party responsible for compliance could void the user's authority to operate the equipment.

CONFORMITÉ IC

Avis d'Industrie Canada

Cet appareil contient des émetteurs / récepteurs exemptés de licence conformes aux RSS (RSS)d'Innovation, Sciences et Développement économique Canada. Le fonctionnement est soumis aux deux conditions suivantes :

- (1) Cet appareil ne doit pas causer d'interférences.
- (2) Cet appareil doit accepter toutes les interférences, y compris celles susceptibles de provoquer un fonctionnement indésirable de l'appareil.

- 2.Cet appareil numérique ne dépasse pas les Rélements sur l'interférence radio par un appareil numérique de classe B stipulées dans les Règlement sur l'Interférence radio d'industrie Canada.

ISED RF Exposure statement

This equipment complies with ISED radiation exposure limits set forth for an uncontrolled environment. In order to avoid the possibility of exceeding the ISED radio frequency exposure limits, Human proximity to the antenna shall not be less than 20cm (7.9 inches) during normal operation