

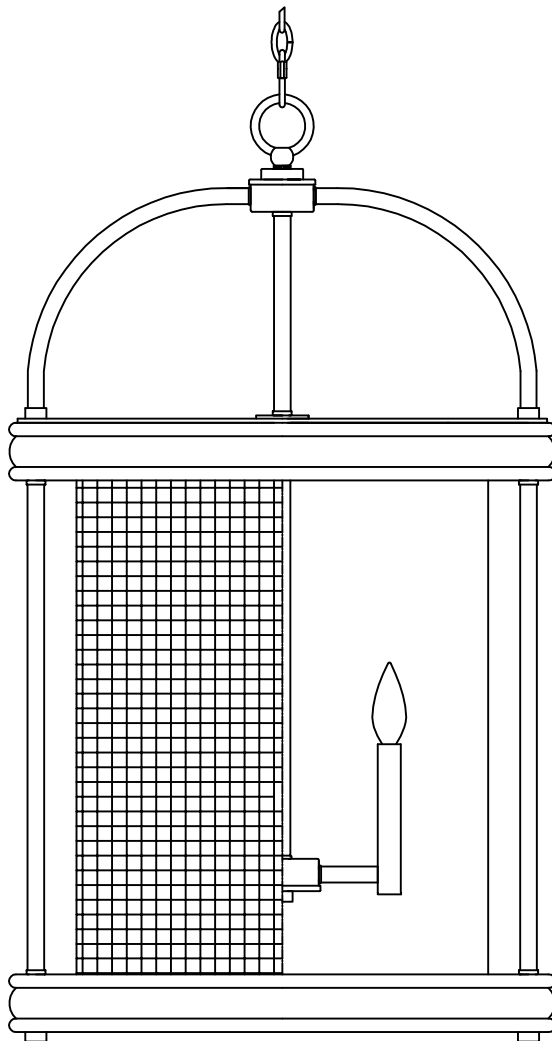

PRODUCT NAME: Lancaster 6 Light Lantern
ITEM NUMBER: 32387DWBK

Please consult a qualified electrician for hanging fixture and wiring.



Bulb (not included): 6*60W E12 Bulbs

IMPORTANT: Turn off the power at the main fuse or circuit breaker box before starting installation

Locate all hardware & components before discarding packaging

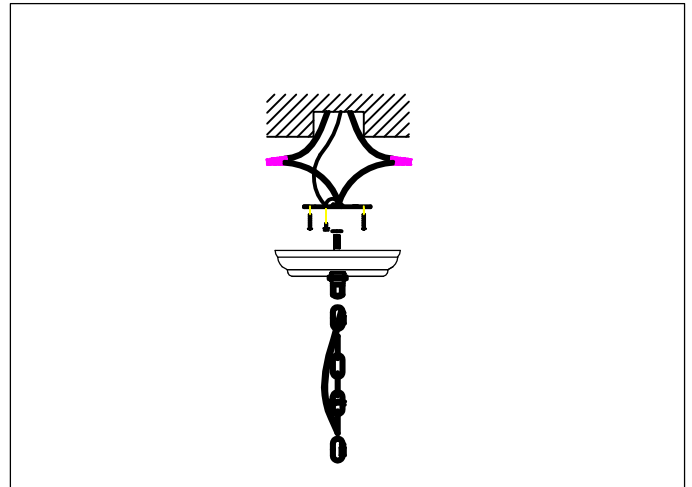
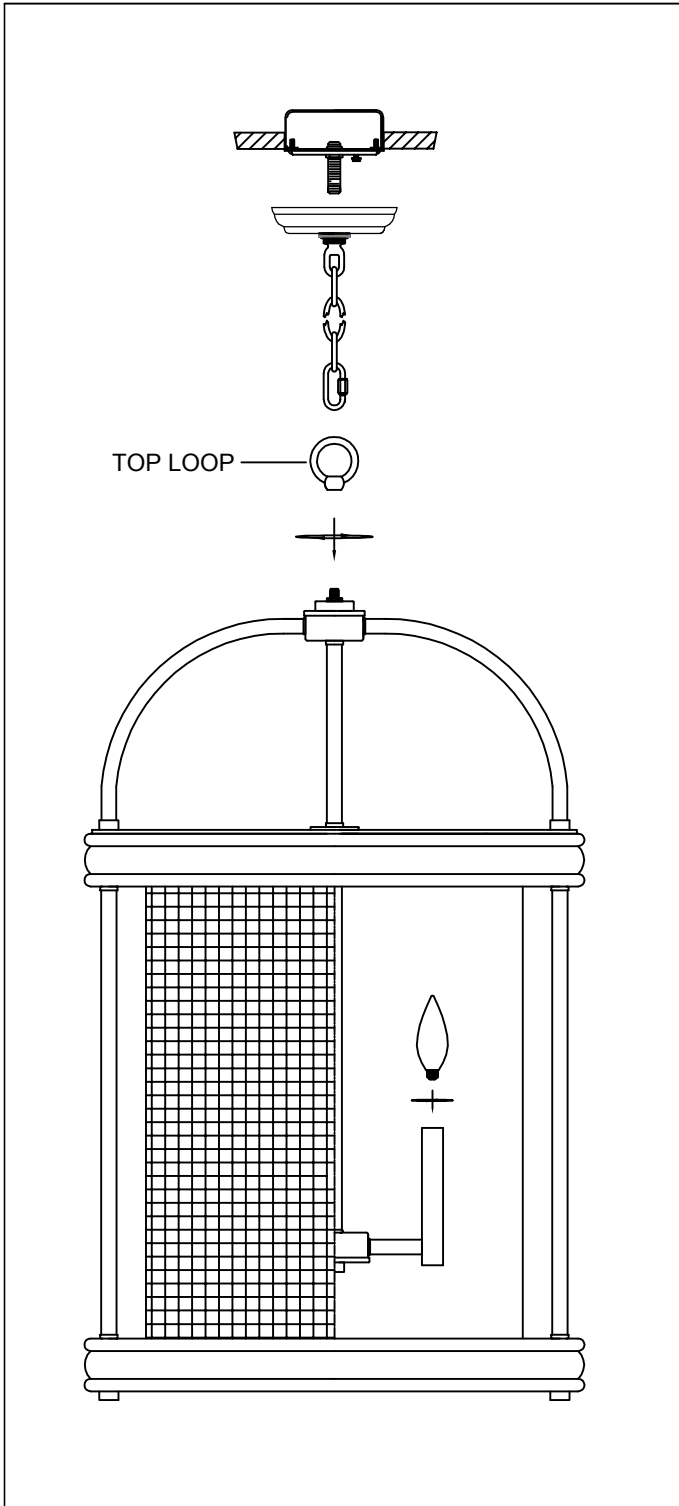

1. Remove mounting bracket from fixture and install to electrical box.
2. Attach appropriate amount of chain to loop on center stem to achieve desired mounting height. Thread wire through every 3rd loop of chain.
3. Remove screw ring from collar loop and slide down chain. Place canopy onto chain. Install nipple and cross bar into top of chain loop.
4. Wire fixture to wires in outlet box. Copper wire is for Ground.
5. Pull canopy through screw ring up chain to ceiling and tighten securely.

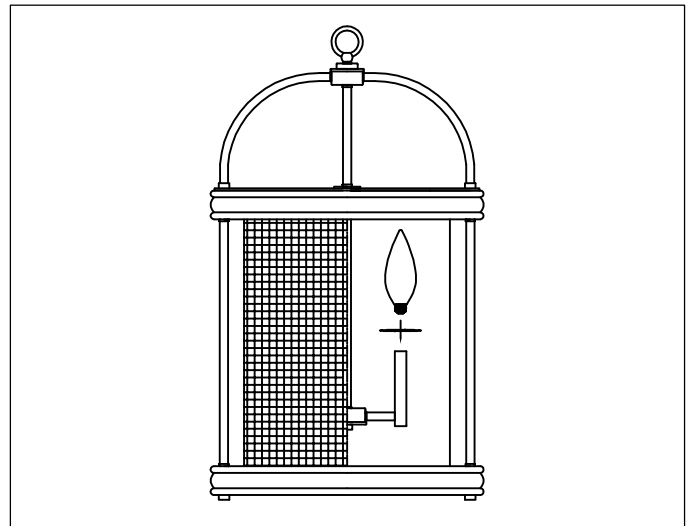

6. Install max 60W E12 bulbs.

Cleaning & Care:
Clean with soft cloth and a mild detergent.
Do not use abrasive cleaner