

# LED Product Information and Warnings

## Important

- **Always disconnect the power before installing or replacing bulbs and before cleaning or other maintenance.**
- **Consult a qualified, licensed electrician to ensure correct branch circuit conductor.**
- Please read all included assembly instructions and warnings carefully before installation. Contact Customer Service if you have any questions or concerns. Before installation, please confirm that the fixture is compatible with your supply voltage and dimming system, if present.
- LEDs are highly sensitive electronic devices, and must be treated with care. Do not open any factory sealed compartments, and avoid touching the LEDs with your hands or any object.
- Although all our fixtures are equipped with protective devices, LED fixtures are vulnerable to power surges and supply variations. Do not install LED fixtures on the same circuit as any motors, appliances, or HVAC systems.
- Do not remove or bypass any LED Driver or Transformer that is provided with the fixture, and do not replace or substitute with another power supply.
- Remote LED Driver or Transformer installation must be done by a licensed electrician and in accordance with local codes. Remote installations should be in an accessible location, as close to the fixture as possible.
- Fixtures must be wired in parallel on independent leads; do not "daisy chain" multiple fixtures together or wire them in series.
- All factory-made splices and connections must remain intact. LED circuits are carefully designed and built, and improper connections may damage the fixture.
- The ends of coaxial pendant cords have been precisely stripped and split at the factory and must not be field cut. Excess cord or cable should be neatly coiled and reserved in the fixture canopy.
- Any mounting hardware is provided for your convenience and should be used with discretion. Always use the appropriate hardware for the mounting surface.

December 3, 2015

# Assembly Instructions

7254, 7256

## INSTRUCTIONS D'INSTALLATION

Sideways Series - 24" LED Sconce, 36" LED Sconce

### Important

- **Always disconnect the power before installing or replacing bulbs and before cleaning or other maintenance.**
- **Consult a qualified, licensed electrician to ensure correct branch circuit conductor.**  
*Consulter un électricien qualifié pour vous assurer que les conducteurs de la dérivation sont adéquats.*

1. Shut off power to the outlet box (A).
2. Make appropriate electrical connections using wire nuts:
  - a. Connect the transformer's (B) live wire (black) to the live outlet box wire.
  - b. Connect the transformer's (B) neutral wire (white) to the neutral outlet box wire.
  - c. Connect the fixture's ground wire (green or uncoated) to the ground outlet box wire. If no ground is present in outlet box, connect fixture's ground wire to the mounting plate (C) using the green screw (included).
  - d. Carefully place connections and transformer (B) in outlet box (A).
3. Attach the mounting plate (C) to the outlet box (A), secure with outlet box screws (D). Use anchors (E) and screws (F) to secure ends of mounting plate to mounting surface.
 

**For Wet Location Use:** Fixture must be installed in a vertical orientation with the drain hole positioned on the bottom end and mounted minimum 4' above the ground.
4. Install the fixture (G) to the mounting plate (C). Secure with mounting screws (H) using included Allen wrench (I).
 

**For Wet Location Use:** Included gaskets must be used under the mounting screws.
5. **For Wet Location Use:** Place a small bead of silicone or water proof caulk (not included) around the fixture (E) where it comes into contact with the wall.
6. Restore power to the fixture.



7254

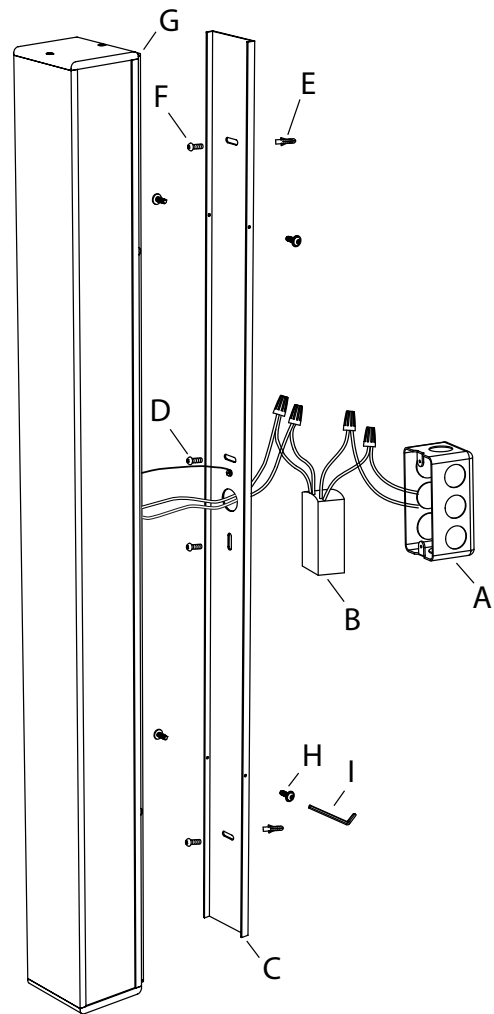

7256

### Note

- **This fixture is dimmable with Electronic Low Voltage (Trailing-Edge) type dimmers only.**

### Care Instructions

- **Dusting:** Use a clean, dry cloth.
- **Cleaning:** To protect the finish, avoid any harsh abrasives or chemicals.