



**SCHONBEK®**

**CHANTANT**  
**CH2401N- \_\_ \_\_ H**



**T**HIS DESIGN IS THE PROPRIETARY  
TRADE DRESS/TRADE MARK OF  
SWAROVSKI LIGHTING, LTD.

6 Lights  
Diameter: 24"  
Height: 20-1/2"  
Hanging Weight: 14lbs.



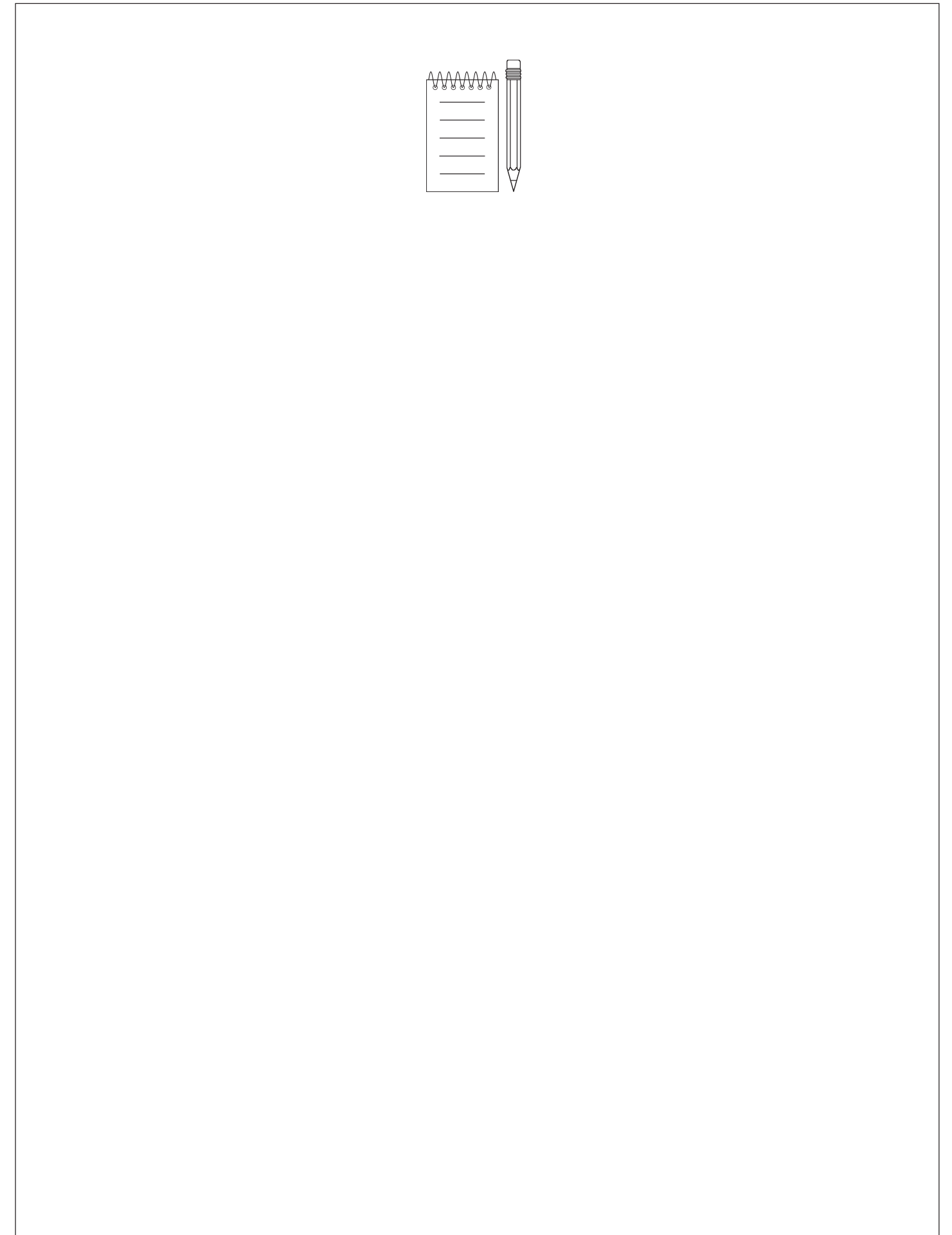
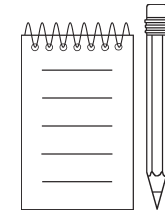
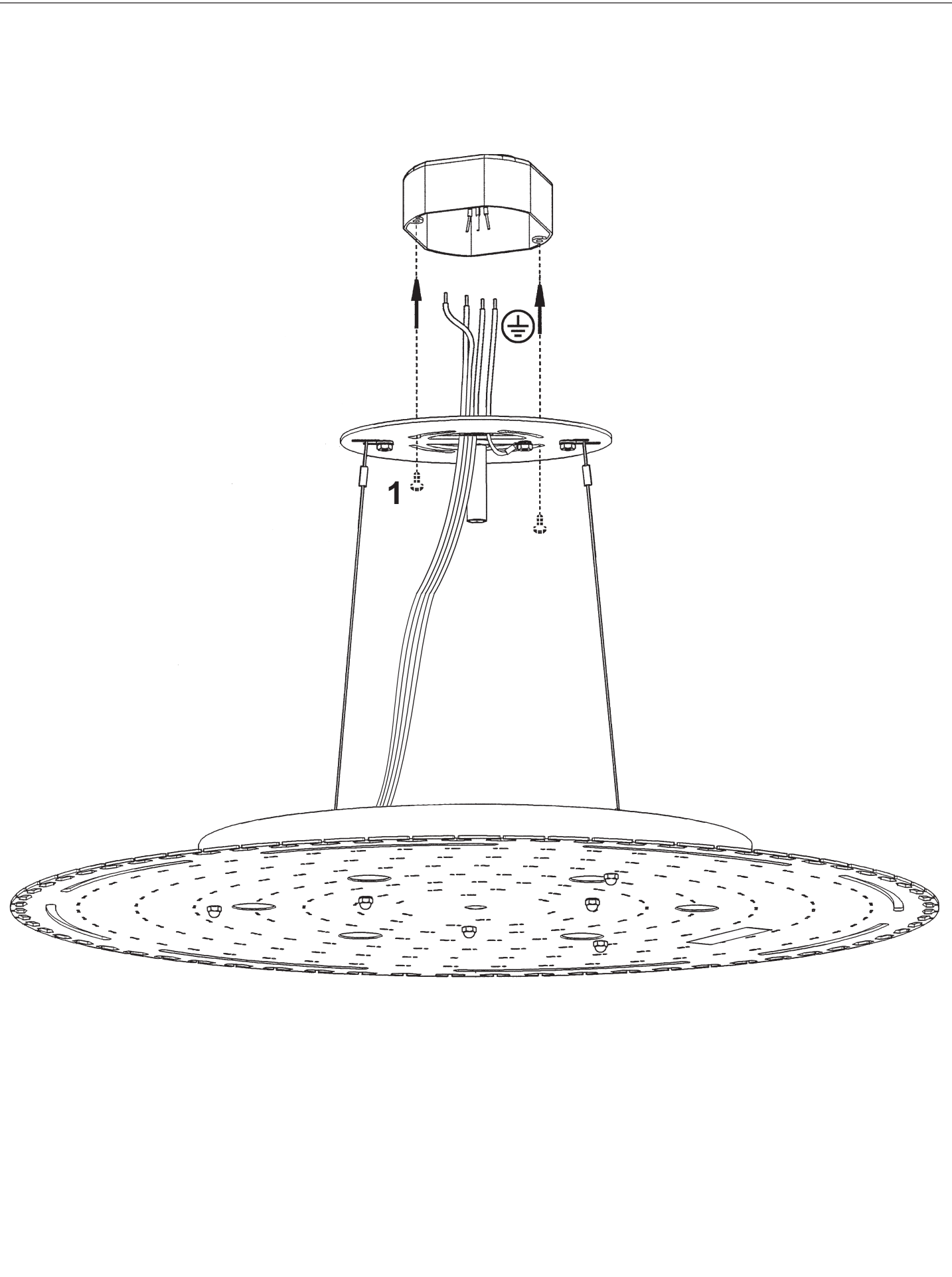

**SCHONBEK®**

MAX <u>35</u> W		110-120 V						

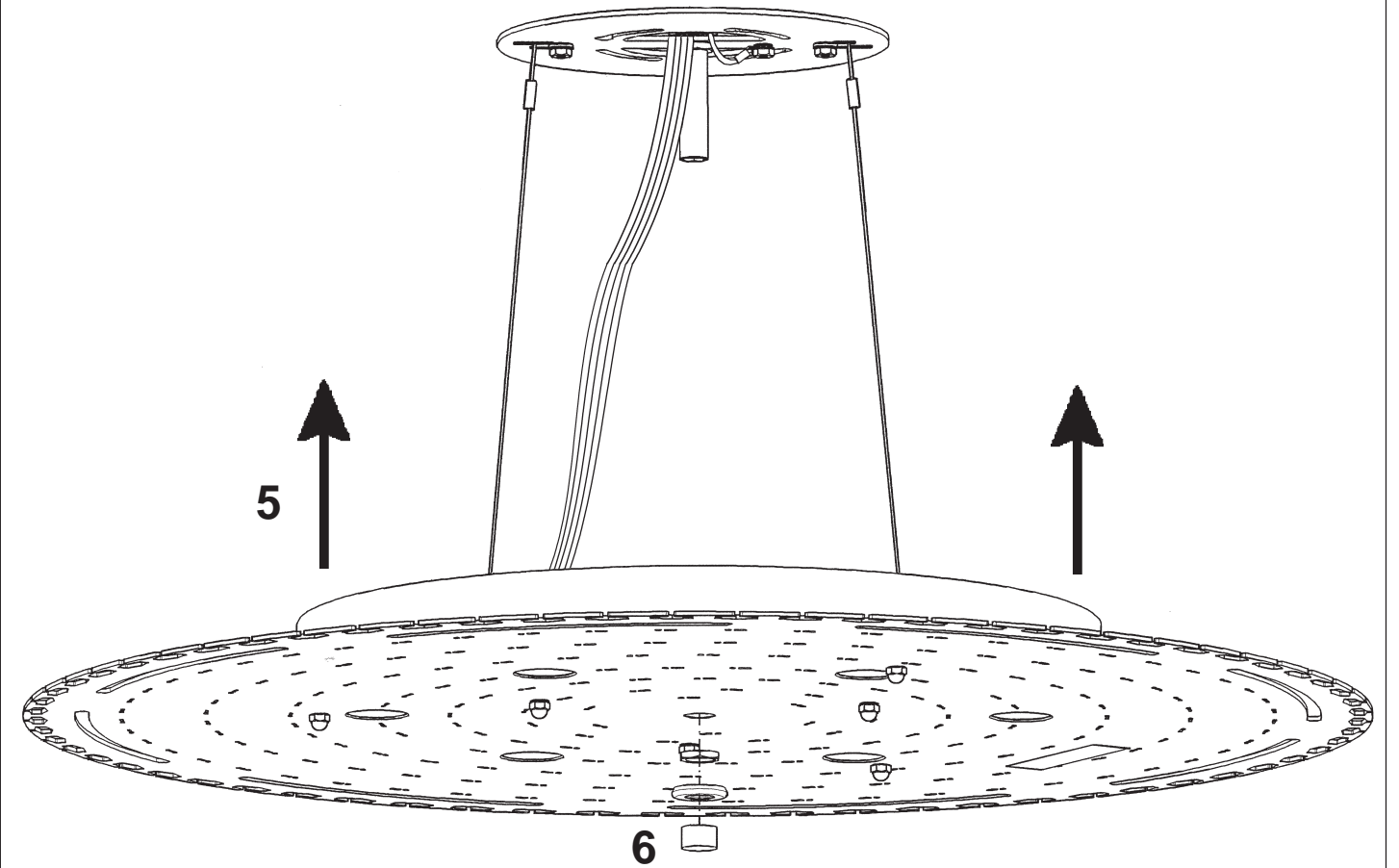
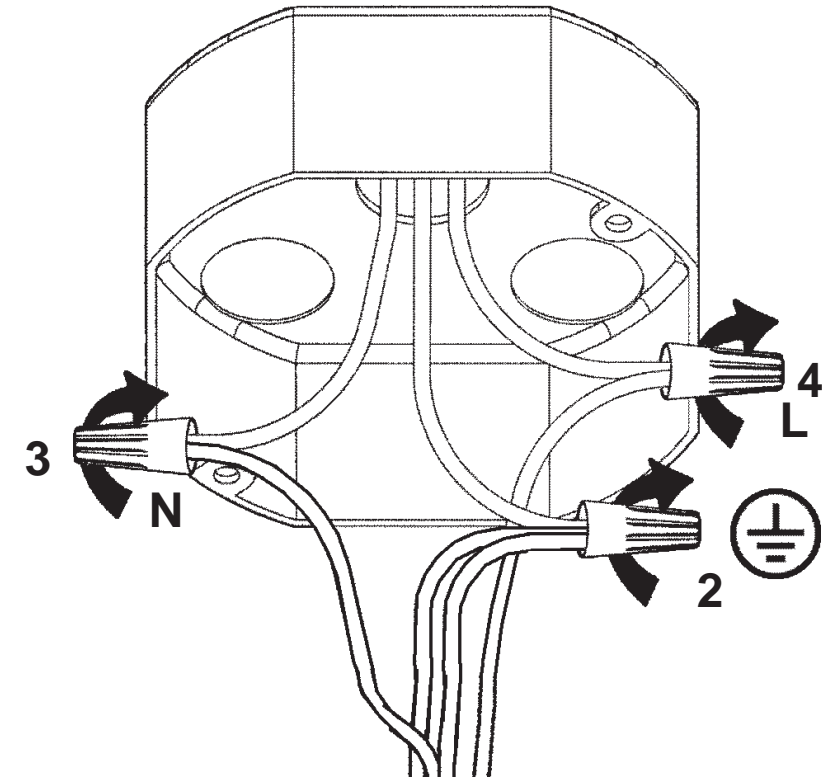
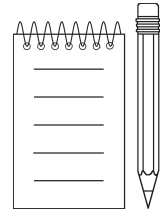

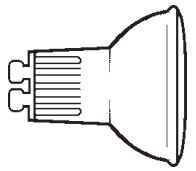

6 X  : GU10 35W MAX 

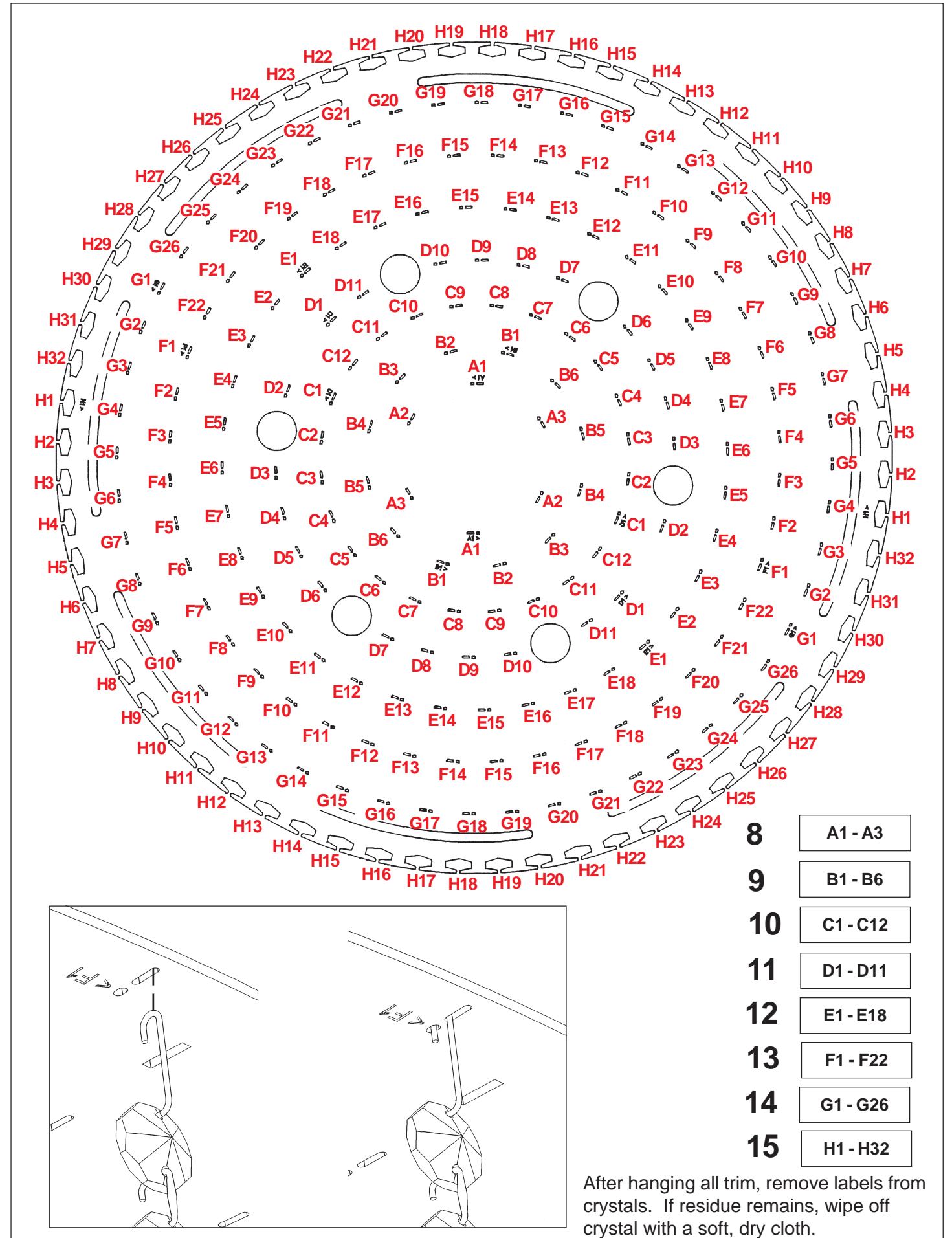
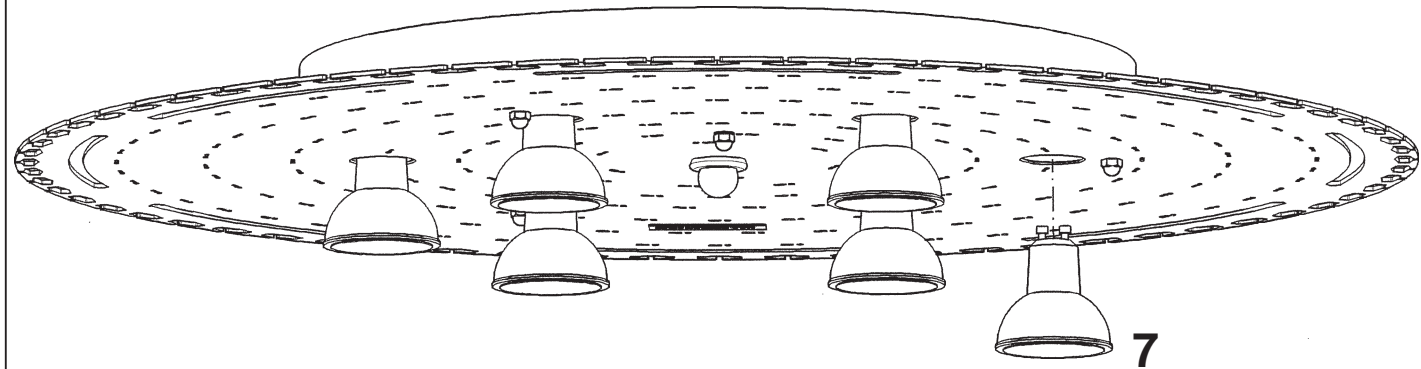

- 8** A1 - A3
- 9** B1 - B6
- 10** C1 - C12
- 11** D1 - D11
- 12** E1 - E18
- 13** F1 - F22
- 14** G1 - G26
- 15** H1 - H32

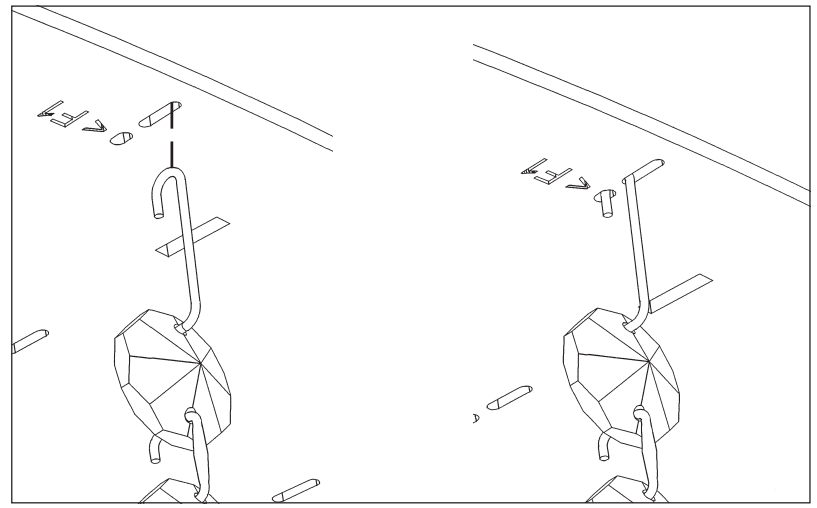

After hanging all trim, remove labels from crystals. If residue remains, wipe off crystal with a soft, dry cloth.