

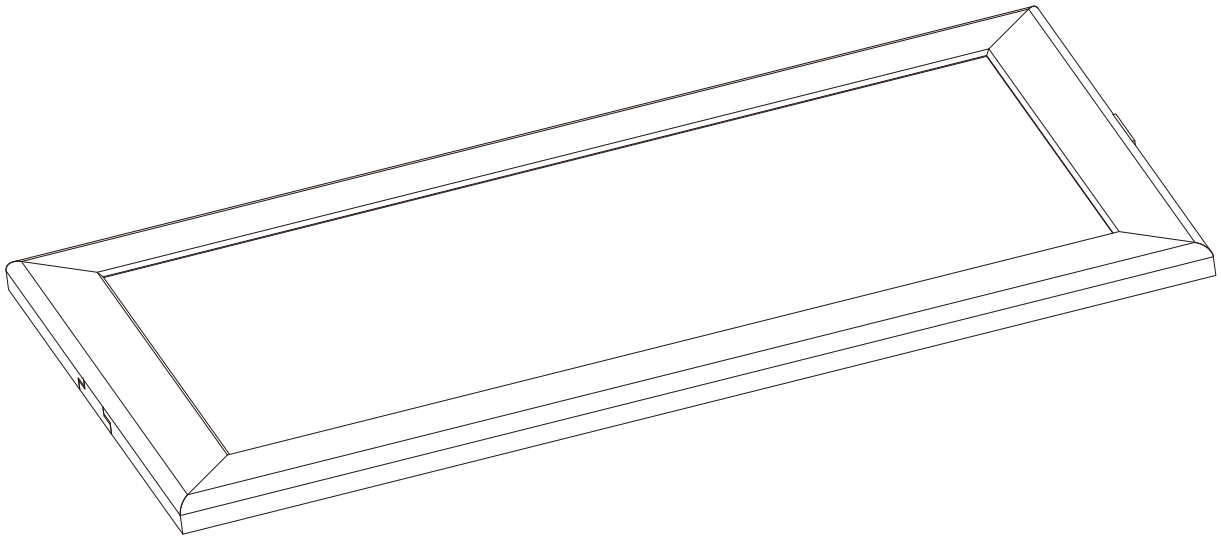

PRODUCT NAME: "Slim Line" MX-L120-SL Under Cabinet light



ITEM NUMBER: 88900 88903  
88901 88904  
88902



Please consult a qualified electrician for hanging fixture and wiring.

Light Source : LED Integrated 3W/6W/12W/18W/24W  
24V/60Hz

Made in China / Hecho en China /Fabrique en China

Before Getting Started	Antes de comenzar	Avant de commencer
Read the instructions carefully prior to assembling the product.	Lire attentivement les instructions avant d'assembler le produit.	Lea atentamente las instrucciones antes de ensamblar el producto.
When you open the package with a sharp tool like a cutter knife, be careful not to damage the components inside.	Lorsque vous ouvrez le paquet avec un outil pointu comme un couteau de coupe, veillez à ne pas endommager les composants à l'intérieur.	Cuando abra el paquete con una herramienta afilada como un cuchillo de corte, tenga cuidado de no dañar los componentes dentro.
Carefully remove all packaging materials and retain for future use.	Retire con cuidado todos los materiales de embalaje y consérvelos para usarlos en el futuro.	Retirez soigneusement tous les matériaux d'emballage et conservez-les pour un usage ultérieur.
Keep all hardware parts and packaging out of reach of small children.	Conservez toutes les pièces matérielles et les emballages hors de portée des petits enfants.	Mantenga todas las piezas y embalajes de hardware fuera del alcance de los niños pequeños.
Choose a clean, level, spacious assembly area. Avoid hard surfaces that may damage the product.	Choisissez une zone d'assemblage propre, de niveau et spacieuse. Évitez les surfaces dures qui pourraient endommager le produit.	Elija una zona de ensamblaje limpia, nivelada y espaciosa. Evite superficies duras que puedan dañar el producto.
Ensure that you have all required contents for complete assembly.	Assurez-vous que vous avez tous les contenus requis pour l'assemblage complet.	Asegúrese de que tiene todos los contenidos necesarios para el ensamblaje completo.
Take care when lifting. Assemble the product in close proximity to where you intend to position the item.	Prenez soin de soulever. Assemblez le produit à proximité de l'endroit où vous comptez positionner l'élément.	Tenga cuidado al levantar. Ensamble el producto cerca de donde tiene la intención de posicionar el artículo.
Do not over tighten the screws and bolts as this may damage the threads.	Ne serrez pas trop les vis et les boulons car cela pourrait endommager les filets.	No apriete excesivamente los tornillos y pernos, ya que esto puede dañar los hilos.
Do not let children play with this product.	No permita que los niños jueguen con este producto.	Ne laissez pas les enfants jouer avec ce produit.
 Risk of suffocation! Keep any packaging materials away from children.	 ¡Riesgo de sofocación! Mantenga los materiales de embalaje lejos de los niños.	 Risque d'asphyxie! Tenez tous les matériaux d'emballage à l'écart des enfants

Lamp Care Instructions	Instrucciones de lámparas	Entretien de la lampe
Carefully read through the instruction sheet before assembly and using the product.	Lea cuidadosamente la hoja de instrucciones (si fue proporcionada) antes de armar y utilizar la lámpara.	Avant de procéder à l'assemblage et à l'utilisation de la lampe, lisez attentivement le mode d'emploi.
Caution there is a risk of shock. Disconnect from power source before assembling or cleaning.	Peligro por descarga eléctrica. Desconecte la lámpara de la fuente de electricidad antes de armarla o limpiarla.	Pour éviter tout risque d'électrocution, débranchez la lampe de la prise électrique avant de procéder à l'assemblage ou au nettoyage de la lampe.
Switch off, unplug and allow bulb to cool before replacing bulb or cleaning.	Apáguela, desenchúfela y deje que la bombilla se enfríe antes de reemplazarla o limpiarla.	Avant de remplacer ou de nettoyer l'ampoule, éteignez et débranchez la lampe.
Only use the recommended bulb type and do not exceed the maximum wattage as it could cause fire.	Solo utilice el tipo de bombilla recomendado y no exceda la potencia eléctrica máxima ya que puede causar un incendio.	Afin d'éviter tout risque de feu, utilisez le type et la puissance d'ampoule recommandés.
Do not plug the product in if cord is torn or frayed.	No conecte la lámpara si el cable eléctrico está dañado o deshilachado.	Ne branchez pas la lampe si son cordon d'alimentation est déchiré ou effiloché.



Cleaning & Maintenance	Limpieza y mantenimiento	Nettoyage et maintenance
On polished finishes, often using talc powder reduces the appearance of fingerprints and other smudges.	En acabados pulidos, a menudo usando polvo de talco reduce la aparición de huellas dactilares y otras manchas.	Sur les finitions polies, souvent en utilisant la poudre de talc réduit l'apparence des empreintes digitales et d'autres taches.
For respective shade surfaces, use the appropriate cleansers, i.e. glass cleaner, acrylic polish, and wood polish.	Para las respectivas superficies de sombra, utilice los limpiadores apropiados, es decir, limpiador de vidrio, esmalte acrílico y pulido de madera.	Pour les surfaces d'ombrage respectives, utilisez les nettoyeurs appropriés, c'est-à-dire le nettoyeur pour vitres, le Vernis acrylique et le vernis à bois.
Clean with soft cloth and a mild detergent. DO not use abrasive cleaner.	Utilice un trapo limpio, suave y seco que no raye ni manche la superficie cuando quite el polvo.	Nettoyer avec un chiffon doux et un détergent doux. N'utilisez pas de nettoyeur abrasif.
Periodically (every 90 days) make sure that the screws are fully tightened.	Periódicamente (cada 90 días) asegúrese de que los tornillos estén bien apretados.	Périodiquement (tous les 90 jours), assurez-vous que les vis sont bien serrées.
Prolonged exposure to heat sources may cause glazing, melting and scorching, or even cause color to fade.	La exposición prolongada a las fuentes de calor causa cristalización, derretimiento, quemadura y decoloración del tapizado.	Si le tissu subit une exposition prolongée aux sources de chaleur, il pourrait commencer à reluire, à roussir, à s'estomper ou même à se décolorer.

# EN Contents

Before getting started, ensure the package contains the following components:

Antes de comenzar, asegurese de que el paquete contenga los siguientes componentes:

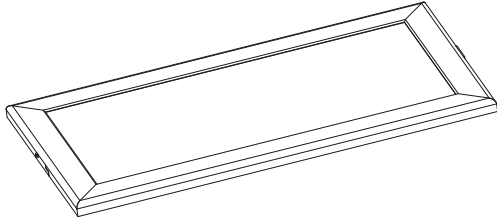
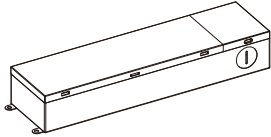
Avant de commencer, assurez-vous qu le paquet contient les composants suivants:

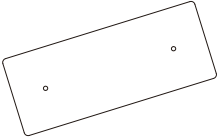
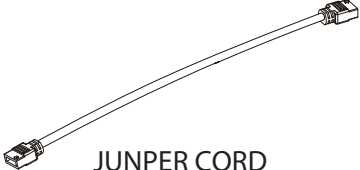
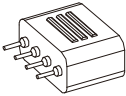
<b>A</b>	 LAMP	x1		
<b>B</b>	 HARD WIRE DRIVER (SOLD SEPERATELY)	x1		
<b>C</b>	 SCREW	x2		
<b>D</b>	 MOUNTING BRACKET	x1		
<b>E</b>	 JUNPER CORD (SOLD SEPERATELY)	x1		
<b>F</b>	 END TO END CONNETOR	x1		

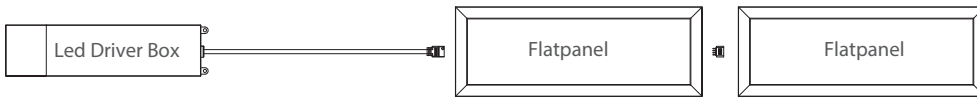

**If the cable is not long enough**

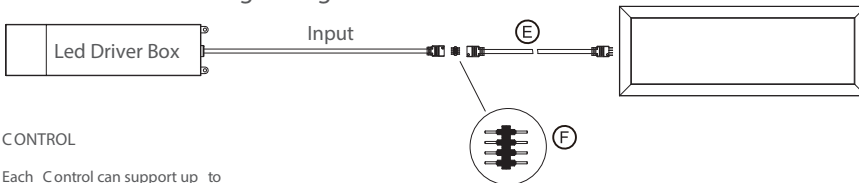

**CONTROL**

Each Control can support up to 96W per port.

Control has two input ports and two output ports that are controlled simultaneously.

**FOLLOW LOCAL ELECTRICAL CODES:**

Wires may be cut and spliced with appropriate gauge wire for extended runs. 14 gau. wire is recommended on runs longer than 3 feet. Keep wire runs as short as possible to maintain uniform and even light distribution across all panels. For a fully loaded system, the voltage drop for 14 gau. wire is 0.1 V/ft.

**TOTAL PANELS NOT TO EXCEED MAXIMUM SUPPLY WATTAGE**

Each 60 W power supply can support up to 60W of LED panels.

Each 96w power supply can support up to 100 W of LED Panels.

Mount power supply near 120V-277V household power supply.

**WATTAGE PER PANEL SIZE:**

- 6"-3W
- 12"-6W
- 24"-12W
- 36"-18W
- 48"-24W

**Identify components**

1. LED panel
2. Power supply
3. Mounting plate
4. Junction controller
5. Extension cable
6. Butt connector
7. Magnet Clips
8. Wire caps
9. Strain Relief
10. Screws

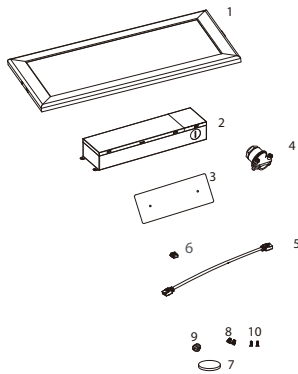

**Install Power Supply**

**Power Cord Installation:**

- 1 – Identify location to mount power supply.
- 2 – Remove 2 screws and cover from top of unit.
- 3 – Mount power supply to wall or cabinet using captivated screws. For installation into drywall, use hollow wall anchors (not provided).
- 4 – Install power cable to the power supply by pushing the connector into the receptacle on the power supply until you hear a click. Do not plug cable into power outlet until installation is complete.
- 5 – Insert provided red/black DC power cable into power supply by depressing tab and inserting cables firmly. Using wire connectors (provided), connect black & red supply wire to red cable and white & yellow supply wire to white cable.
- 6 – Reinstall cover.

**Hardwire Installation:**

**FOLLOW STEPS 4A-4C for Hardwire Installation**

4A - Determine appropriate wire and connectors to use based on local codes. Power supply knockouts are sized for 1/2" conduit.

4B - Remove appropriate knockout for power supply entry with a flathead screwdriver.

4C - Power supply is equipped with three orange quick connectors for 14-18 AWG solid wire only.

Connect ground supply line to the yellow wire. Connect white (common) supply to white power supply wire. Connect black (hot) supply to black power supply wire. Do not mix wire gauges. Pull gently on each wire lead to make sure connections are secured.

Continue with step 5 at left.

(continued on back)

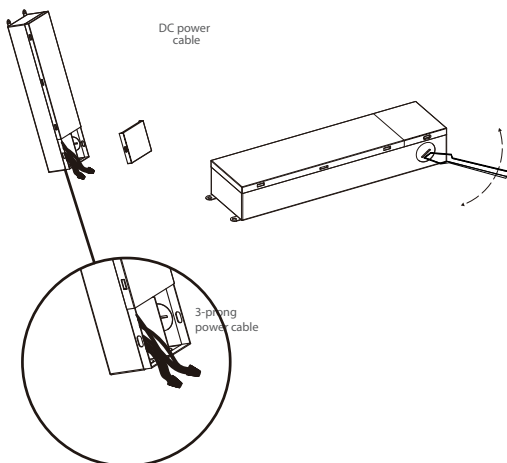

## LED Panel Installation:

1 – Locate LED panels fitting plate in desired location and fasten to fitting plate using provided screws.  
Note: Orient panel fitting plate so that the panel input socket is in the proper direction to mate with control cable.

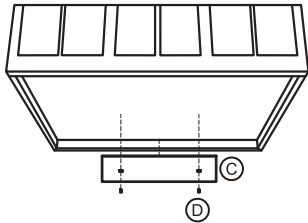

2 - Fasten to fitting plate using provided screws.

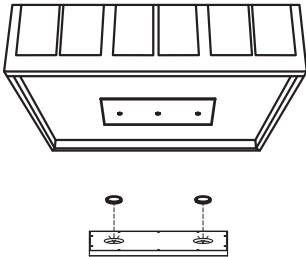

3- Using the magnet clips to fix in the hole of panel .

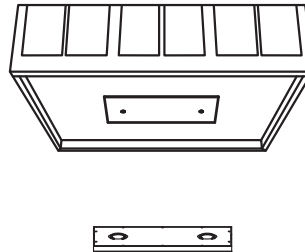

4 – Putting the flatpanel into the fitting plate directly and change the position to be the proper location to make sure the led flatpanel can be fasten enough.

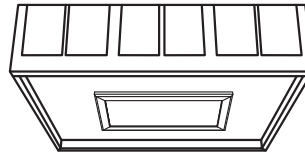

### CAUTION:

- Read all instructions before installing.
- Turn off power at main switch power supply prior to installation to prevent electrical shock.
- For display or under cabinet only. Not intended for ceiling use.
- System is intended for installation in accordance with National Electric Code, and local regulations. Consult with local inspector to assure compliance.
- Keep away from combustible materials such as plastic or paper products.
- Do not touch cover when light is on.  
Do not operate with missing or damaged wires.
- Retain instructions for future reference.

### Linkable using :

Add additional LED panels as necessary, connecting output of one panel to the input of the adjacent panel using either a 12" link cable or a direct connector. (NOTE: TOTAL PANELS NOT TO EXCEED POWER SUPPLY WATTAGE)