

**SAFETY INSTRUCTION**

IMPORTANT: NEVER attempt any work without shutting off the electricity.

- Always turn off power at fuse box prior to installation to prevent electrical shock.
- For installation and serviced by a qualified, licensed electrician.
- Install in accordance with national electric code, and local regulations.
- Consult with local inspector to assure compliance.

**CAUTION**

- Read all instructions before installing.
- Handle product with care.
- Do not modify or disassemble product beyond instructions or warranty will be void.
- Failure to follow safety warnings, and installation instruction will void the warranty
- This power supply is designed to work with only WAC InvisiLED Outdoor tape light.

**FEATURES**

- Protection: short circuit/over loading/over temperature
- 24VDC Output, 4A Max Output Current,  $\geq 0.9$  pf
- Ambient Temp:  $-20^{\circ}\text{C}$  TO  $45^{\circ}\text{C}$  ( $-4^{\circ}\text{F}$  TO  $113^{\circ}\text{F}$ )
- IP67 rated
- Full protection aluminum housing for dry, damp, and wet location

**PRODUCT DIMENSION:**

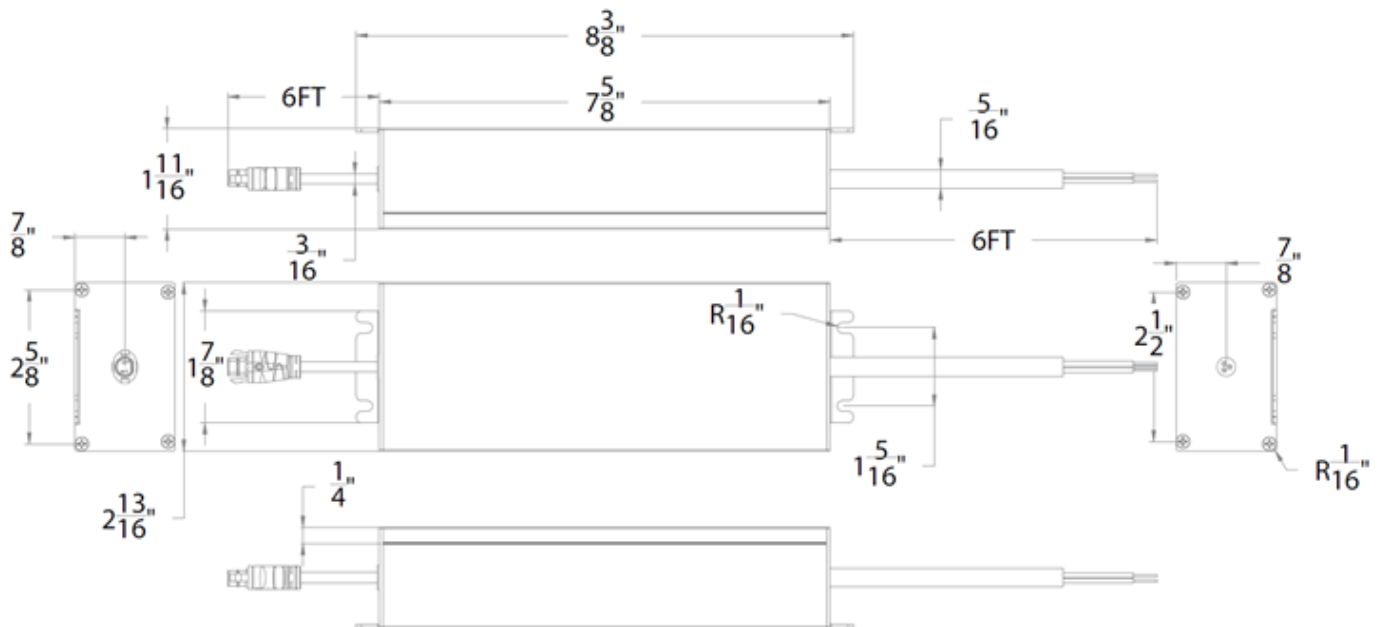

## WIRING AND INSTALLATION:

1. Turn Power off at circuit breaker

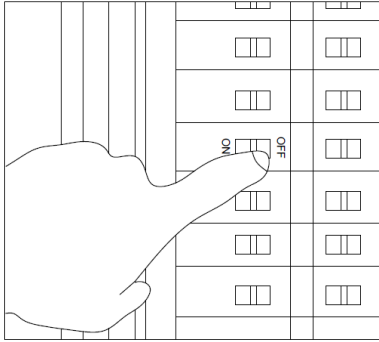

2. Mounting Enclosed 24VDC class 2 output remote power supply at desired location. Measure a distance between power supply to the beginning of the tape run and make sure that it is under 100ft. The allowed maximum distance of wires between the output of power supply to the beginning of tape is 100 ft. The minimum output gauge wire of power supply is 20 AWG.

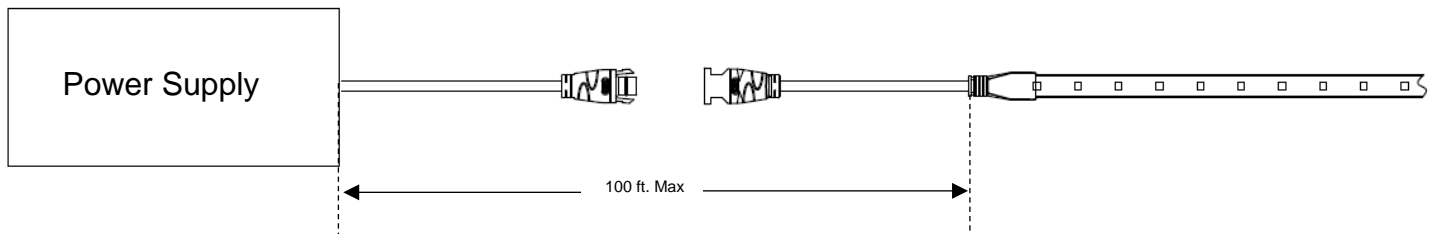

To extend the cable length between hard wire power supply or a wiring box to a tape section (if needed), InvisiLED Outdoor Joiner Cable (T24-WE-IC) can be used to join between sections as shown below:

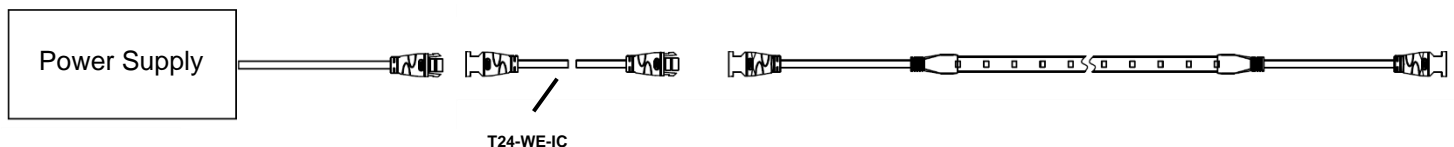

3. Connect electrical power feed wires to the outdoor tape.

- Using IP67 WAC Outdoor Rated Power Supply (PS-24DC-U96R-WE): the female and male connector have an edge marking on the top. Making sure to match the terminal correctly before pushing-in.

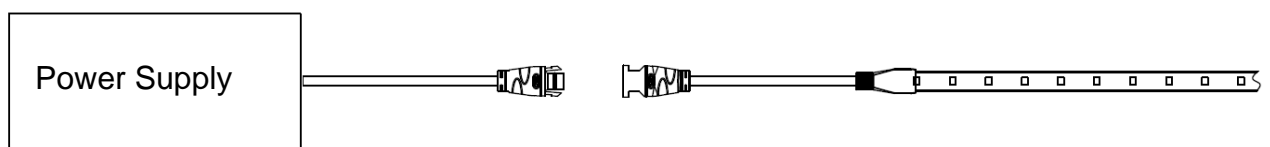

### Hard Wire:

- The power supply box has a separate line voltage, and low voltage wiring compartments.
- Trade size knock out are provided on both compartments. Connect building wires to the same color power supply wires with wire nuts or UL certified electrical connector.
- Outdoor 24VDC class 2 output remote power supply must be installed away from any heat sources and it must be accessible for service.
- Outdoor 24VDC class 2 output remote power supply is UL listed.

## SYSTEM DIAGRAM:

### ON/OFF Switch System

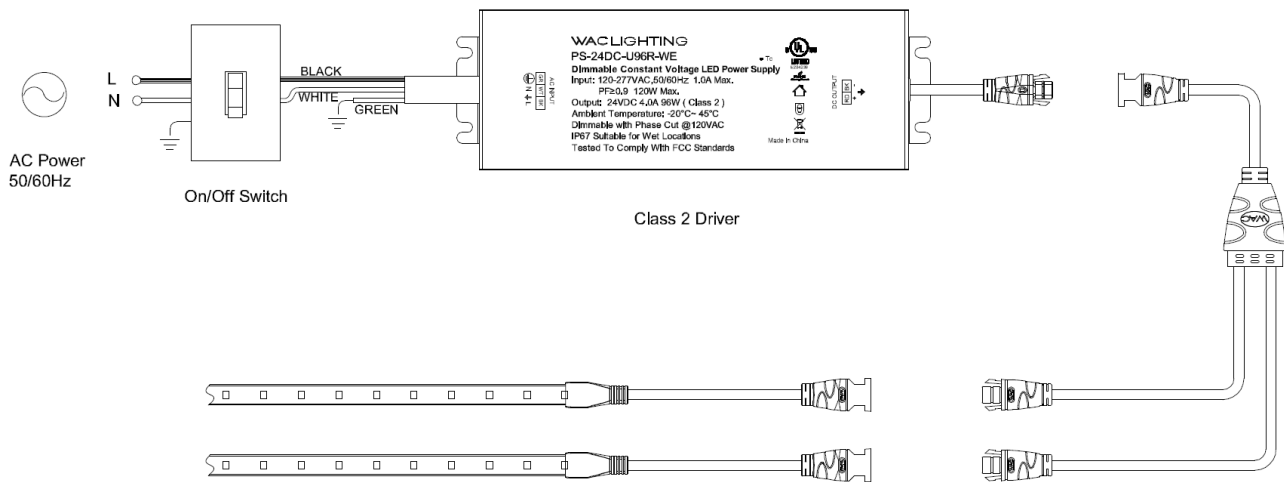

### TRIAC/MLV/ELV Dimmer Control System

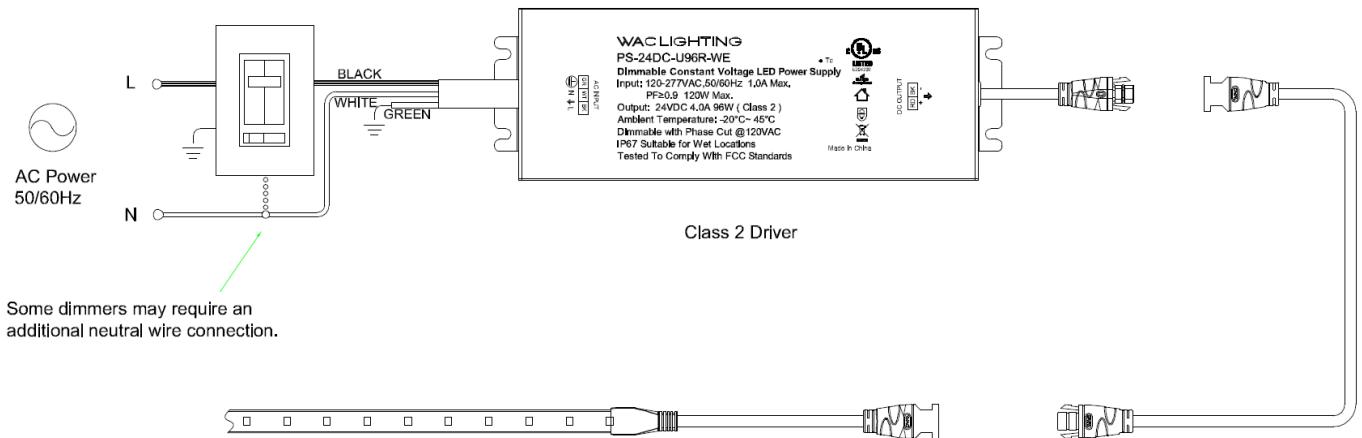

**CAUTION: InvisiLED Outdoor Tape light will not be able to dim with other brands power supply. Using only designed power supply to achieve best dimming result.**