



CAL LIGHTING

3625 E. Philadelphia St. Ontario CA. 91761 • Tel: 909.947.5200 • Fax:
909.947.5673 • www.calighting.com • service@calighting.com •
Specifications subject to change without notice

Type: _____

Project: _____

Catalog No.: _____

Lamp/Wattage: _____

Drawing:

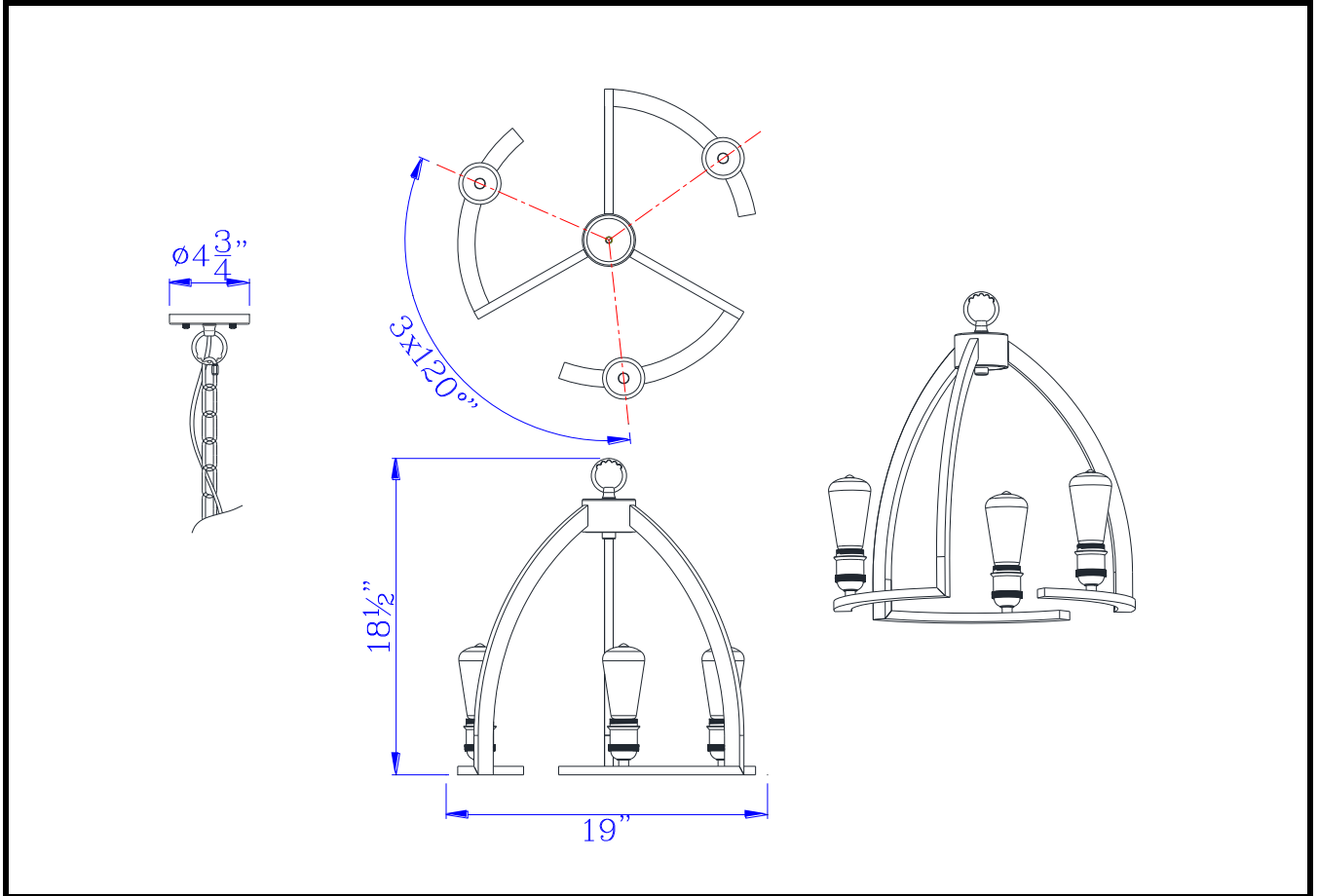

- Model No:** FX-3664-3
- Description:** 60W x 3 Kinder metal 3 light chandelier
- Material:** Metal/Wood
- Finish :** Dark Bronze
- Height:** 18 1/2"
- Width:** 19"
- Reach:** 19"
- Wattage :** 60W X 3
- Socket :** Medium Base (E26)
- Bulb:** Incandescent,CFL
- Chain Length:** 6'
- Wire Length:** 10'
- Wire Color:** Black
- Shade No:**
- Material:**
- Shade size:**
- Certificate :**

