

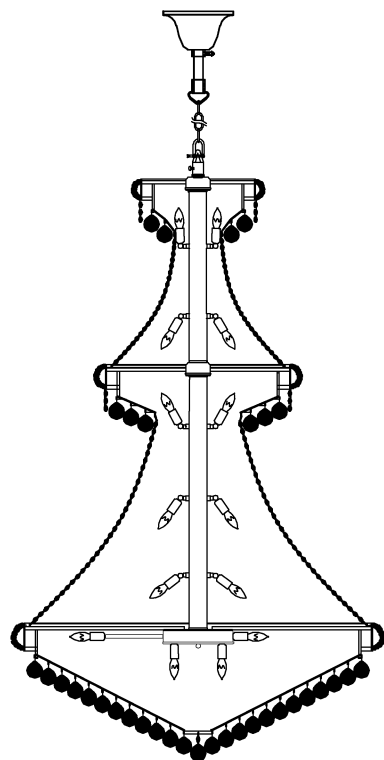

Trade Mark:  
CRYSTAL WORLD INC





Product Name: Pendant lamp  
Model :8001P42G  
120Vac, 60Hz,AC ONLY  
Lamp Size:Ø42"X72"H

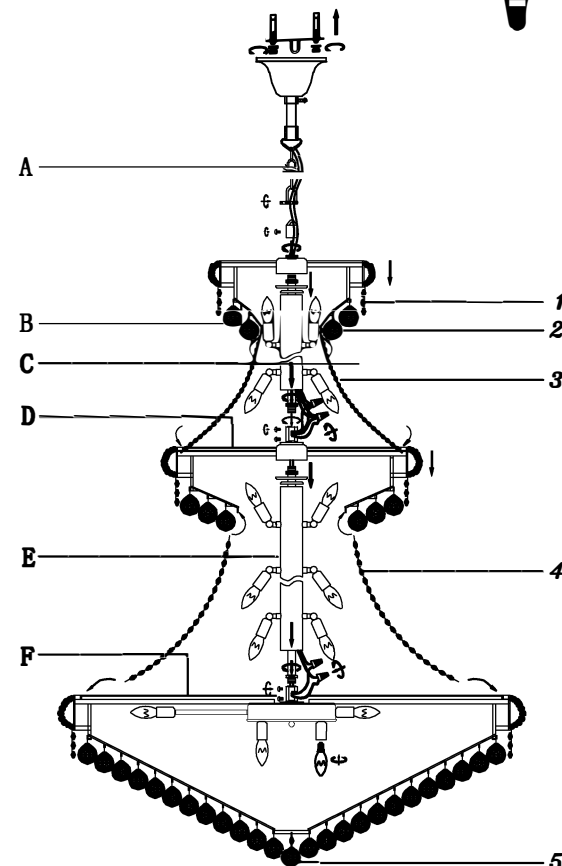

## PENDANT LAMP ASSEMBLY INSTRUCTIONS

1. Please fix (A) with (B).
2. Screw part (B) and (C) onto the part (D) secure with screw.
3. Screw part (D) and (E) onto the lamp body (F) secure with screw.
4. Please wear gloves when you hanging the crystal.
5. Install bulbs (NOT INCLUDED). USE 120V E12  38\*40W Max.



- |   |   |  |  |  |
|---|---|--|--|--|
| 1   | 2   | 3  | 4  | 5  |
|  14mm*3pcs |  40mm*1PCS |  14mm*24pcs |  14mm*33pcs |  14mm*1PCS<br>40mm*1PCS |
| 392sets   | 598sets   | 40sets   | 64sets   | 1sets  |

