

Installation Instructions

ITEM NO. : LA-8605-S LA-8605-M LA-8605-L

LA-8605-S: 13W Max LED
LA-8605-M: 26W Max LED
LA-8605-L: 39W Max LED

Remove all parts and hardware from the box along with any plastic protective packaging and carefully lay all the parts out on a clean, flat surface.

Recommended Location for use: Dry indoor environment.

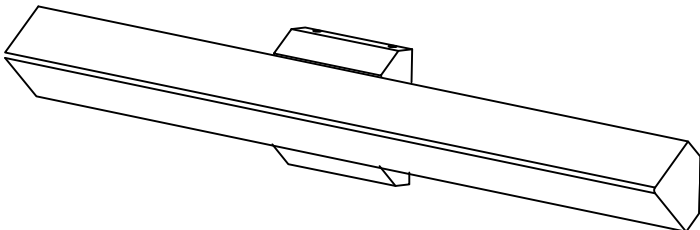
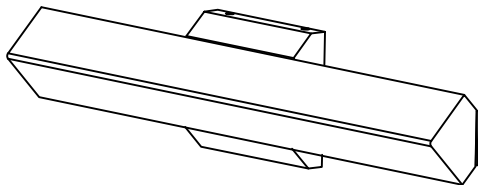
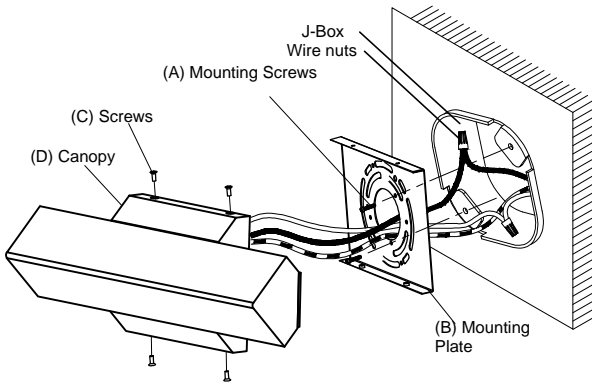

Installation

Shut off main power at circuit breaker before attempting to install luminaire.

1. Install mounting plate (B) to junction box using mounting screws (A).
2. Pull the existing electrical wires out of the junction box and make proper connections with this fixture using wire nuts.
3. Attach the canopy (D) to the mounting plate and secure it with 4 screws (C).

Turn on the main power and enjoy!

This LED light provides low maintenance service with no bulbs to change.

Suggested Dimmers

This fixture is designed to operate with most standard dimmer.

Noted below is a list of dimmers that have been tested with this fixture. This list of dimmers does not imply any guarantee or warranty of compatibility with a particular application.

Dimmers that are not listed do not imply non-compatibility.

DVCL-153P / SCL-153P / AYCL-153P / CTCL-153P / DVCL-253P / GT-150 / GTJ-250M (ALL ARE LUTRON BRAND)

WARNING

*** To ensure the success of the installation, be sure to read these instructions and review the diagrams thoroughly before beginning.

*** Installation must be performed by a qualified electrician.

Cleaning & Care:

To clean, wipe the fixture with a soft, dry cloth. Avoid the use of harsh or abrasive chemicals as they may damage the finish.

SAVE THESE INSTRUCTIONS FOR FUTURE REFERENCE.