

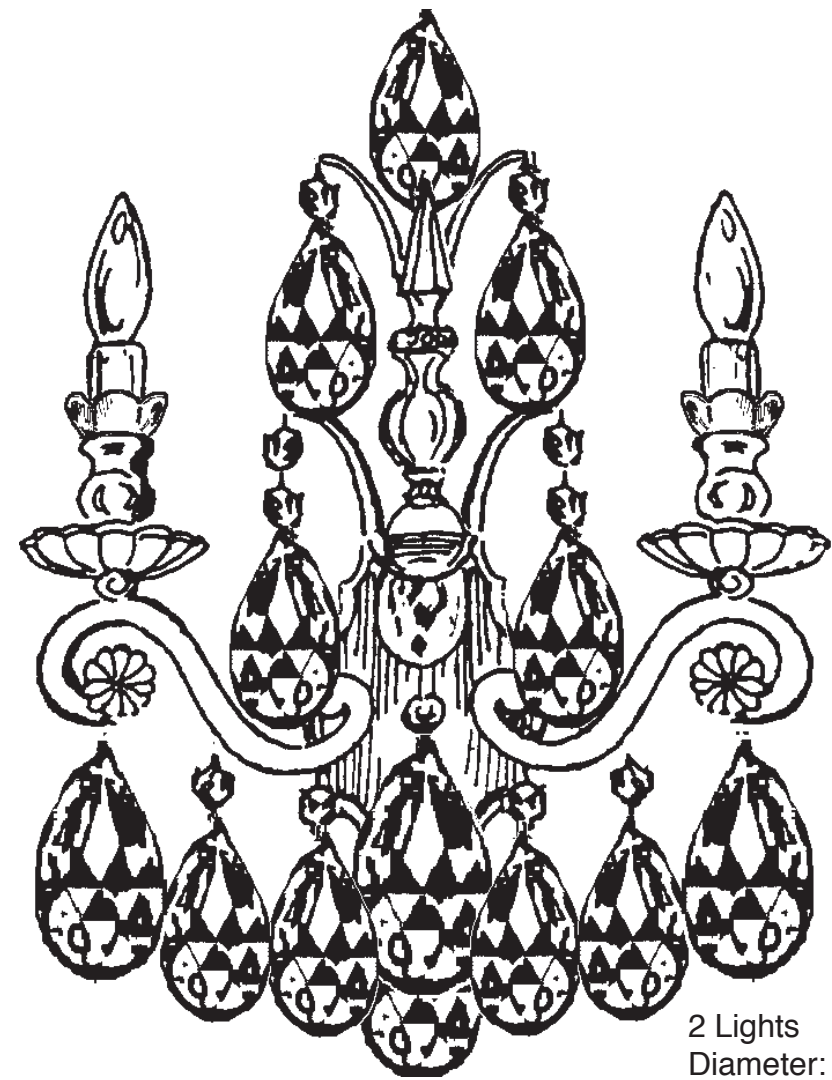

SCHONBEK®

RENAISSANCE 3761- __ __ TK



2 Lights
Diameter: 15"
Body Length: 22-1/2"
Extension: 8"
Hanging Weight: 8 lbs.

THIS DESIGN IS THE PROPRIETARY
TRADE DRESS/TRADEMARK OF
SWAROVSKI LIGHTING, LTD.



SCHONBEK®

MAX 60 W		110-120 V					

SCHONBEK® is a member of the Swarovski group.

All electrical components must be installed by a licensed electrician in accordance with the National Electric Code and the appropriate local electrical codes.

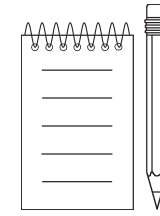
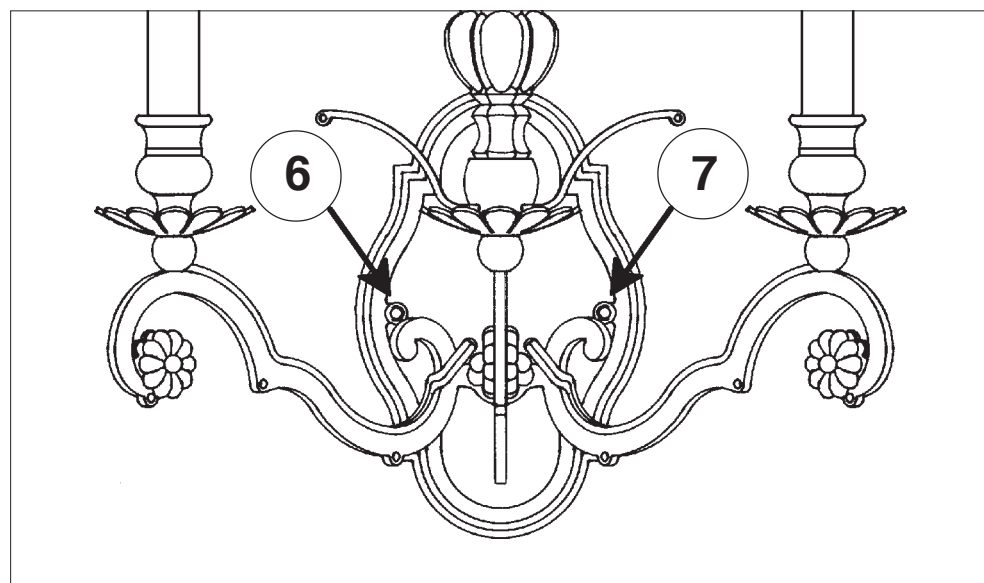
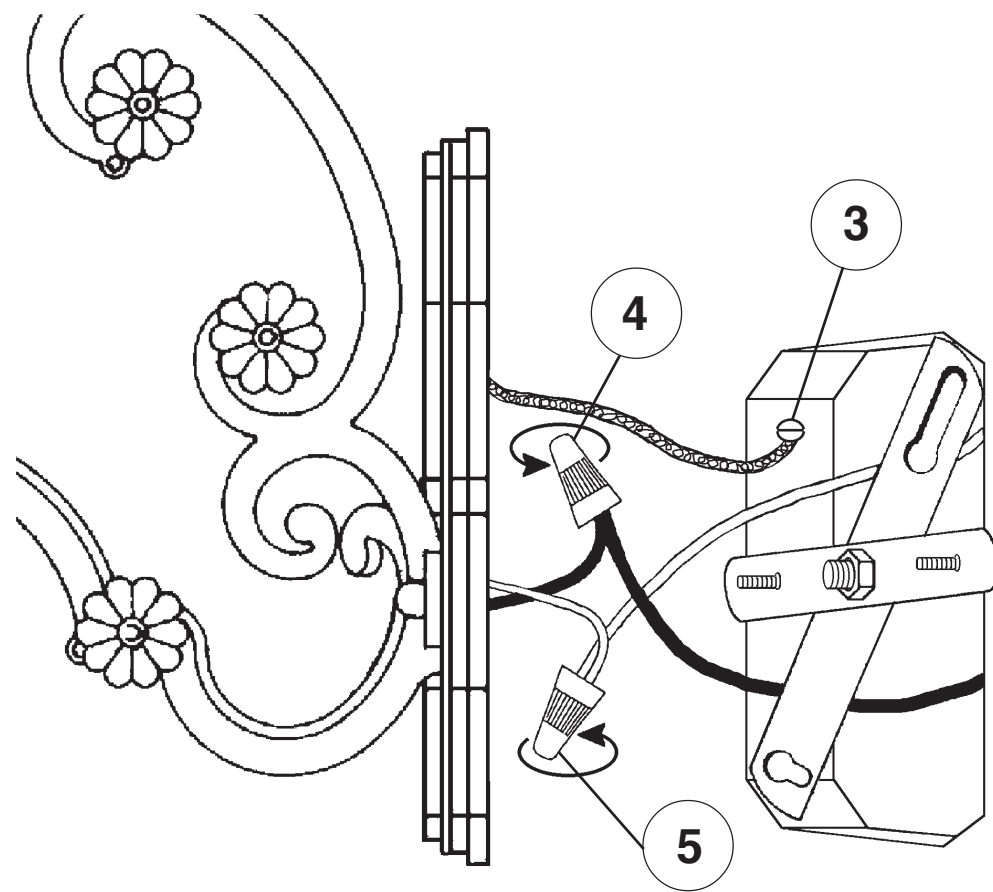
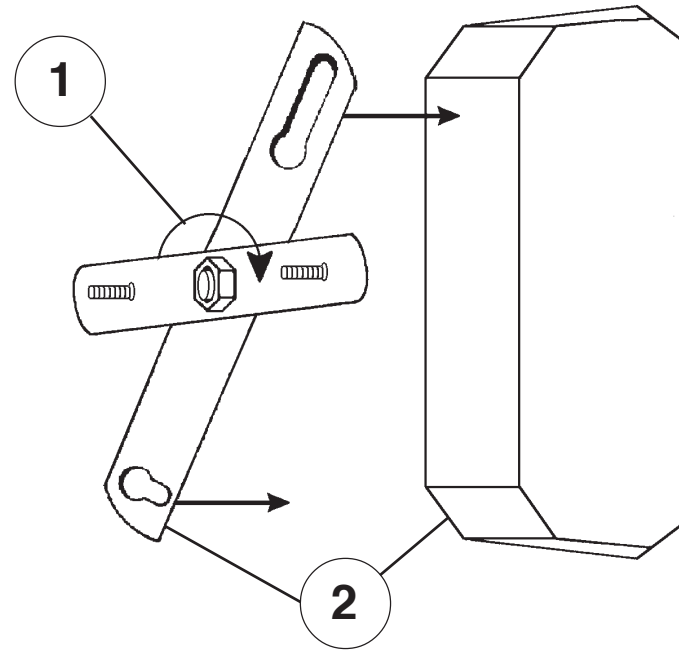

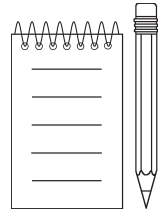

SET #1

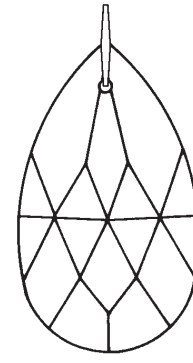

N2793TK
2"
50mm

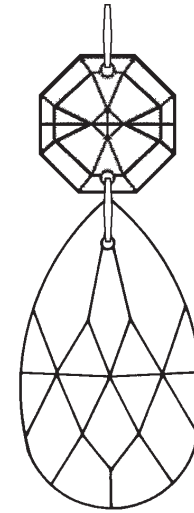

N4044TK
2"
50mm

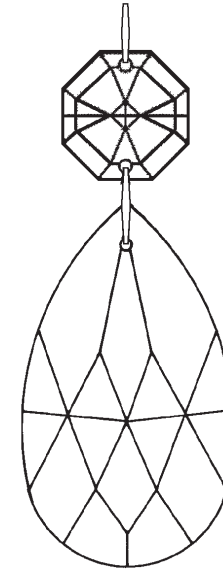

N4003TK
2-1/2"
63mm

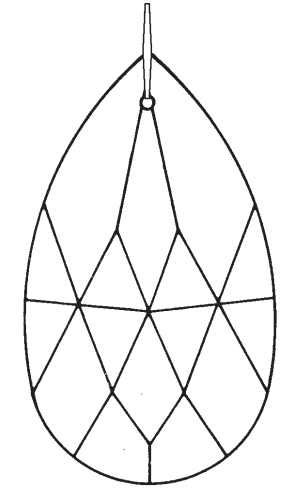

N4004TK
3"
76mm

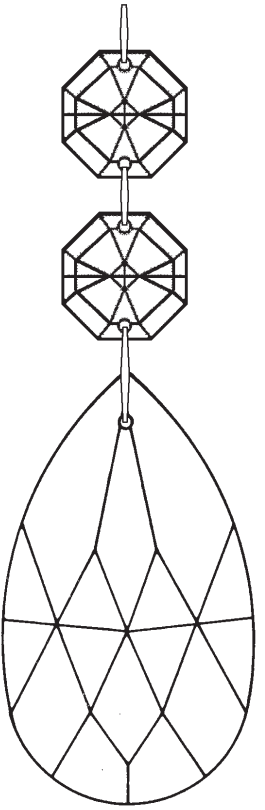

N4010TK
3"
76mm

SET #2

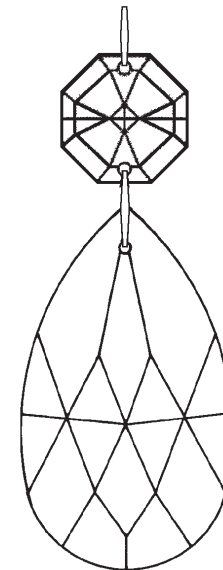

N4003TK
2-1/2"
63mm

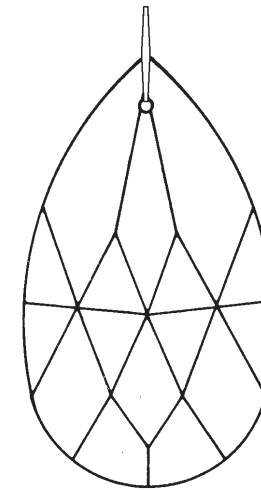

N4004TK
3"
76mm

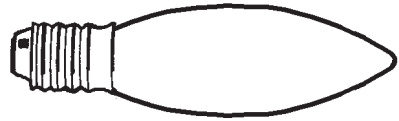

9 2 - B10
60 Watts Max
25 Watts Recommend

Crystal Set #1 in Black

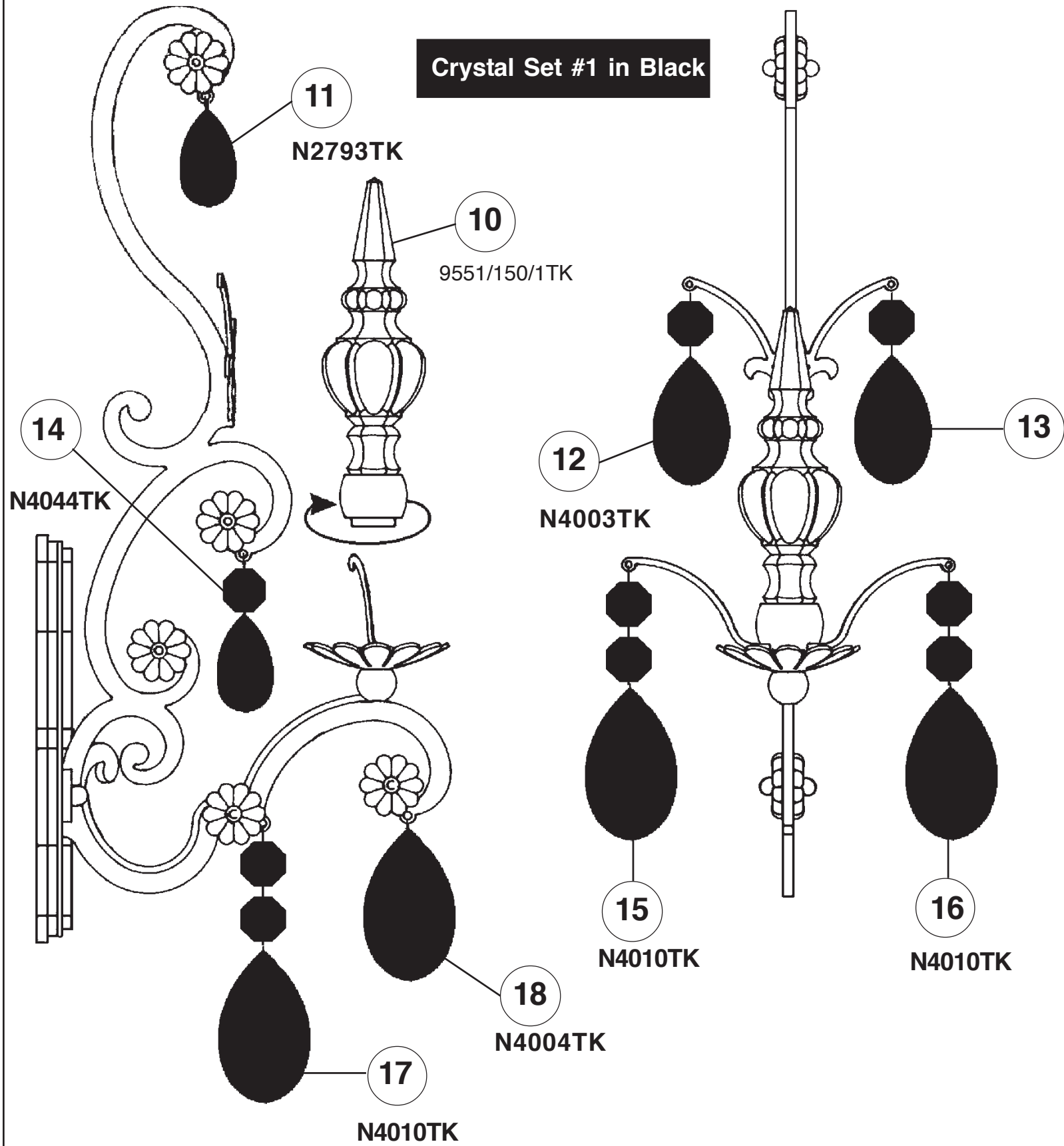

Crystal Set #2 in Black

