

# ASSEMBLY & INSTALLATION INSTRUCTIONS



Fixture  
BWSW32327

Fig. 2 Wiring

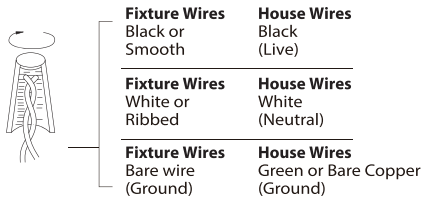

Fig. 3

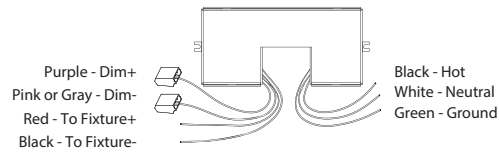

Fig. 4 Sealing

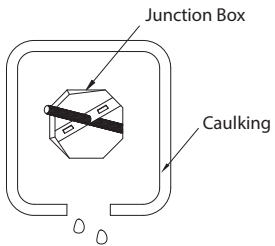
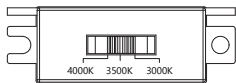
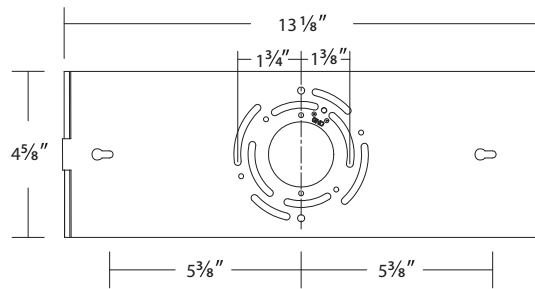

Fig. 5 Switch









MOUNTING BACK PLATE



Schonbek, 61 Industrial Blvd, Plattsburgh, New York, 12901  
 Phone: 1-800-836-1892 | Fax: 518-563-4228 |  
[www.schonbek.com](http://www.schonbek.com)

## HARDWARE

- |                                                                                     |                                                                                     |                                                                                     |                                                                                     |                                                                                     |                                                                                     |                                                                                      |
|-------------------------------------------------------------------------------------|-------------------------------------------------------------------------------------|-------------------------------------------------------------------------------------|-------------------------------------------------------------------------------------|-------------------------------------------------------------------------------------|-------------------------------------------------------------------------------------|--------------------------------------------------------------------------------------|
| <b>A</b>                                                                            | <b>B</b>                                                                            | <b>C</b>                                                                            | <b>D</b>                                                                            | <b>E</b>                                                                            | <b>F</b>                                                                            | <b>G</b>                                                                             |
|  |  |  |  |  |  |  |
| Wire Connector<br>Qty: 3pcs+1 Extra                                                 | Mounting Screw<br>Qty: 1 Extra                                                      | Rubber Gasket<br>Qty: 1 Extra                                                       | Anchor<br>Qty: 2 pcs+1 Extra                                                        | Wood Screw<br>Qty: 2 pcs+1 Extra                                                    | Back Plate Screw<br>Qty: 1 Extra                                                    | Spring Washer<br>Qty: 1 Extra                                                        |

## ASSEMBLY & INSTALLATION INSTRUCTIONS

Fixture  
BWSW32327

SCHONBEK  
*Beyond*

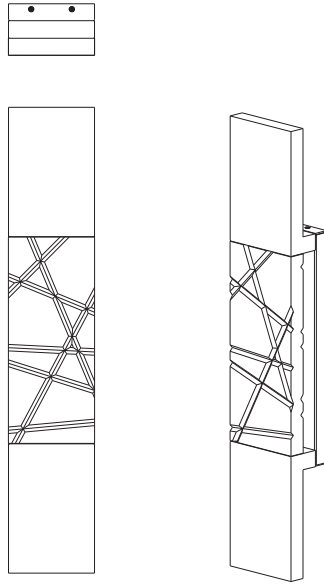

- WARNING**
- IMPORTANT: NEVER attempt any work without shutting off the electricity.
- Read all instructions before installing.
  - System is intended for installation in accordance with the National Electrical Code (NEC), other applicable installation code(s) and local regulations by a licensed electrician familiar with the operation of the product and the hazards involved.
  - Go to the main fuse box, or circuit breaker panel. Place the main power switch in the "OFF" position and unscrew the fuse (s) or switch "OFF" the circuit breaker switch (es) that control the power to the fixture (s) or room that you are working on.
  - Place the wall switch in the "OFF" position.
  - FAILURE TO INSTALL THIS FIXTURE IN ACCORDANCE WITH THESE INSTRUCTIONS MAY RESULT IN SERIOUS PERSONAL INJURY OR DEATH AND/OR PROPERTY DAMAGE.
- CAUTION**
- All parts must be used as indicated in these instructions. Do not substitute any parts, leave parts out, or use any parts that are worn out or broken. Failure to follow this instruction could invalidate the ETL/CETL Listing of this fixture.
  - When handling the fixture, do not apply pressure to the LEDs or bulbs. Hold the fixture by the base only.
  - Do not exceed maximum wattage noted on the fixture. Use only the recommended LED or standard lamps with the fixture.

- ADVERTENCIA**
- IMPORTANTE: NUNCA trate de hacer ningún trabajo sin desconectar la electricidad.
- Lea todas las instrucciones antes de instalar.
  - El sistema tiene por objeto la instalación de acuerdo con el Código Eléctrico Nacional, y otros códigos de instalación y reglamentos locales aplicables, por parte de un electricista autorizado que esté familiarizado con el funcionamiento del producto y los peligros involucrados.
  - Vaya a la caja de fusibles o al panel de disyuntores principal. Ponga el interruptor principal de alimentación en la posición de "APAGADO", y desenchufe los fusibles o "DESCONECTE" los disyuntores que controlen la alimentación a los dispositivos o la habitación en los que usted está trabajando.
  - Ponga el interruptor de pared en la posición de "APAGADO".
  - EL HECHO DE NO INSTALAR ESTE DISPOSITIVO DE ACUERDO CON ESTAS INSTRUCCIONES PODRÍA RESULTAR EN UNA LESIÓN PERSONAL GRAVE O LA MUERTE, Y/O DAÑOS A LA PROPIEDAD.

- PRECAUCIÓN**
- Todas las piezas deben usarse como se indica en estas instrucciones. No sustituya ninguna pieza, no deje piezas fuera, ni utilice ninguna pieza que esté desgastada ni rota. El hecho de no seguir estas instrucciones podría invalidar la certificación ETL/CETL de este dispositivo.
  - Al manipular el dispositivo, no aplique presión a los LED ni las bombillas. Sujete el dispositivo solo por la base.
  - No exceda la potencia máxima indicada en el dispositivo. Use solo los LED o las bombillas estándar recomendados con el dispositivo.

- ADVERTENCIA**
- IMPORTANT: NUNCA trate de hacer ningún trabajo sin desconectar la electricidad.
- IMPORTANT: Ne JAMAIS entreprendre des travaux sans couper l'électricité.
- Lire toutes les instructions avant l'installation.
  - Ce système est conçu pour être installé conformément au Code national de l'électricité ou d'autres codes d'installation et réglementations locales en vigueur par un électricien agréé connaissant le fonctionnement de ce produit et les dangers qu'il comporte.
  - Aller à la boîte à fusibles ou panneau principal de disjoncteurs. Placer l'interrupteur d'alimentation principal sur « ARRÊT » et dévisser le ou les fusibles ou mettre sur « ARRÊT » le ou les disjoncteurs qui contrôlent l'alimentation du ou des appareils électriques ou de la pièce dans laquelle vous travaillez.
  - Mettre l'interrupteur mural sur « ARRÊT ».
  - NÉGLIGER D'INSTALLER CET APPAREIL CONFORMÉMENT À CES INSTRUCTIONS RISQUE D'ENTRAÎNER DE GRAVES BLESSURES PERSONNELLES OU LA MORT AINSI QUE DES DOMMAGES MATÉRIELS.
  - MISE EN GARDE
  - Toutes les pièces doivent être utilisées comme indiqué dans ces instructions. Ne remplacer aucune pièce, ne laisser aucune pièce de côté ou n'utiliser aucune pièce usée ou cassée. Le non-respect de cette directive peut invalider l'homologation ETL/CETL de cet appareil.
  - Lors de la manipulation de cet appareil, n'appliquer aucune pression sur les DEL ou les ampoules. Maintenir l'appareil par la base uniquement.
  - Ne pas dépasser le nombre de watts maximum indiqué sur l'appareil. N'utiliser que les DEL ou ampoules standard recommandées dans cet appareil.

## ASSEMBLY & INSTALLATION INSTRUCTIONS

Fixture  
BWSW32327

SCHONBEK  
*Beyond*

Fig. 1

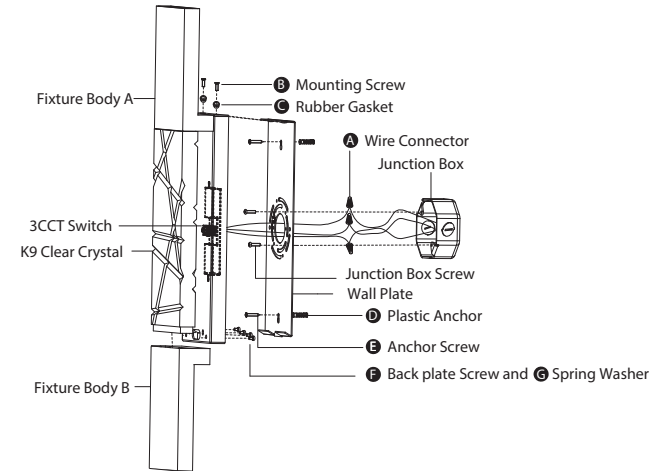

### PREPARATION

1. Shut off the power at the circuit breaker and remove existing fixture, including the crossbar.
2. Carefully unpack your new fixture and lay out all the parts on a clear area. Be careful not to lose any small parts necessary for installation.

### MOUNTING THE FIXTURE (Fig. 1)

3. Remove the mounting screw (B) and rubber gasket (C) from the wall plate.
4. Remove the two screws (F) and spring washers (G) on the back plate which is unglued side, loosen but do not remove the middle two screws.
5. Turn the fixture body B outward until you can put the crystal into the fixture body A and B. Secure the back plate screws and spring washers when the crystal is fasten between two fixture bodies.
6. The fixture can switch between three color temperatures (3000K-3500K-4000K), which can be adjusted to your preference with the switch in the back plate (Fig.5).
7. Drill holes in the wall aligned with the key holes located in the wall plate. Insert the plastic anchors (D).
8. First, secure the wall plate to the junction box using the original junction box screws. Second, fasten the wall plate to the wall using plastic anchor (D) and anchor screw (E).
  - (i) It is recommended to use only original junction box screws or replacements provided by junction box manufacturer.
  - (ii) The side of the wall plate marked "GND" must face out, towards the installer.

### CONNECTING THE WIRES (Fig. 2)

9. Connect the driver's input wires to the junction box (Fig. 2) using wire connectors (A) provided. Ensure all wire connectors are secure. Connect the fixture's ground wire to the ground in the junction box; this will be either a green wire or a bare copper wire. After fixture is wired to house wires, tuck wires carefully inside the junction box.

### DIMMING WIRING INFORMATION (Fig. 3)

10. This fixture features electronic low voltage (ELV or TRAC) or 0-10V dimming capabilities. See notes below for dimming wires information.
  - (i) To utilize ELV or TRAC dimming: use wires black (live), white (neutral) and house green wire or bare copper wire (ground). Do not use dimmer wires on driver for ELV or TRAC dimming.
  - (ii) To utilize 0-10V dimming: use wires purple (dim+), Pink or gray (dim-) from driver and connect to corresponding wires in junction box.

**NOTE:** Make sure to connect 0-10V prior to power-up the fixture in order to allow the 0-10V dimming to function properly.

### COMPLETING THE INSTALLATION

11. Secure the fixture to the wall plate using the mounting screw (B) and rubber gasket (C).
12. To prevent moisture from entering the outlet box and causing a short, use clear caulking (i.e. indoor/outdoor silicone sealant) to outline the outside of fixture back plate where it meets the wall. Leave a space at the bottom to allow moisture to escape Fig.4.

**MAINTENANCE NOTE:** Coastal conditions may cause mineral and residue build-up on the fixture. We recommend that customers in coastal areas clean all external surfaces of the fixture once every two weeks with a wet cloth.

本页仅用于版本控制，请勿印刷！

序号	变更说明	变更人	变更日期
1	更新型号 BWSW32227 为 BWSW32327	陈蜜	09/30/2022
2	折叠方式更改为短边对折一下	陈蜜	11/16/2022
3	更新附件包示意图、增加驱动示意图及调光步骤	陈蜜	12/05/2022
4			
5			



规格: 80 克进口书写纸 A4, 双面印刷, 短边对折一下  
审核: 陈俊 12/05/2022 标准化: 陈俊 12/05/2022

图号: BWSW32227-20 D  
批准: 张建中 12/05/2022