

Tools Required

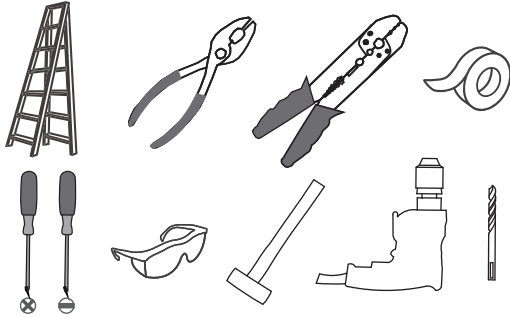

Light Source

27W
LED

⚠ Warnings and Cautions

Turn off the electricity at the circuit breaker before installation. Consult a licensed electrician if in doubt about installation.

Package Contents

Preparation: Identify and inspect all parts before beginning the installation.

Missing or damaged parts? Contact your original place of purchase.

PARTS BAG

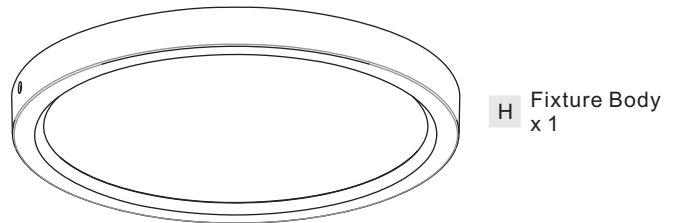
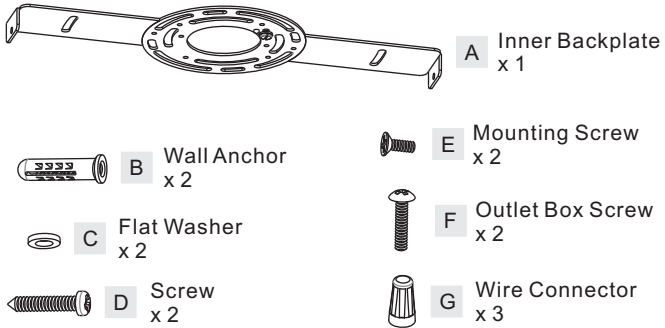

Table of Contents

Inner Backplate	Wiring	Fixture Body
STEP 1	STEP 2	STEP 3

STEP 1

1

Fit inner backplate to outlet box

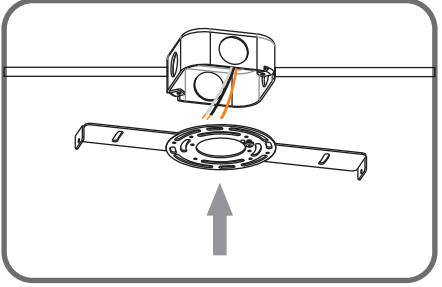

2

Mark anchor holes location on the ceiling

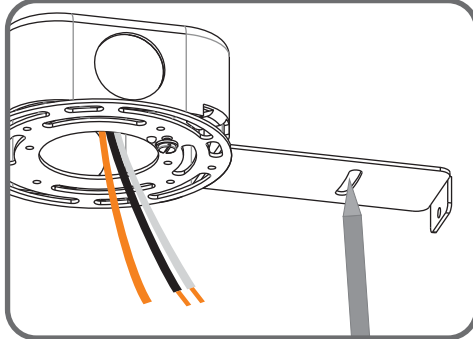

3

Drill holes for anchors from marks

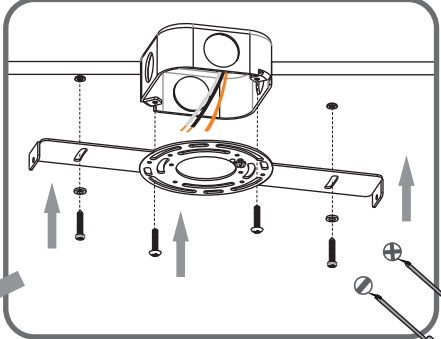
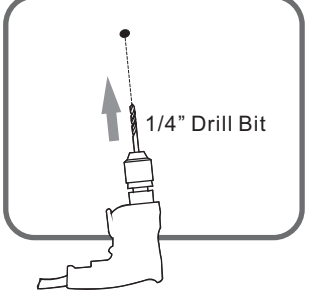

Install inner backplate

5

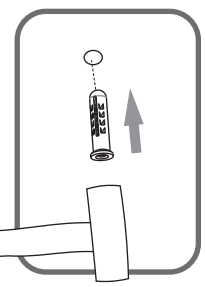

Install wall anchors

4

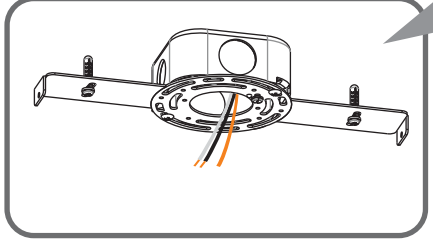

STEP 2

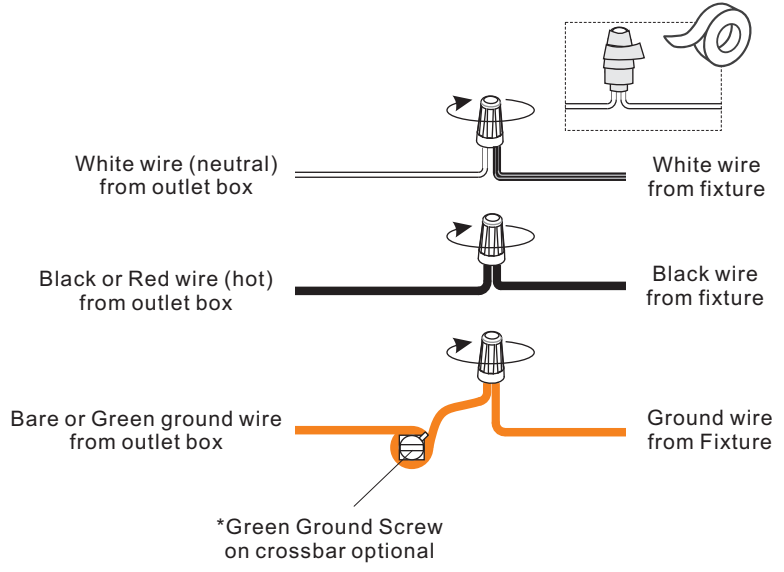

STEP 3

