

# LIVING DISTRICT

Installation manual for:

LD8801D60C,LD8801D60BK,LD8801D60GB

Dimensions: D59.1"H63"L24

Collection: Cordelia

Bulb Type : E12 bulb not included

Lamp Frame Weight (lbs) : 58.5

Total weight (lbs) : 73

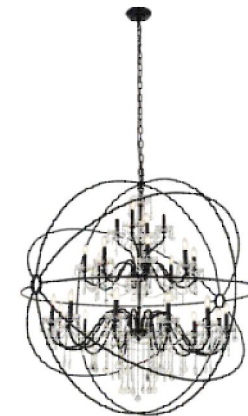

Thank you for choosing world famous brand chandelier. We are providing the finest quality crystal chandelier for our customers. Our master designers and craftsmen intend to give a professional insight on lighting design & product quality. Prompt and efficient services are our priority. We enclosed detail instructions on how to install your chandelier properly. Please read all instructions carefully & thoroughly. If you have any questions, our professional customer service team committed provided all the information of our products, please call our toll free

CHANDELIER HOTLINE AT:

**1-888-388-3390**

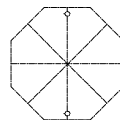

## SAFETY

**Warning: MAKE SURE THE ELECTRICITY TO THE WIRES YOU ARE WORKING ON IS SHUT OFF, BY EITHER REMOVING THE FUSE OR TURNING OFF THE CIRCUIT BREAKER.**

## CAUTION

- Before assembling the lighting fixture, please read all instructions carefully.
- All frame & crystal components are fragile, please handle with care.
- Required supply circuit : 110 - 130V/60Hz
- Labeled wires are "L" for live wire, "N" for neutral wire, "E" for ground wire.
- Never install fixture on damp ceiling, the room should be dry and well ventilated
- All electrical components must be installed by a licensed electrician and in accordance with the National Electrical Code and the appropriate local electrical codes.

## Unpack the Package

Please open the box carefully and check all the items are inside the box. If you have any installation, assembling and missing parts questions, please call our Customer Service department at 1-888-388-3390. Please have model number (at the front page), where you purchase from and any other relevant information ready, our customer service team will provide comprehensive and worry free service to our valued customers.

01

## Frame Parts List

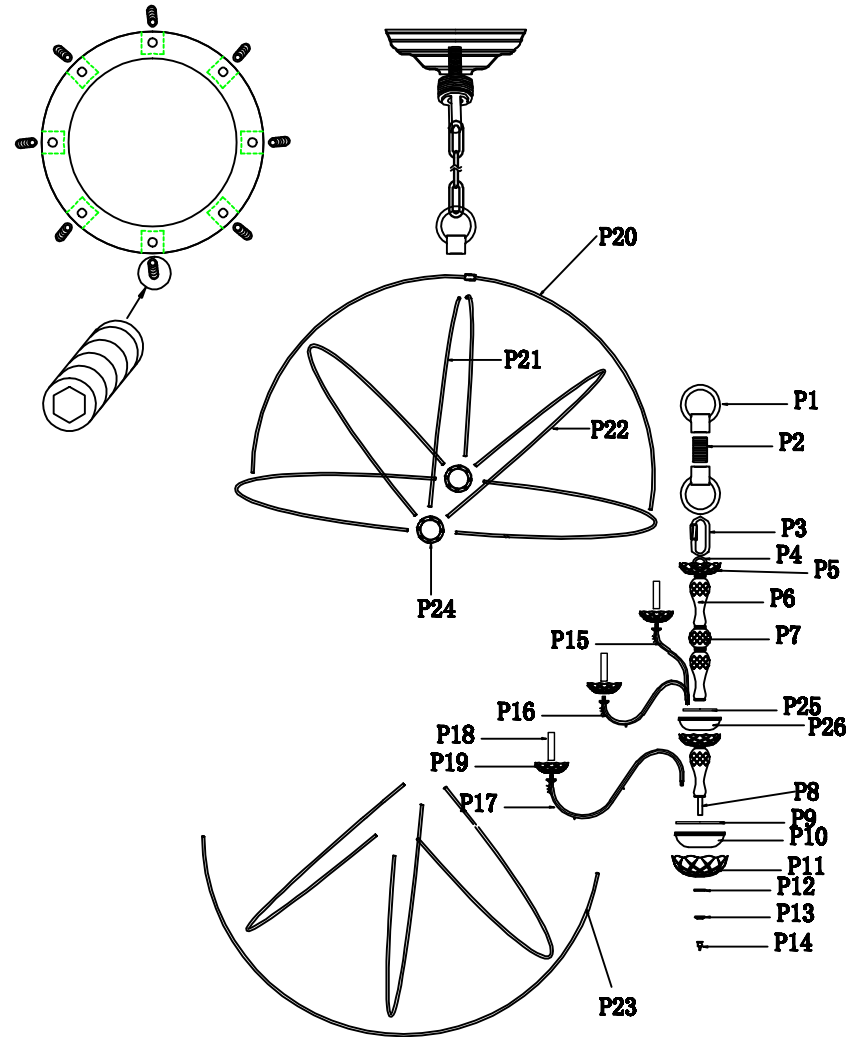

02











LD8801D60 D59.1"H63"L24

### Step 1

Please use the parts list to ensure you are not missing any parts













LD8801D60

#### PARTS LIST

part	picture	Description	Parts Number	Qty	Check list
ZA		ø5.9" Canopy	CP80R59L3C CP80R59L3BK	1	
ZB		4.1" Crossbar		1	
ZC		Canopy ring		1	
ZD		loop		1	
ZE		L59" Chain05P Plain Design	CHAIN05PCH	1	
ZF		Power Cord 79" SPT-1-18# Clear/Brown		1	
P1		ø1.6" Crystal eyelet		2	
P2		ø0.5" * L1.6" nipple			
P3		Cover		1	
P4		ø2.0" Crystal eyelet		1	









03

LD8801D60 D59.1"H63"L24

part	picture	Description	Parts Number	Qty	Check list
P5		ø5.9" Glass dish	GD8002B59CL	2	
P6		H7.1" Glass column	MC8005E71CL	3	
P7		ø2.8" Glass ball	MC8005E28CL	1	
P8		ø0.6" * ø5.1" water pipe		1	
P25		ø6.1" Round metal plate		1	
P26		ø5.2" Metal cover		1	
P9		ø7.1" Round metal plate		1	
P10		ø7.2" Metal cover		1	
P11		ø7.9" Glass dish	GD8002A79CL	1	
P12		ø1.2" Small plate		1	
P13		ø1.4" Small plate			
P14		Bottom lock		1	
P15		ø0.4" * 13.6" Metal S-shape Arm		4	













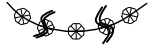

04

LD8801D60 D59. 1"H63"L24

part	picture	Description	Parts Number	Qty	Check list
P16		∅0.4"*19.9" Metal S-shape Arm	/	8	
P17		∅0.4"*30.9 Metal S-shape Arm	/	12	
P18		∅0.9"*H4.1" Metal tube	/	24	
P19		∅4.7"Glass dish	GD8002G47CL	24	
P20		∅0.4"*L42.9" Arm-2pcs +∅1.6"Lamp body	/	1	
P21		∅0.4"*L44.1" Arm	/	2	
P22		∅0.4"*L88.6" Arm	/	7	
P123		∅0.4"*L97"Arm	/	1	
P24		∅3.9"*H0.6" Lamp body	/	2	

05

LD8801D60 D59. 1"H63"L24

part	picture	Description	Parts Number	Qty	Check list
A		1050-14##*3+ 911-2"	/	4	
B		1050-14##*1+ 911-2.5"	/	4	
C		1050-14##*11	/	4	
D		1050-14##*3+ 911-2"	/	5	
E		1050-14##*1+ 911-2.5"	/	8	
F		1050-14##*1+ 911-2.5"	/	8	
G		1050-14##*14	/	8	
H		1050-14##*1+ 911-2"	/	120	
I		1050-14##*14	/	12	
J		1050-14##*2 +911-2.5"	/	12	
K		1050-14##*1+ 911-2.5"	/	12	
L		1050-14##*9+ 911-2.5"	/	12	
M		1050-14##*17+ 911-2.5"	/	12	
N		1050-14##*16+ 911-2.5"	/	6	
O		1050-14##*16+ 701-40#	/	1	

06

## Step 2

## Canopy Installation Instruction

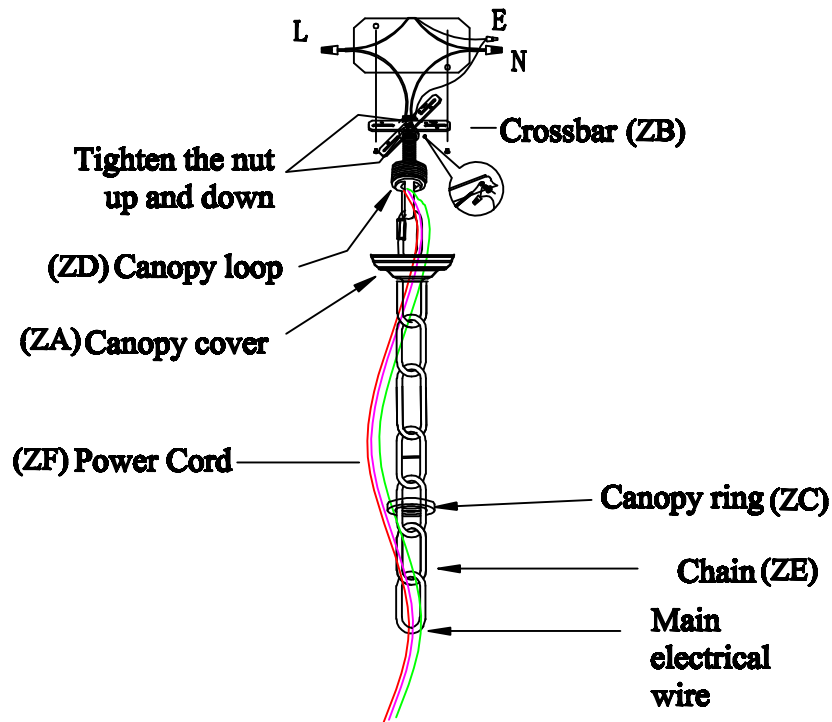

"L" = Hot wite  
 "N" = Neutral wite  
 "E" = Ground wite

07

**IMPORTANT:** Test sockets with bulb before dressing the fixture.

- 1 .Drill a  $\phi 0.7$ " hole in the ceiling reinforcement to allow a  $1\frac{1}{16}$ " threaded rod to pass through.
- 2 .Attach the electrical box to the ceiling reinforcement and pass the  $1\frac{1}{16}$  threaded rod through the box and secure it to the heavy duty hickey.
- 3 .Pass the fixture wires and ground wire through the loop, canopy ring, center hole of canopy and the heavy duty hickey.
- 4 .Pull ceiling wires down through the fixture box and make connection.
- 5 .Screw loop only onto threaded pipe.
- 6 .Hang the fixture on chain.
- 7 .Secure the canopy with canopy ring.

08

## Frame Assembly Diagram

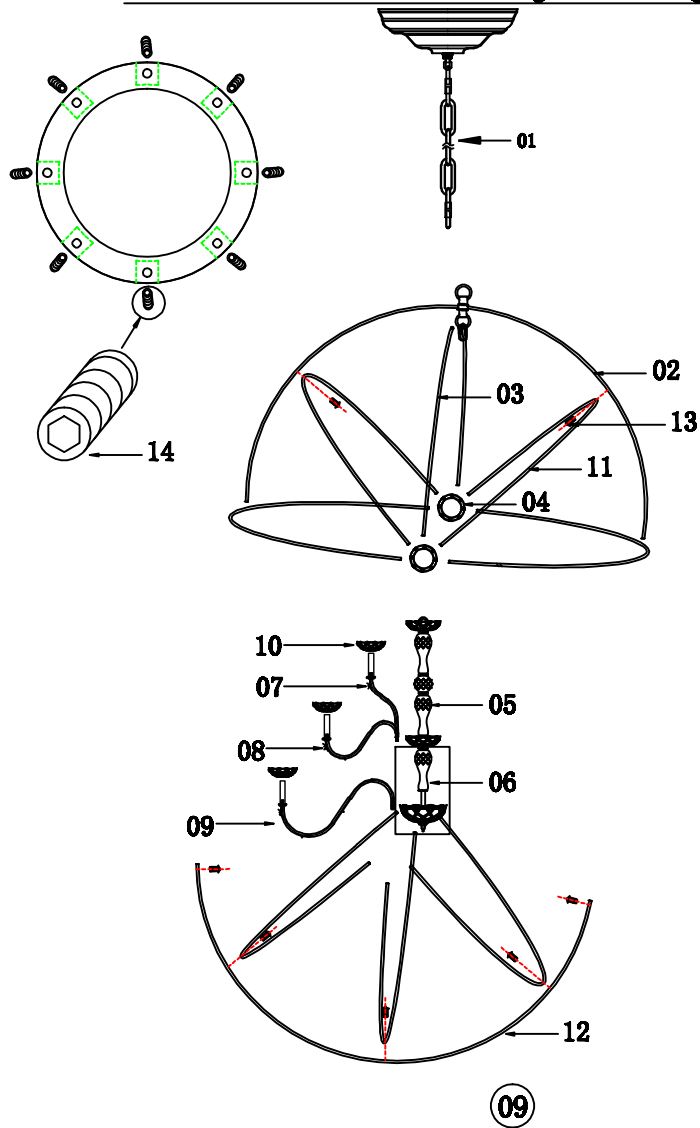

## Step 3

## Frame Assembly Instructions

### Installation:

Please read all instructions carefully.

Before you proceed to install, make sure that the power supply is turned off and remains off until installation is complete.

Please note that each part has been assigned a number.

Please proceed in a numerical order.

1. Hang the chain(01) on the ceiling.
2. Hang the lamp body(02) on the chain(01).
3. Install metal arm(03) on the lamp body(02) with Screw(14).
4. Install lamp body(04) on the metal arm(03) with Screw(14).
5. Hang the main body(05) on the lamp body(02), pass the main line through the lamp body(02), and correctly connect the wires .
6. Break up the main body(05) and assemble the metal arm(07) (08), and correctly connect the wires.
7. Connecting the main body(06) with the main body(05).
8. Break up the main body(06) and assemble the metal arm(09), then correctly connect the wires.
9. Put the glass dish(10) on the metal arm.
10. Install the metal arm (11) to lamp body(04) with Screws(13).
11. Connect metal arm(12) and lamp body(02) with Screws(13).
12. The metal arm(11) is fixed to the lamp body(02) and metal arm(12) with Screws(13).

The end!

# Crystal Dressing Diagram



When dressing the chandelier with the crystals please remember to wear either rubber or cotton gloves. So as to prevent any damage or smudging on the crystals.

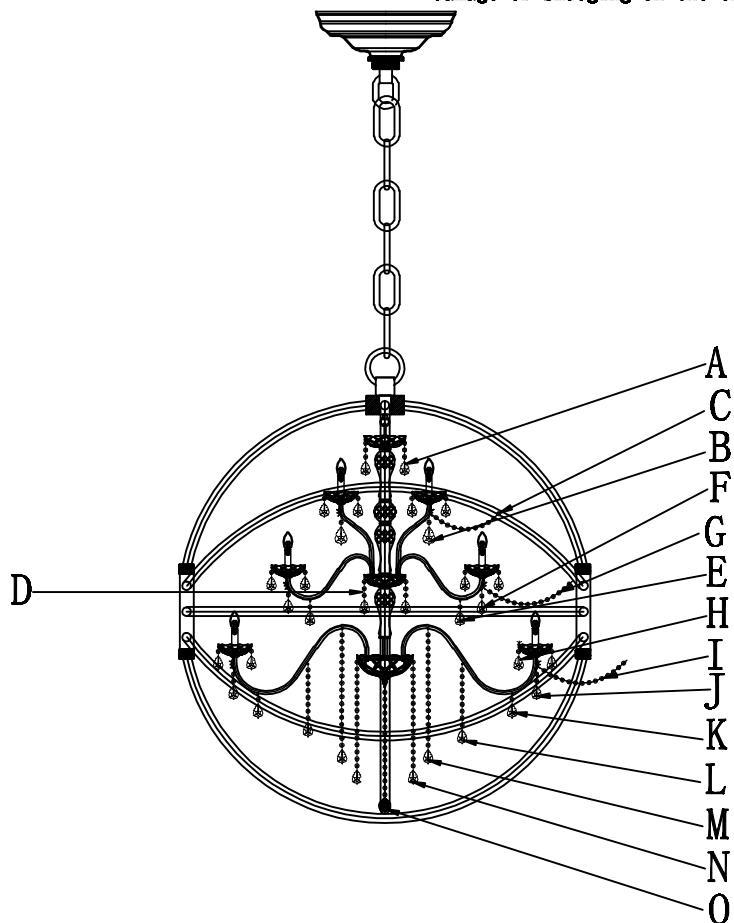

## Step 4

# Crystal Dressing Diagram

1. Hang crystal "A", "B", "C", "D", "E", "F", "G", "H", "I", "J", "K", "L", "M", "N", "O".

## Congratulations !

You are now done installing your Elegant Lighting fixture. Sit back and admire each crystal as it will become the statement piece for your room/house.

If you require any additional assistance, please contact us at 1-888-388-3390.

Thank you.

### Cleaning and Maintenance of Chandelier Frame

The finish on our chandelier frames and fixture frames is protected by a durable coating of lacquer. To clean, use a clean, soft, dry cloth. Do not use any metal polishes, cleaners, abrasives or any substance which could remove the protective finish. Failure to follow these instructions automatically voids the guarantee.

### Cleaning and Maintenance of Crystals

Wet a soft cotton fabric in clean warm water and wipe gently, then polish with a dry soft cotton fabric.

### To Order Crystal Replacement Parts

Should you require replacement crystals or pins (the metal connectors attaching the crystals), contact the store where the product was purchased or contact us at the address shown on the reverse side. For ease of ordering, you may use the original crystal trimming instructions provided with this product and circle the items you wish to order, indicating the quantity by writing the number needed adjacent to the circle and faxing it to our customer service department at 215-423-8882. You will be contacted with prices prior to shipment. All orders must be pre-paid.



### Elegant Lighting Warranty

The finish and frame of your new chandelier or fixture are warranted for a period of two(2)years from the date of purchase. Our company will at its option, repair or replace any frame that has a defect in the material or workmanship during the warranty period. All crystals are guaranteed for their original quality during the life of the chandelier. Breakage is not covered by this warranty.

To make a claim under this warranty, contact our customer service department at the address and phone number shown below. A written return authorization form will be sent to you with specific instructions.

**CUSTOMER SERVICE DEPARTMENT**  
500-550 E. Erie Avenue  
Philadelphia, PA 19134  
Tel: 215-423-8880  
Fax: 215-423-8882

### Returns and Conditions of Warranty

Returns must be pre-authorized by contacting our customer service department at the address on the reverse side. Returns will only be accepted with a written return merchandise authorization and return shipping charges pre-paid. We reserve the right to inspect all returned merchandise to fully determine the nature of any defect. This guarantee shall not apply to any product that has been changed, altered or otherwise modified, nor shall it apply to any product that has been repaired or altered by anyone other than a pre-authorized facility. We will not be responsible for any breakage or damages incurred during transit, nor for crystal parts or metal frame part that have been subject to misuse, negligence, accident or inappropriate handling. Also, we will not be held responsible for damage incurred during improper installation or wiring by others, nor for damages resulting from a failure to follow the recommended maintenance or installation procedures. This guarantee is issued in lieu of any and all other guaranteed or warranty, whether written or implied and any and all other obligations or liabilities.

Further, we neither authorize nor permit any other person or firm to assume for us, any liability in connection with the sale of our products.