

## IN41403

# INSTALLATION INSTRUCTIONS

Please read carefully and save these instructions, as you may need them at a later date.

### CAUTION

**WARNING:** Risk of Fire. Consult a qualified electrician to ensure correct branch circuit conductor. Min 90°C supply conductors.

Turn off the main power at the circuit breaker before installing the fixture, in order to prevent possible shock.

### GENERAL

All electrical connections must be in accordance with local and National Electrical Code (N.E.C.) standards. If you are unfamiliar with proper electrical wiring connections obtain the services of a qualified electrician.

Remove the fixture and the mounting package from the box and make sure that no parts are missing by referencing the illustrations on the installation instructions.

### ASSEMBLY AND INSTALLATION

1. Thread two machine screws (6) to the mounting plate (7) and secure with the hex nut (9).
2. Secure the mounting plate (7) with mounting screw (10) to the outlet box (1).
3. Pull out the outlet wire and ground wire from the outlet box (1). Make wire connections.  
--Ribbed wire (w/o marking) from light to White wire (2) from power source.  
--Smooth wire (w/o marking) from light to Black wire (4) from power source.  
--Loop the ground wire (3) to mounting plate (7) with a ground screw (8).
4. Attach the back plate (11) against the outlet box (1), secure with the ball nut (12).
5. Place the glass shade (14) over the socket (13) and secure with the socket ring (15).
6. Install bulbs: (bulbs not included)  
(Do not exceed the maximum capacity recommended on the sockets).

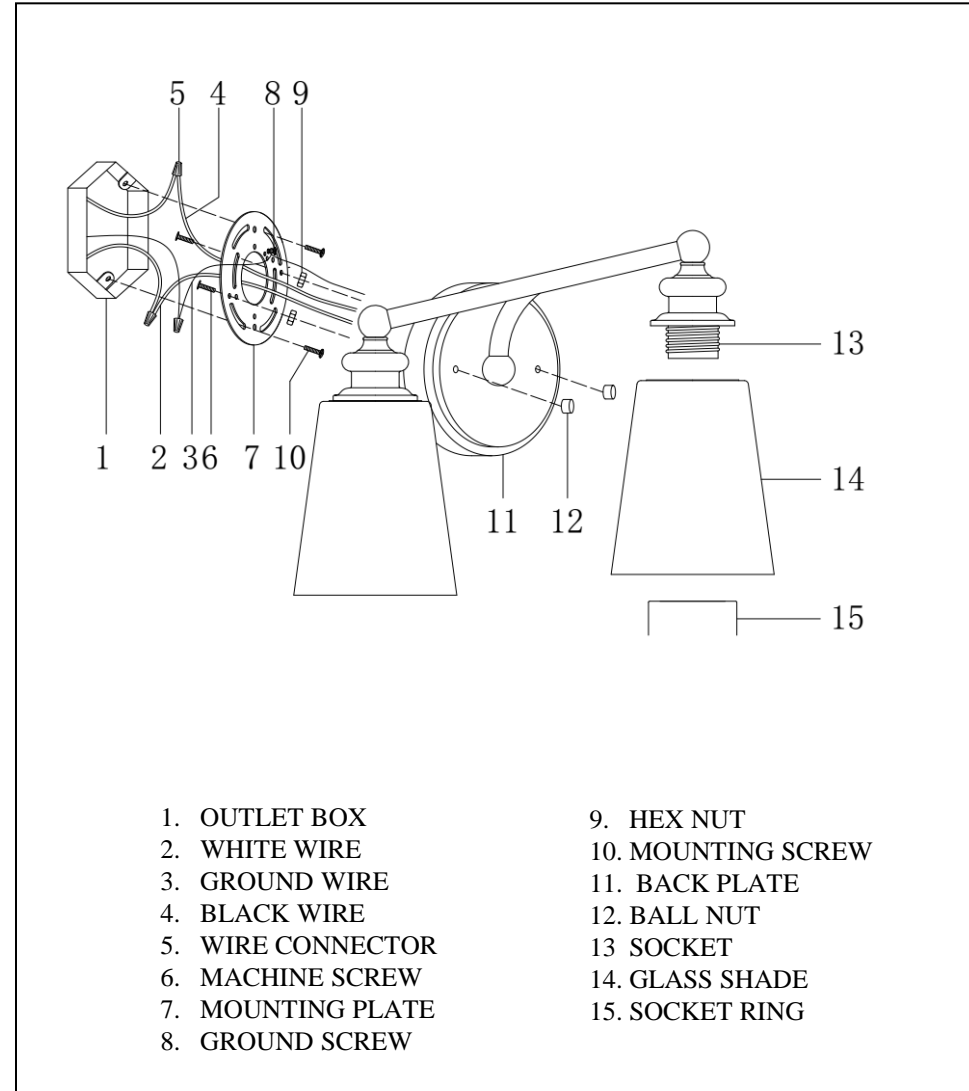

**INSTALLATION IS NOW COMPLETE**