

INSTALLATION INSTRUCTIONS

Interbeam Accent

5311

WAC LIGHTING

WARNING

IMPORTANT: NEVER attempt to do any work without shutting off the electricity.

1. Read all instructions before installing.
2. System is intended for installation by a qualified electrician in accordance with the National Electrical Code and local regulations.
3. Place the wall switch in the "OFF" position.
4. Go to the main fuse box, or circuit breaker. Unscrew the fuse(s) or switch "OFF" the circuit breaker switch(es) that control the power to the space that you are working on.
5. Risk of electric shock. Install all luminaires 10 feet (3.05m) or more from a pool, spa or fountain.

CAUTION

- All parts must be used as indicated in these instructions. Do not substitute any parts, leave parts out, or use any parts that are worn out or broken. Failure to follow this instruction may invalidate the UL listing of this fixture.

AVERTISSEMENT

IMPORTANT : Coupez l'électricité avant TOUTE manipulation.

- Lisez toutes les instructions avant d'installer.
- Système est destiné à être installé par un électricien qualifié en conformité avec le code national de l'électricité et les règlements locaux.
- Placez l'interrupteur mural en position d'arrêt (« OFF »).
- Toujours mettre le fusible ou le disjoncteur en position arrêt dans la pièce ou des travaux électriques sont prévus

MISE EN GARDE

- Toutes les pièces doivent être utilisées tel qu'il est indiqué dans ces instructions. Ne remplacez pas les pièces, n'en laissez pas de côté et ne les utilisez pas si elles sont usées ou brisées. Le non-respect de ces instructions peut annuler l'homologation UL du luminaire.

ADVERTENCIA

IMPORTANTE: NUNCA intente hacer trabajos sin desconectar el suministro eléctrico.

- Lea y comprenda todas las instrucciones e ilustraciones por completo antes de proceder con el ensamblaje e instalación de esta lámpara.
- Sistema está diseñado para ser instalado por un electricista calificado, de acuerdo con el código eléctrico nacional y las normas locales.
- Coloque el interruptor de la pared en la posición "OFF" (APAGADO).
- Diríjase a la caja de fusibles o a la caja del interruptor de circuito principal en su hogar. Coloque el interruptor de alimentación principal en la posición "OFF" (APAGADO).

PRECAUCIÓN

- Todas las piezas deben usarse como lo indican estas instrucciones. No reemplace las piezas, noomita piezas durante la instalación ni utilice piezas gastadas o rotas. El incumplimiento de esta indicación podría invalidar la calificación UL esta lámpara.

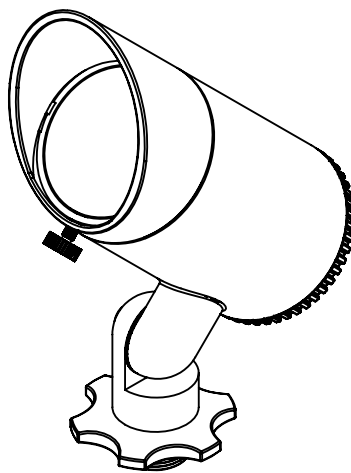

5311

waclighting.com
Phone (800) 526.2588
Fax (800) 526.2585

Headquarters/Eastern Distribution Center
44 Harbor Park Drive
Port Washington, NY 11050

Central Distribution Center
1600 Distribution Ct
Lithia Springs, GA 30122

Western Distribution Center
1750 Archibald Avenue
Ontario, CA 91760

INSTALLATION INSTRUCTIONS

Interbeam Accent

5311

WAC LIGHTING

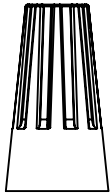

Wire Nut
Qty: 2 pcs
7EAC112201P3

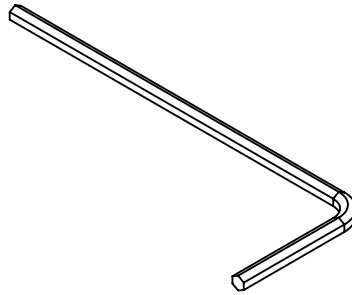

Hex Key
Qty: 1 pcs
7MPE155003

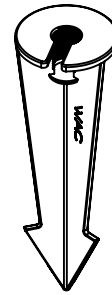

Mounting Stake
Qty: 1 pcs
9000-ST9-BZ

STEP 1: DETERMINING THE LOCATION

1. Make sure your main power is off.
2. At the point of installation, mount the stake by placing a piece of wood on the stake and hammering the wood. Hammer till the bottom of the ring is flush with the ground. Mounting Stake
Fixture Wire
Wire Slot
Light Fixture.
3. In the case of hard soil, dig a hole and place the stake in so that the bottom of the ring is flush with the ground. Fill the rest of the hole with the removed soil and pack it tight to secure the stake.
4. Screw the fixture onto the stake provided, leading the wire from the fixture through the wire slot in the stake.

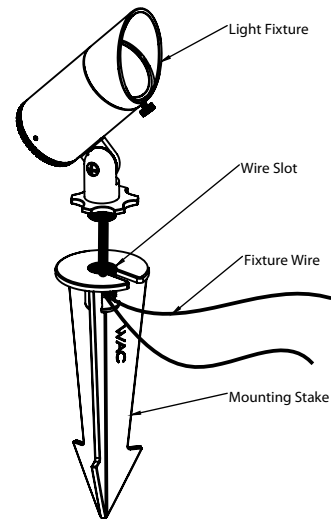

STEP 2: WIRING THE FIXTURE

***Note:** Transformer is required to power the fixture. (Sold Separately)

5. Cut the power supply wire from the transformer at the location of the fixture.
6. Separate the power supply wire into two individual wires by lightly pulling on each side so that a couple inches are separated.
7. Strip off 1/2 inch of the insulating material from each wire and connect one to each of the wires from the fixture using the outdoor rated direct burial wire nuts provided.

Note:

To install multiple fixtures, also connect the power supply wire of each additional fixture to the connection described in 7 of the previous fixture.

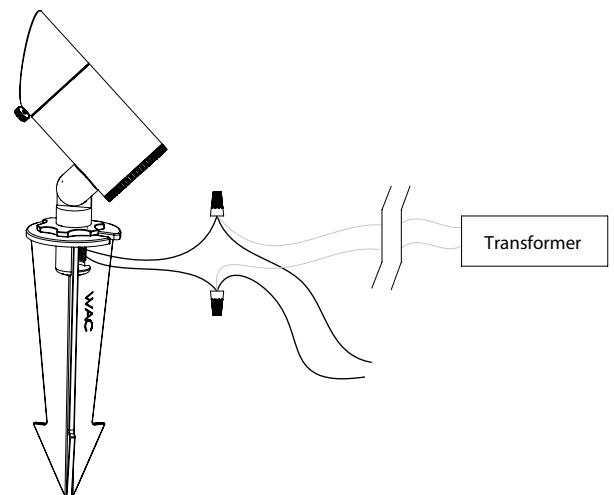

waclighting.com
Phone (800) 526.2588
Fax (800) 526.2585

Headquarters/Eastern Distribution Center
44 Harbor Park Drive
Port Washington, NY 11050

Central Distribution Center
1600 Distribution Ct
Lithia Springs, GA 30122

Western Distribution Center
1750 Archibald Avenue
Ontario, CA 91760

INSTALLATION INSTRUCTIONS

Interbeam Accent

5311

WAC LIGHTING

STEP 3: INSTALLING THE FIXTURE

8. Screw the fixture onto the stake provided, leading the wire from the fixture through the wire slot in the stake.
9. If desired, bury your wire by digging a small trench. Close the trench by applying an inward force to both sides of the trench.
10. Repeat steps for other fixtures in the same electrical circuit.
11. Turn the main power supply back on and make sure the fixtures light up.

Note: To install multiple fixtures, follow the diagram above.

STEP 4: AIMING THE FIXTURE

1. Tilting: Loosen the joint screw and adjust the head of the fixture to the desired direction before retightening the screw.
2. Loosen the mounting knob and rotate the fixture
3. to the desired position before retightening the knob.

STEP 5: BEAM ANGLE ADJUSTMENT:

1. Note the three pre-determined beam angles on the beam angle changing dial.
2. Use the provided Hex Key to slightly loosen the set screw one or two turns. Do not remove set screw from the fixture.

CAUTION: Do not remove set screw from the fixture. It should only be removed from the fixture for servicing. Consult factory for service instruction.

3. Hold the fixture body and rotate the dial until the Set screw is aligned with the desired beam angle. This beam angle may be one of the pre-determined markings or any number in between.

CAUTION: Keep the arrow marking on the fixture body between the beam angle range.

5. Tighten the set screw until it stops. Do not over tighten.

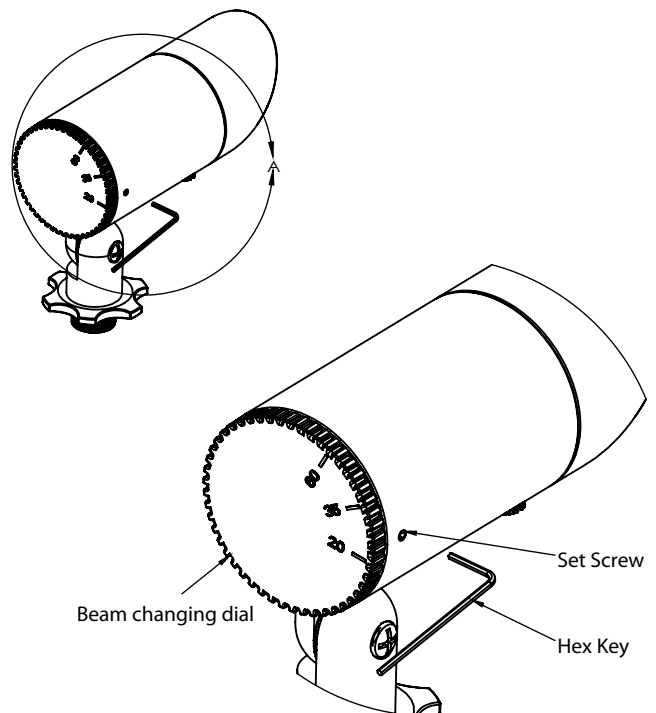
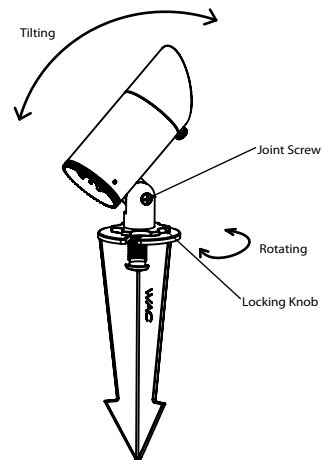
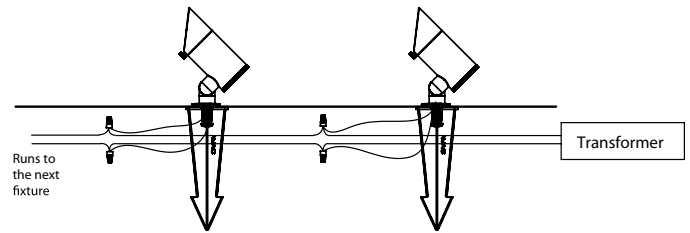

wacighting.com
Phone (800) 526.2588
Fax (800) 526.2585

Headquarters/Eastern Distribution Center
44 Harbor Park Drive
Port Washington, NY 11050

Central Distribution Center
1600 Distribution Ct
Lithia Springs, GA 30122

Western Distribution Center
1750 Archibald Avenue
Ontario, CA 91760

INSTALLATION INSTRUCTIONS

Interbeam Accent

5311

WAC LIGHTING

STEP 6: SHROUD ADJUSTMENT:

1. Loosen the thumb screw on the shroud.
2. Rotate the shroud until it is in the desired position to properly cut off glare.
3. Retighten the thumb screw to lock the shroud in place.

ACCESSORIES

1. Color Lens:

Colored lens come in red, blue, green and amber to filter the light coming out of the fixture.

Installation: Loosen the thumbscrew and remove the shroud. Place the colored lens into the fixture and secure by replacing the shroud.

2) Hex Louver

Hex louvers are used to reduce the glare of the fixture and control peripheral light.

Installation: Loosen the thumbscrew and remove the shroud. Place the hex louver into the fixture and secure by replacing the shroud.

3) Surface Mount Accessory:

The surface mount accessory is used to mount the fixture to a hard surface like wood or cement or as alternative to the mounting stake.

Installation: Mount the accessory to a hard surface using No. 10 Philips head screws that are at least half an inch long. If mounting on concrete or something similar, first use a plastic anchor sized for No. 10 screws. If mounting on a soft surface first attach the included spikes.

Create a route underneath the accessory for your wire to travel through. Lead your wire through the created route and screw your fixture onto the surface mount accessory.

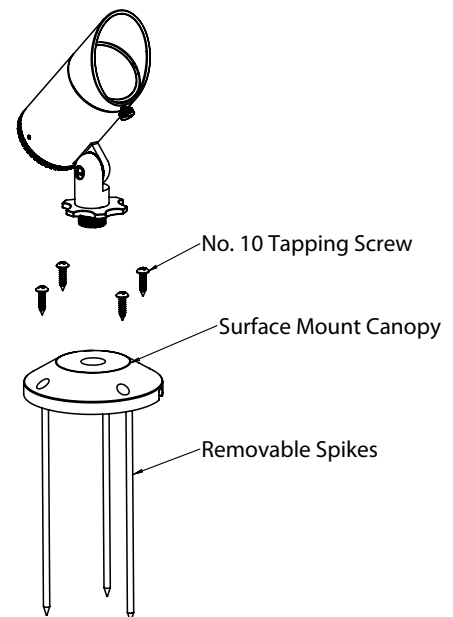
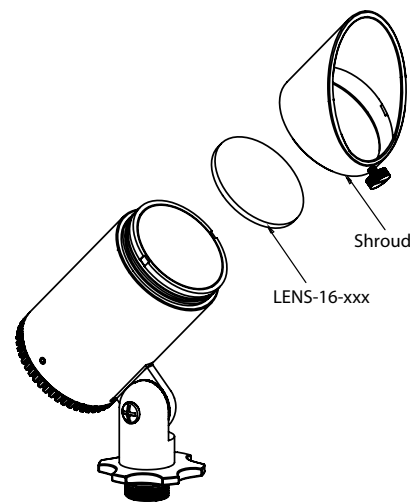
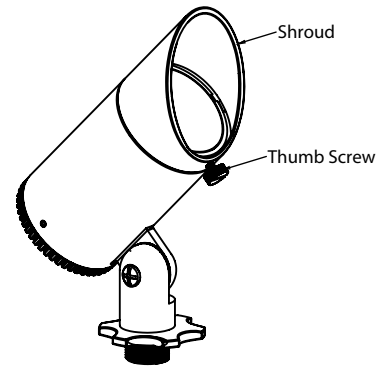

waclighting.com
Phone (800) 526.2588
Fax (800) 526.2585

Headquarters/Eastern Distribution Center
44 Harbor Park Drive
Port Washington, NY 11050

Central Distribution Center
1600 Distribution Ct
Lithia Springs, GA 30122

Western Distribution Center
1750 Archibald Avenue
Ontario, CA 91760

INSTALLATION INSTRUCTIONS

Interbeam Accent

5311

WAC LIGHTING

4) Tree Mount Accessory:

The tree mount accessory is a way for fixtures to be mounted on the trunk or a branch of a tree while minimizing damage to the tree.

Installation: Mark the screw hole locations at the point of installation. Screw the provided screw bolts into the tree until the unthreaded portion of the bolt meets the surface of the tree. Screw a hexnut onto bolt until it hits the unthreaded area. Place the tree mount bracket onto the bolts and secure using additional hex nuts. Attach light fixture and lead wire through the bracket.

5) Extension Accessory:

Using extension rods and rod joiners, fixtures can be mounted away from a surface in any desired direction. Rods come in 5 sizes: 4 inches, 8 inches, 12 inches, 18 inches, and 24 inches. These rods can be connected via either straight or 90-degree rod joiners.

Installation: Screw in a rod joiner into your mounting accessory. Screw an extension rod to the other side of the rod joiner. Continue to use rod joiners and extension rods until the fixture is in the desired position.

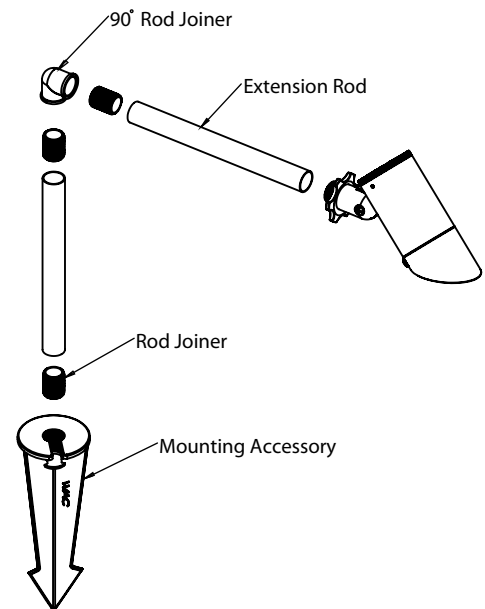
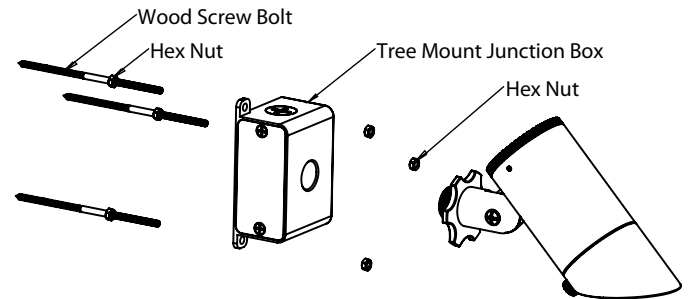

waclighting.com
Phone (800) 526.2588
Fax (800) 526.2585

Headquarters/Eastern Distribution Center
44 Harbor Park Drive
Port Washington, NY 11050

Central Distribution Center
1600 Distribution Ct
Lithia Springs, GA 30122

Western Distribution Center
1750 Archibald Avenue
Ontario, CA 91760