

Tools Required

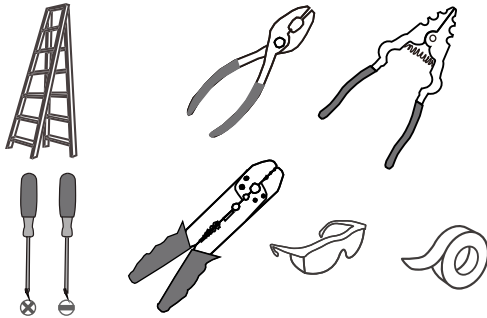

Light Source

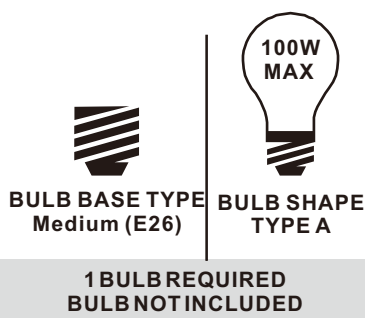

Fixture Height Adjustable 17.25" to 63.75"

Warnings and Cautions

Turn off the electricity at the circuit breaker before installation. Consult a licensed electrician if in doubt about installation.

Turn off power to the fixture and allow the bulbs to cool before replacing.

Package Contents

Preparation: Identify and inspect all parts before beginning the installation.

Missing or damaged parts? Contact your original place of purchase.

PARTS BAG

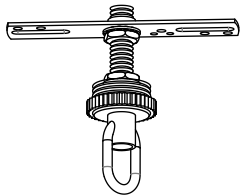

A Crossbar Assembly x 1



B Outlet Box Screw x 2

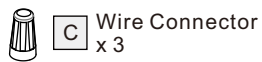

C Wire Connector x 3



D Quick Link x 2

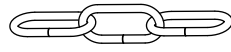

E Fixture Chain x 1

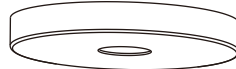

F Ceiling Canopy x 1

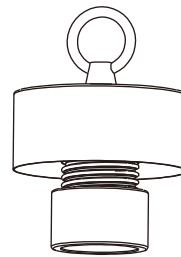

G Fixture Body x 1

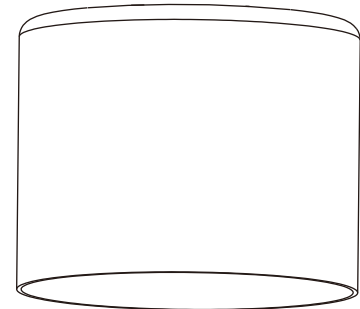

H Shade x 1

Table of Contents

Crossbar Assembly

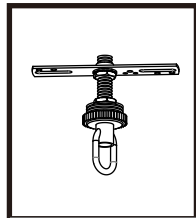

STEP 1

Fixture Chain

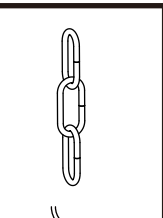

STEP 2

Wiring

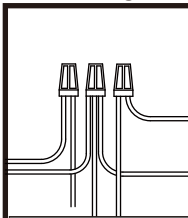

STEP 3

Ceiling Canopy

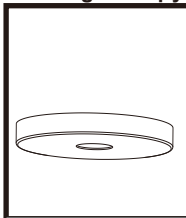

STEP 4

Shade and Bulb

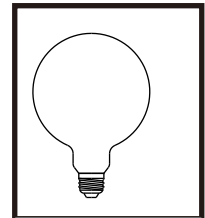

STEP 5

STEP 1

1

Step 1
Install crossbar assembly

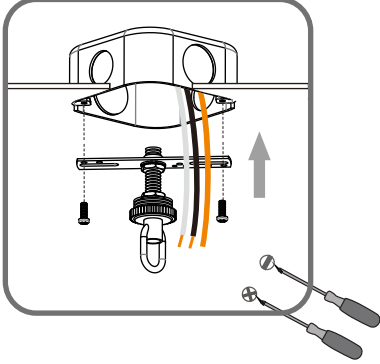

2

Step 2 - 3
Test fitting ceiling canopy to nipple

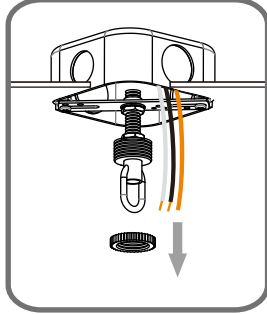

3

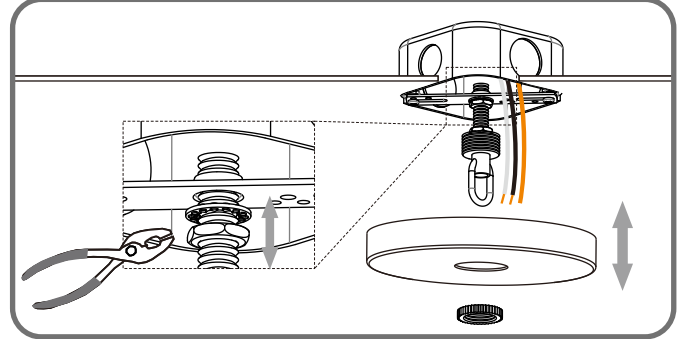

STEP 2

1

Step 1
Adjust fixture chain length

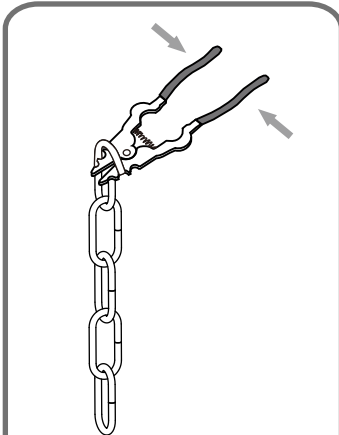

Suggested Chain Length:

8' ceiling: 19" Chain
9' ceiling: 31" Chain
10' ceiling: 43" Chain

2

Step 2 - 3
Install Fixture Chain

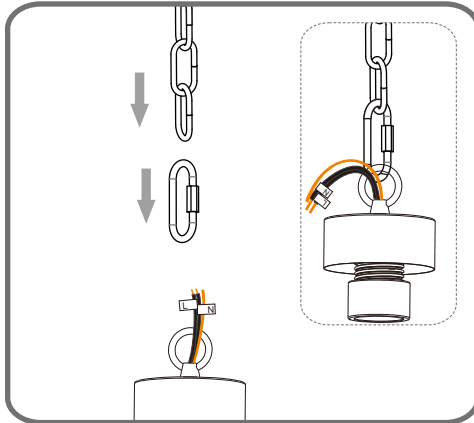

3

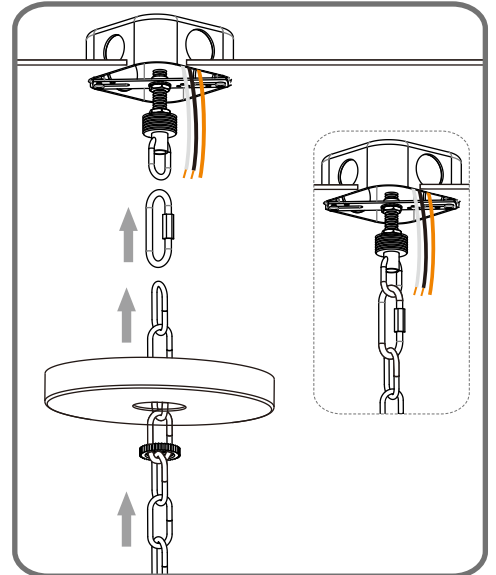

STEP 3

1

Step 1
Feed the fixture wires
through the loop

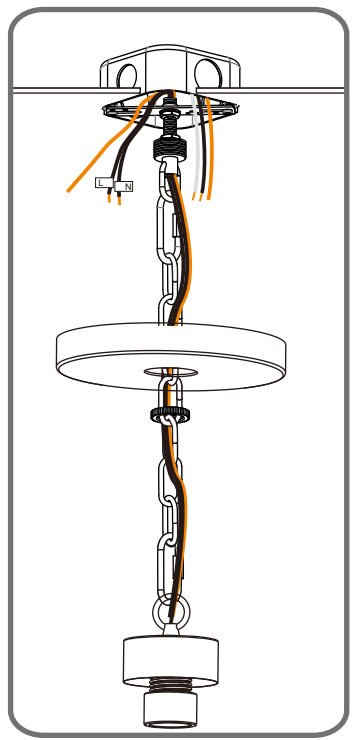

2

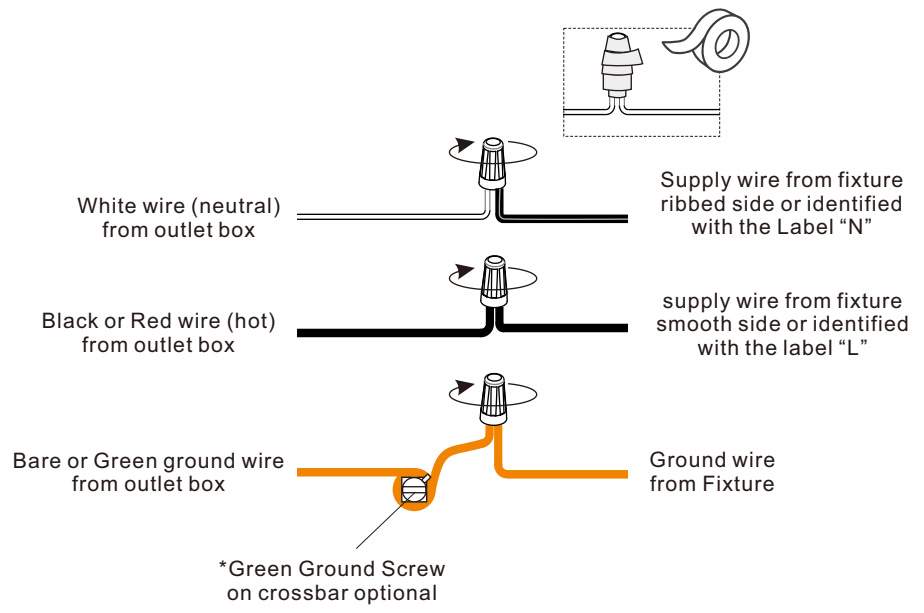

STEP 4

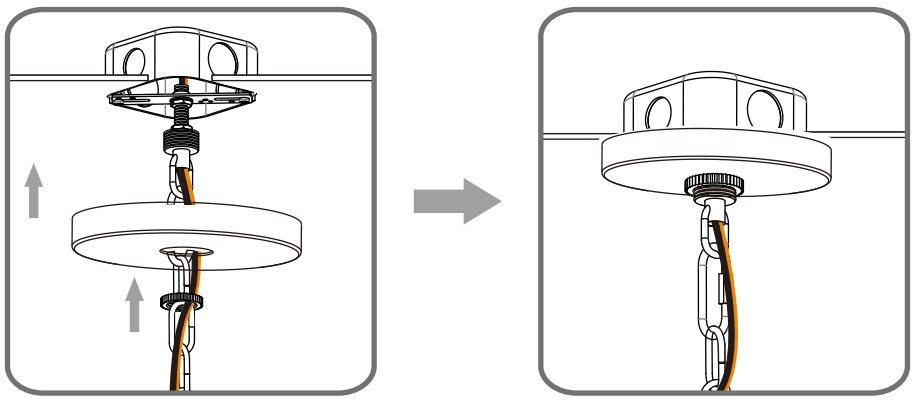

STEP 5

