

MAINTENANCE:

Use a soft, lint - free cloth to clean the metal frame.

**UNDER NO CIRCUMSTANCES
SHOULD METAL POLISHES, CLEANERS,
ABRASIVES OR AEROSOL SPRAYS
BE USED.**

While the latest finishing techniques have been used on the metal frame, such finish cannot be unconditionally guaranteed. The main cause of deterioration, apart from certain atmospheric conditions, is improper cleaning.

To clean the crystals, polish with a damp chamois.

You are cleaning delicate jewelry... Take the greatest care.

IMPORTANT:

Do not clean crystals in a dishwasher. The finish of the metal clips and hangers will be ruined and the crystals may be damaged.

SCHONBEK®

CHANDELIER 3587- _____ - _____ TRIM DIAGRAM

(Finish Option)

(Trim Option)

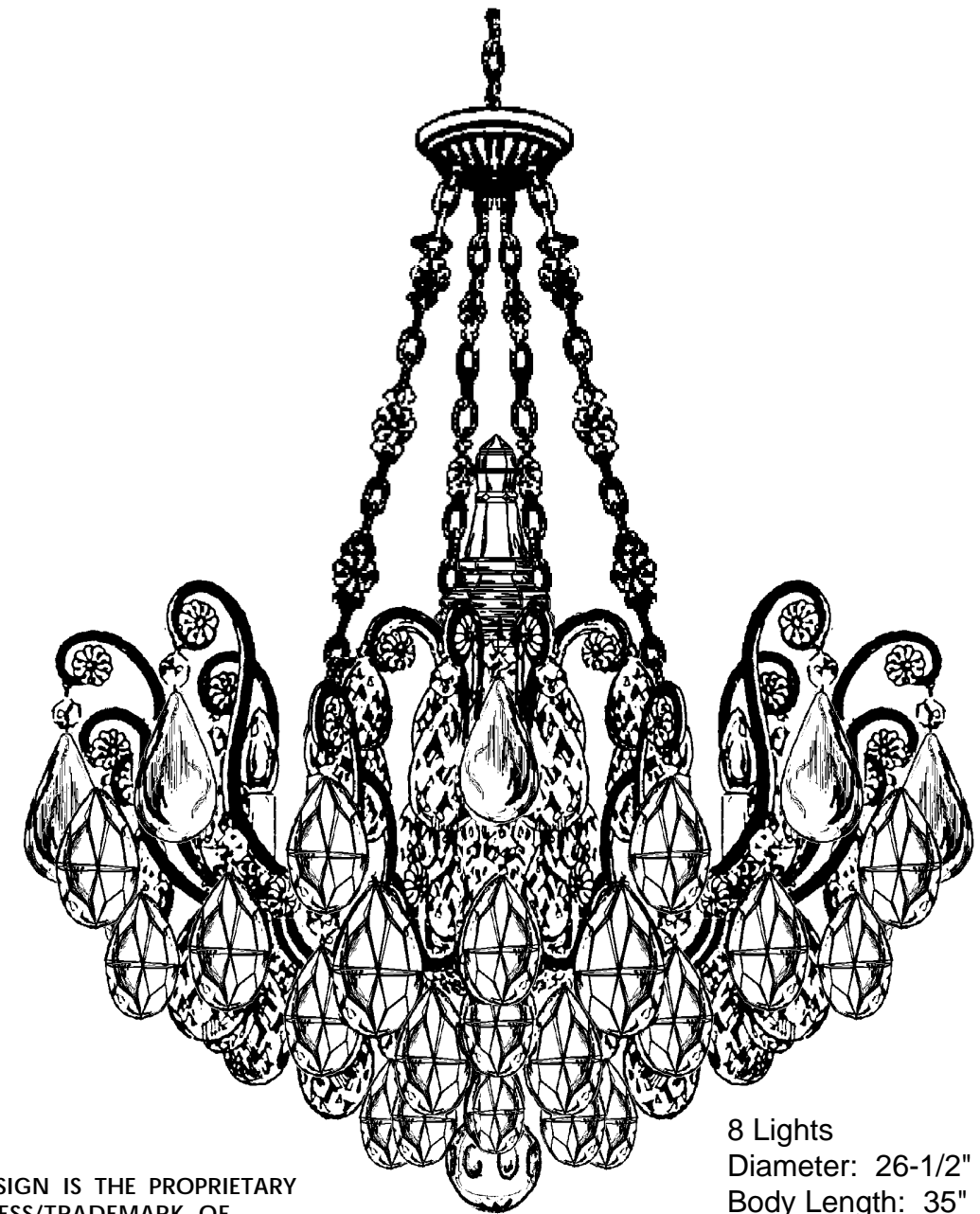

THIS DESIGN IS THE PROPRIETARY
TRADE DRESS/TRADEMARK OF
SCHONBEK WORLDWIDE LIGHTING INC.

8 Lights
Diameter: 26-1/2"
Body Length: 35"
Hanging Weight: 37 lbs.

SCHONBEK®

**Follow steps in exact order
Save this trim diagram for future reference**

1

IMPORTANT

Person who opens carton should record the following information for future service.

CODE # _____ Four-digit number on outside of carton.
PACKER # _____ See crystal package label.
ORDER # _____ See crystal package label.

Instructions for electrician

STEPS 2 - 21

WARNING:

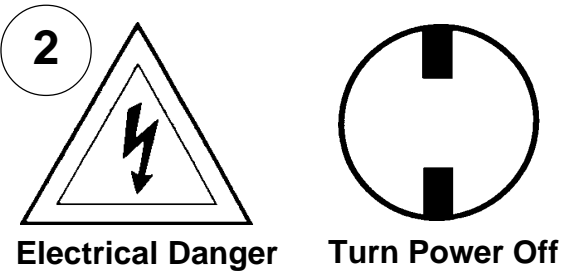

All electrical components must be installed by a licensed electrician in accordance with the National Electric Code and the appropriate local electrical codes.

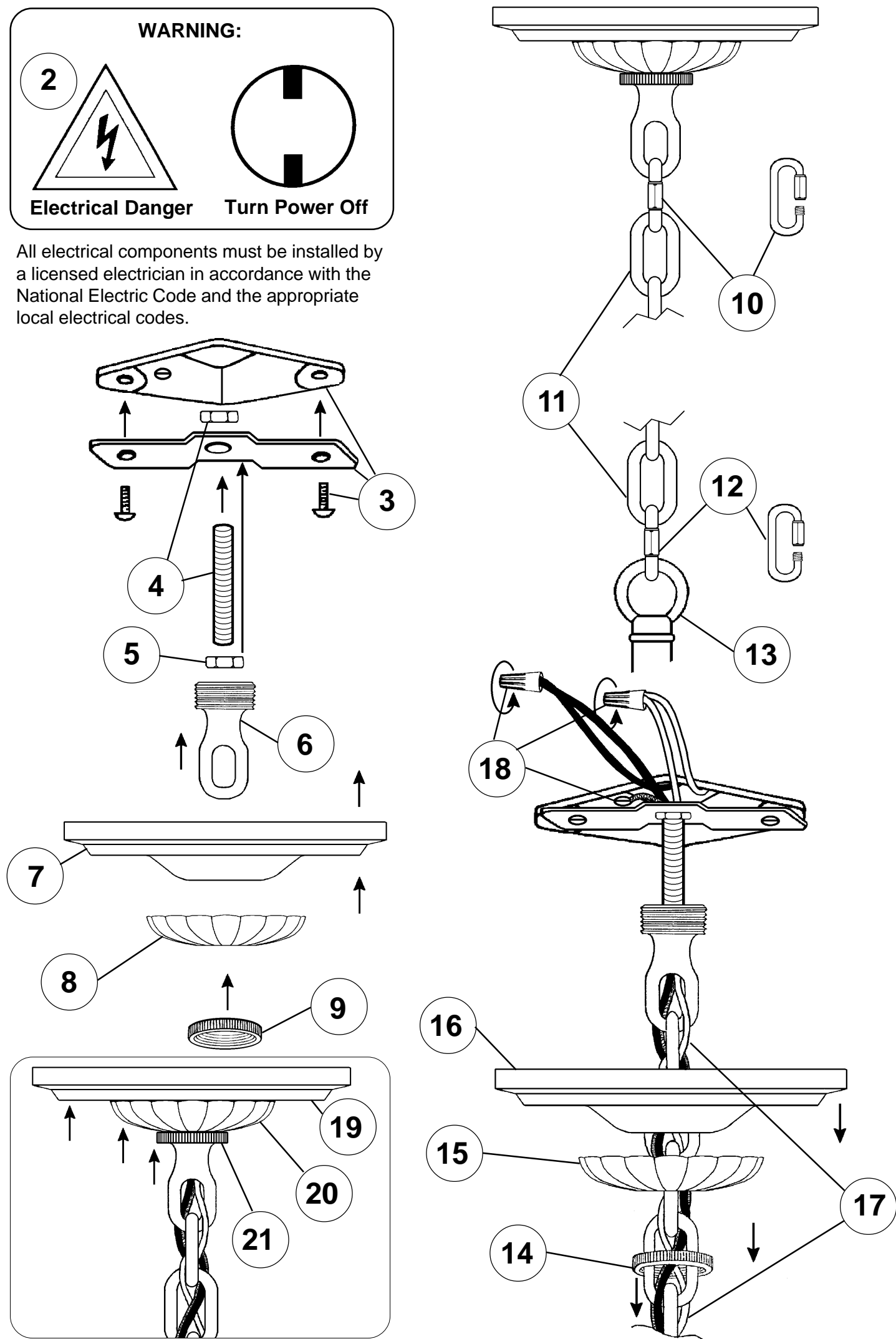

SET #1

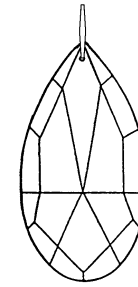

B
(N10263**)
2-1/2"
63mm

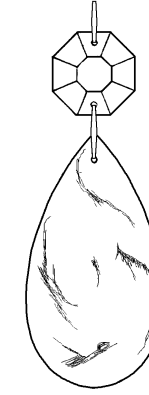

C
(N10272)
2-1/2"
63mm

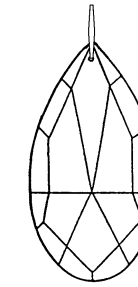

D
(N10263)
2-1/2"
63mm

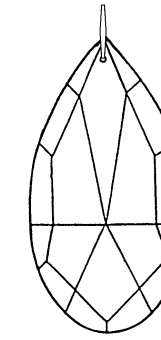

F
(N8250)
3"
76mm

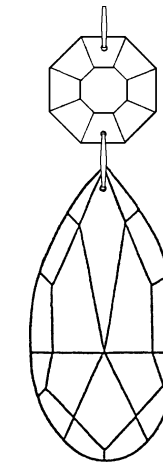

G
(N10191**)
3"
76mm

SET #2

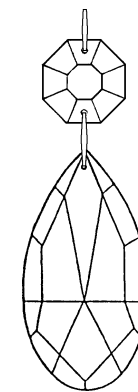

A
(N10223**)
2-1/2"
63mm

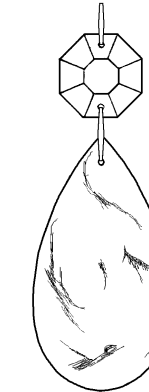

C
(N10272)
2-1/2"
63mm

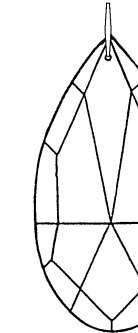

F
(N8250)
3"
76mm



G
(N10191**)
3"
76mm

SET #3

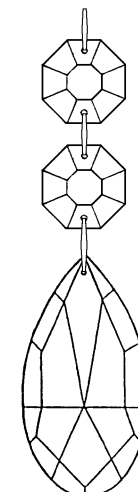

H
(N10275**)
2-1/2"
63mm

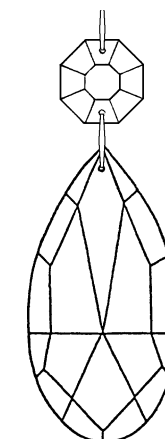

J
(N10273)
3"
76mm



K
(N10273**)
3"
76mm



L
(N10276)
3-1/2"
89mm

Crystal Set #3 in Black

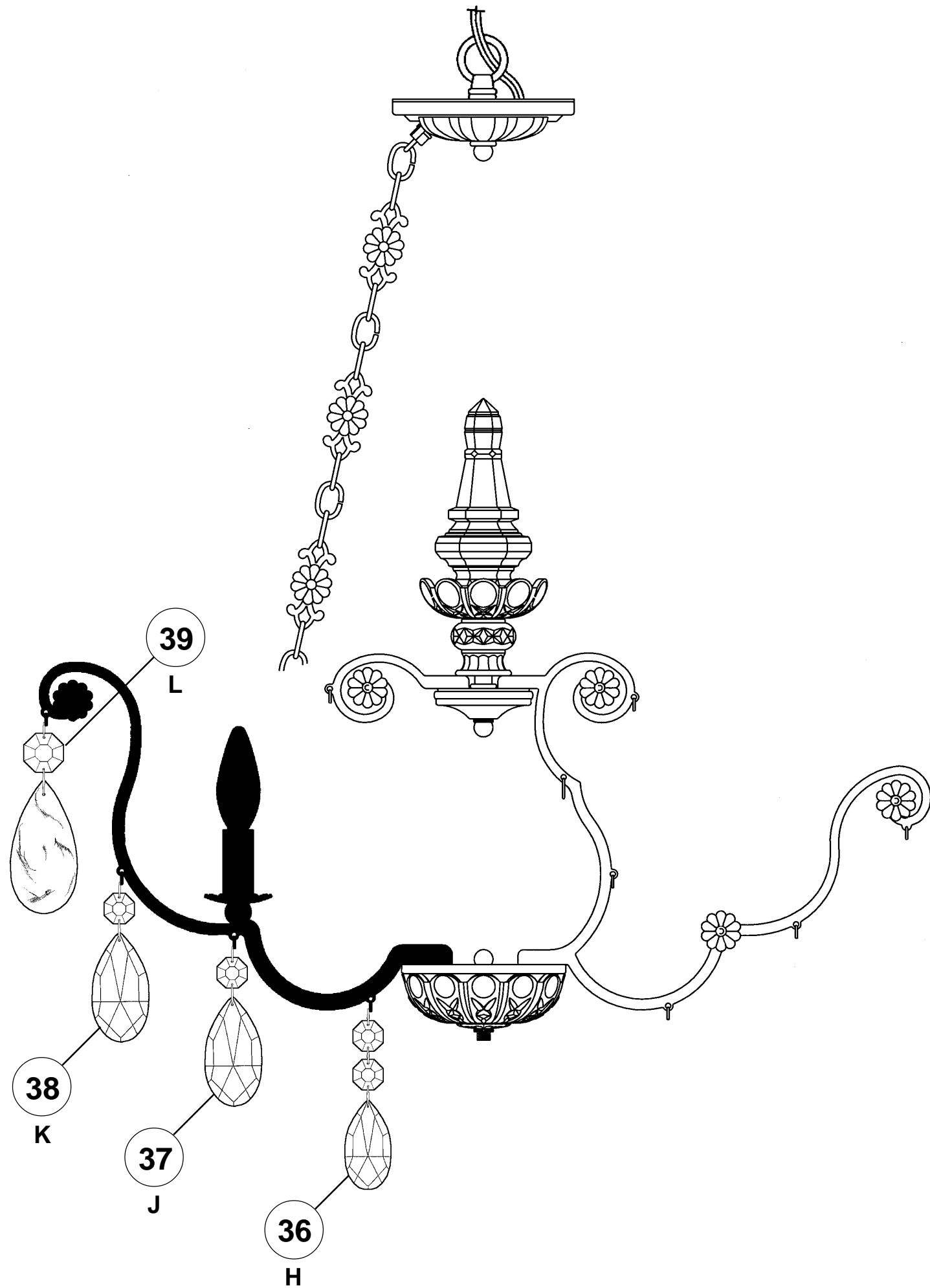

For easy removal of crystal from bubble pack, please cut along pouches on the inside of the seam. Gently remove crystal from the side of the pouch.

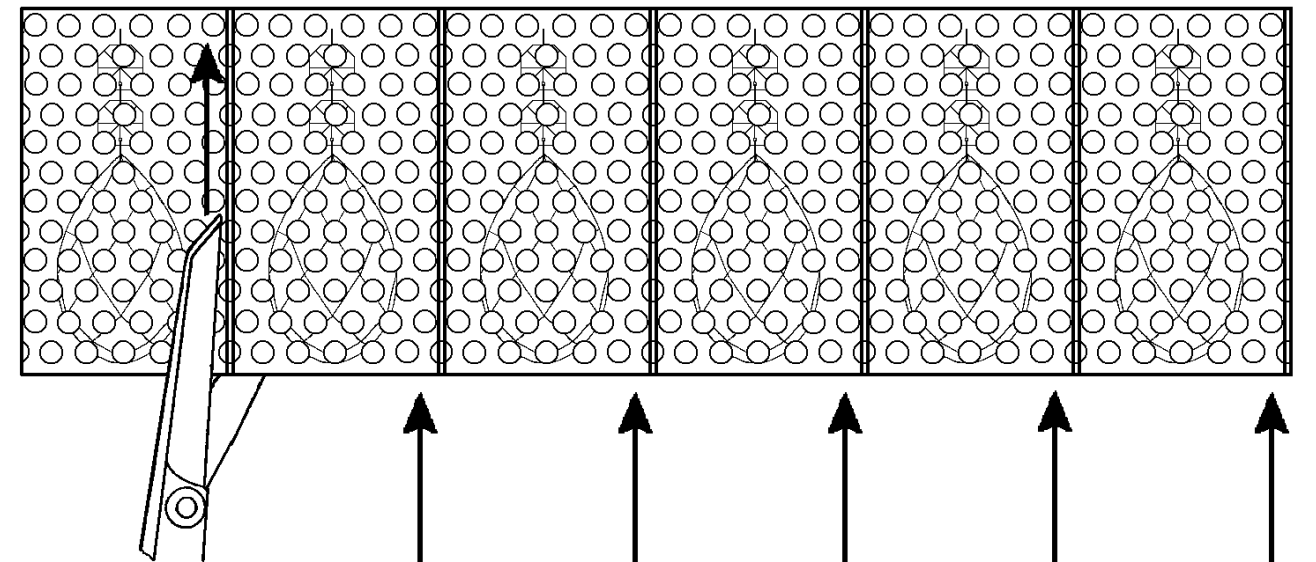

NOTE: Work on one crystal set at a time. Follow the black line from top to bottom according to the numbered steps on the trim diagram.

Instructions for crystal trimming
STEPS 22 - 39

FIXTURE INCLUDES:
 Hanger Hardware
 Trim
 Frame
DOES NOT INCLUDE:
 C10 - Light Bulbs

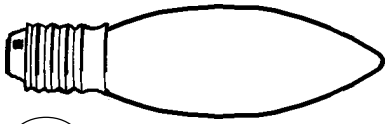

22

You will need 8 - C10
 25 Watts Recommended
 60 Watts Max

Install bulb and be sure
 to test fixture **BEFORE**
 trimming.

Crystal Set #2 in Black

Crystal Set #1 in Black

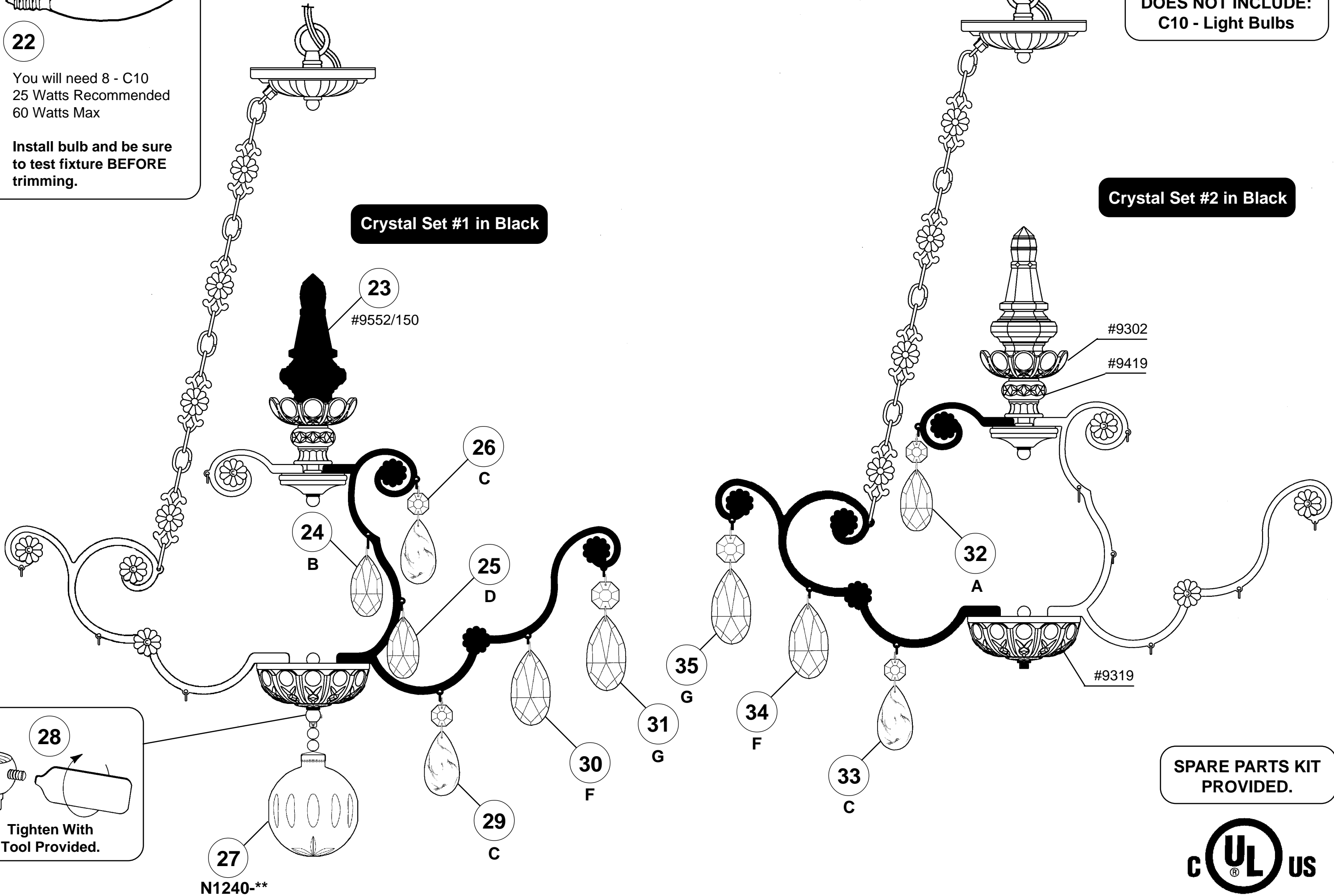
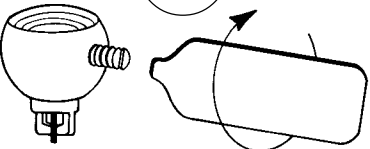
28

Tighten With
 Tool Provided.

**SPARE PARTS KIT
 PROVIDED.**

