

Kimberly
8970

Project Name _____

Fixture Type _____

Quantity _____

Norwell | Lighting

I L E X

Custom Metalcraft



Kimberly
8970-BN-CL



Kimberly
8970-PN-CL

8970

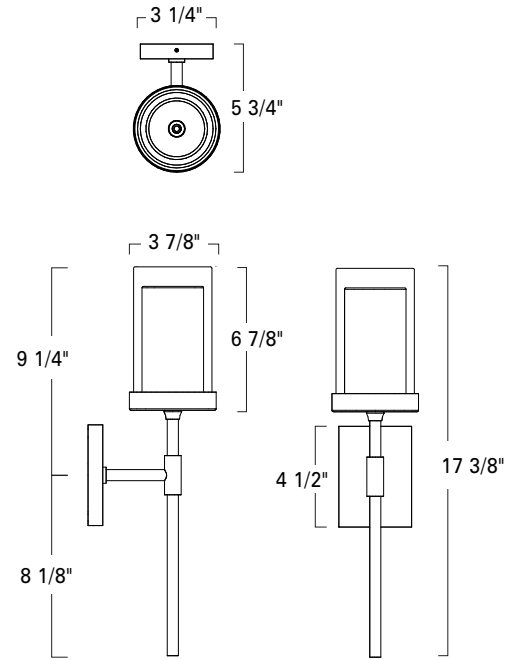

Product Name / Model / Dimensions			Finish Options	Glass Options	Lamping Options
Kimberly - 8970			Standard Brushed Nickel / BN Chrome / CH Polished Nickel / PN	Standard Clear Outer White Inner Glass (CL) 5.75" H X 4" W	Standard Incandescent / IN (1) 60 Watt Candelabra
Height	Width	Projection			
17.375"	4.50"	5.75"			
Backplate* 4.50" H x 3.25" W *Trimplate available Note: Small backplate requires a switch box					

Damp Location and UL/ETL Listed

3-2021

DISCLAIMER:

Norwell Lighting and its companies, ILEX Architectural Lighting and Custom Metalcraft reserve the right to change specifications related to its product at anytime. USA Made indicates product is manufactured in East Taunton, Massachusetts facility. Phone: 508-823-1751