

# Installation Guide

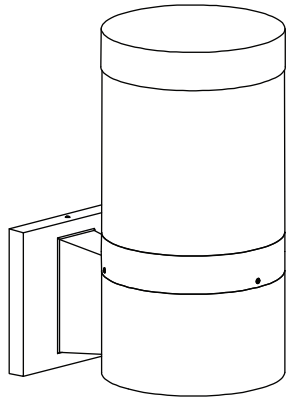

VONN Lighting  
Model: VOW1756



## LED INFO & WARNINGS

- Please read and comprehend the entire manual before attempting to assemble, operate, or install the product.
- Make sure that you have all necessary parts by checking the parts list. If any part is missing or damaged, please contact **VONN Lighting Customer Service at 888-604-8666** for a replacement.
- All parts must be used as indicated in these instructions. Do not substitute any parts, leave parts out, or use any parts that are worn or broken.
- Inspect the LED fixture prior to installation to make sure that it has not been damaged during shipping.
- Please handle the LED light with care when unpacking. Do not apply pressure to the LED's, do not open any factory sealed compartments, and do not touch the LEDs with your hands.

VONN highly recommends to use a qualified, licensed electrician to install the fixture.

- Do not remove or replace VONN manufactured parts that are provided with the fixture.
- Shut "OFF" the electricity at main fuse box.

## Parts List

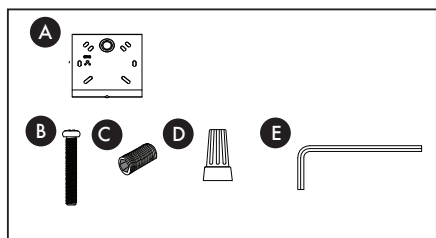

- A. Mounting Plate
- B. Mounting Screw x 3
- C. Hex Screws x 2
- D. Wire Connectors x 4
- E. Hex Wrench

## Circuit Box

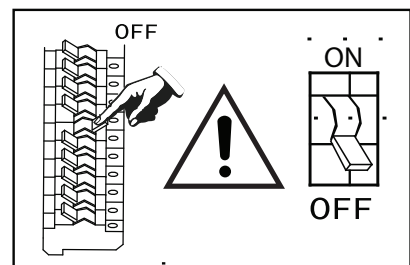

## Tools You May Need

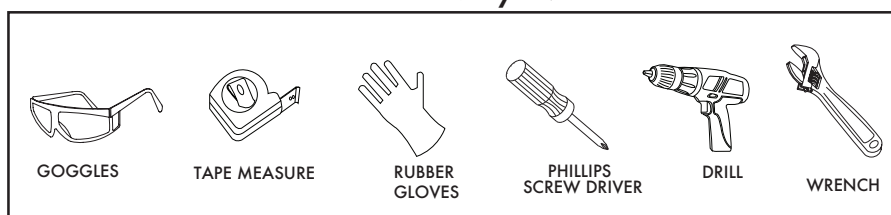

**Legend**

**L** = Live/Hot/Black

**N** = Neutral/White

 = Ground/Green

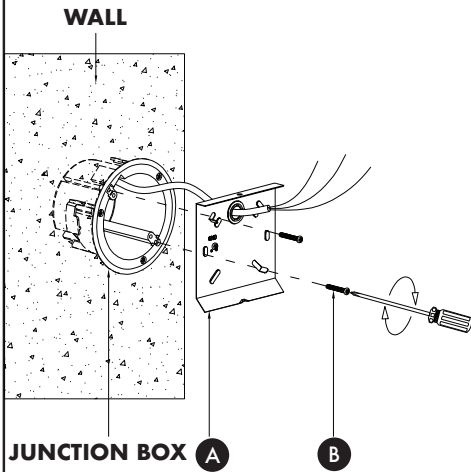

**1. Install Mounting Plate**

- Slip wires through mounting plate (A) before attaching to junction box. Secure mounting plate (A) to junction box with mounting screws (B).

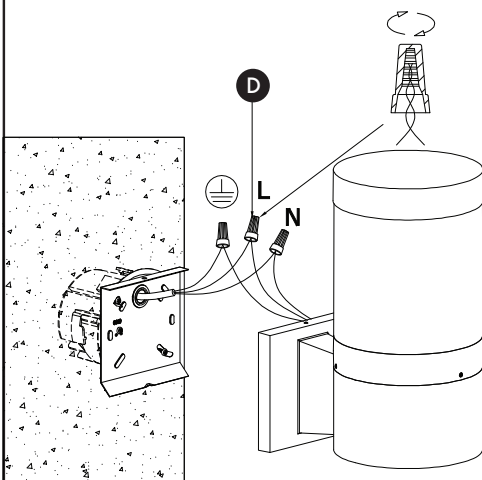

**2. Supply Wires:**

- Connect Black (Line Wire) from fixture to power Black (Hot Wire).
- Connect White (Neutral Wire) from fixture to power White (Neutral Wire).
- Ground Wires:**
- Connect Green (Ground Wire) from fixture to supply Green (Ground Wire).
- Twist wires together clockwise and secure with wire connector (D).

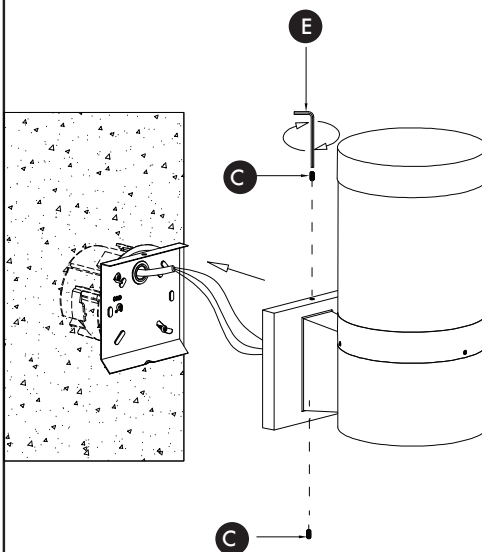

**3. Install Sconce**

- Install fixture to mounting plate (A). Secure fixture with hex screw (C). Tighten hex screw (C) with hex wrench (E).

**4. Turn Power ON**

- Turn electricity "ON" at main fuse box.

