

WARNING: DISCONNECT POWER AT THE MAIN FUSE BOX BEFORE INSTALLATION.

WARNING:

This fixture is intended for installation in accordance with the National Electrical Code (NEC) and all local code specifications. If you are not familiar with code requirements, installation by a certified electrician is recommended.

Before assembly, remove all parts and part packages from box. If anything is missing, please contact the retailer from which the product was purchased.

elk HOME

ANY QUESTIONS CALL: 800-613-3261
M-F 8:00AM-6:00PM ET

ITEM#: 96151/2

1. Carefully pull house wires out of junction box so house wires are easily accessible during installation.
2. Position mounting bracket (A) so threaded ends of attached fixture mounting screws (E) are pointing outwards.
3. Carefully pull house wires through hole in center of mounting bracket (A).
4. Align holes in mounting bracket (A) with each hole in junction box. Fixture mounting screws (E) should be level.
5. Thread one junction box screw (B) into each hole in mounting bracket (A) and into holes in junction box. Tighten junction box screws (B) to secure mounting bracket (A) to junction box.
CAUTION: Make sure house wires are pulled completely through hole in mounting bracket.
DO NOT pinch wires between mounting bracket and wall.

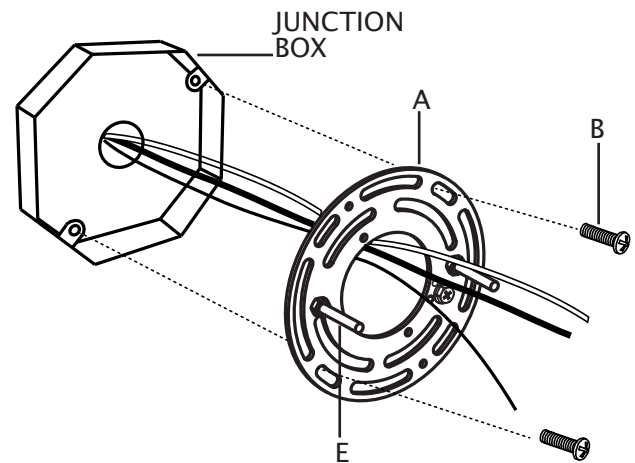

6. Strip 3/4" of insulation from ends of fixture wires.
7. Slightly loosen ground screw on mounting bracket (A). Do not completely remove ground screw. Wrap house ground wire (copper) around ground screw, leaving enough ground wire to attach to fixture ground wire. Twist end of fixture ground wire and end of house ground wire together. Twist wire nut (C) onto ends of wires. Completely tighten wire nut (C). Reference chart below for correct wire connections.

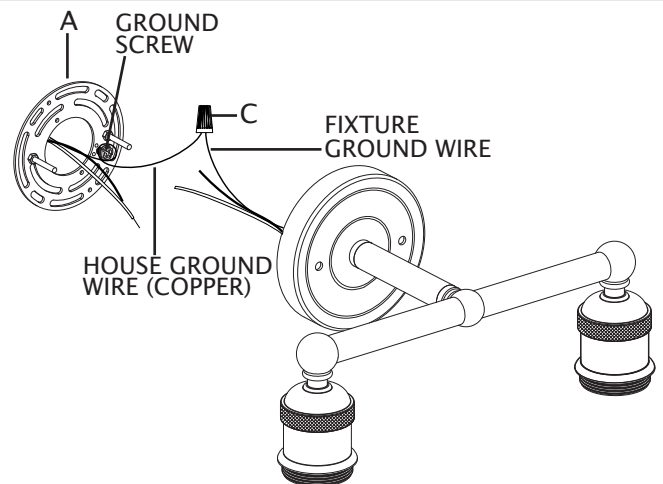

Connect Supply (House) Ground Copper Wire to:

Bare Copper Wire or,

Bare Silver Wire or,

Green Insulated Wire.

8. Twist end of house lead wire (black) and end of fixture lead wire together. Twist wire nut (C) onto ends of wires. Completely tighten wire nut (C). Twist end of house neutral wire (white) and end of fixture neutral wire together. Twist wire nut (C) onto ends of wires. Completely tighten wire nut (C). Reference chart to the right for correct wire connections.
9. Wrap electrical tape (not included) around wire nuts (C) and wires. Ensure wires are securely fastened into wire nuts.
10. Carefully push all wires and wire nuts into junction box.

Connect Black Lead Supply (House) Wire to:	Connect White Neutral Supply (House) Wire to:
Black Wire or,	White Wire or,
*Parallel Cord (Round and Smooth) or,	*Parallel Cord (Square and Ridged) or,
No printed words on wire insulation or,	Printed words on wire insulation or,
Insulated Wire (other than green) with Copper Conductor.	Insulated Wire (other than green) with Silver Conductor.

*When parallel wire (SPT 1 & SPT 2) is used:
The lead wire is round in shape or smooth.
The neutral wire is square in shape or ridged.

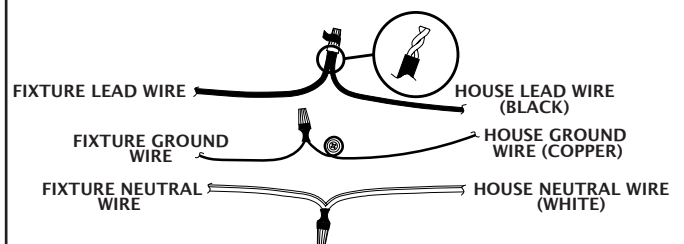

11. Place backplate (D) over mounting bracket (A). Pass holes in backplate (D) over ends of fixture mounting screws (E).
12. Screw one threaded ball (F) onto each fixture mounting screw (E). Tighten threaded balls (F) to secure fixture to wall.
13. Pass hole in top of trim ring (M) over socket. Thread socket ring (N) onto socket. Tighten socket ring (N) to secure trim ring (M) in place. DO NOT over tighten.
14. Raise shade (K) up to fixture. Fit top of shade (K) inside trim ring (M).
15. Thread one thumbscrew (L) into each hole along trim ring (M). Equally tighten thumbscrews (L) to secure shade (K) in place. DO NOT over tighten.
16. Screw recommended bulbs (E26 Edison bulb type, not included) into sockets. Verify correct bulb wattage marked on socket of fixture.
WARNING: DO NOT exceed maximum bulb wattage.

