

Please go to [www. quozel. com](http://www. quozel. com) for product cleaning tips. Go to the **Care + Maintenance** selection.

**Tools Required:** Flathead screwdriver, Phillips screwdriver, pliers, wire cutters, wire strippers, electrical tape, safety glasses.

**Light Source:** (3) A19 Medium Base bulbs 100W Maximum or  
(3) Medium Base Vintage bulbs are recommended but not supplied.

**Estimated Assembly Time:** 20-30 minutes

**Preparation:** Identify and inspect all parts before beginning installation. Check package content list and diagrams below to be sure all parts are present. If any parts are missing or damaged, do not attempt to assemble, install, or operate the fixture. Contact customer service for replacement parts.

## ⚠ Warnings and Cautions

Turn off electricity at circuit breaker or main fuse box before installation. Consult a licensed electrician if in doubt.

These instructions are provided for your safety. It is very important you read them completely before installing the fixture. We strongly recommend that a licensed, professional electrician perform the installation.

Disconnect fixture from power source before replacing bulbs. Make sure bulbs are given sufficient time to cool before removal.

## Package Contents

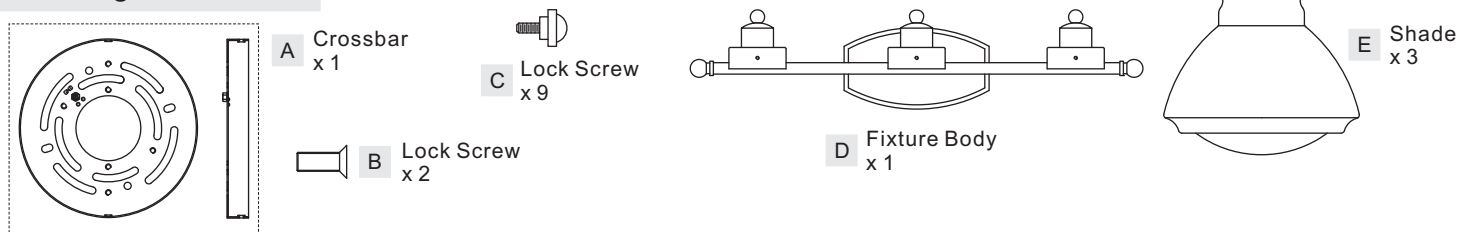

### STEP 1 - Install the Crossbar to the junction box

A. Attach the Crossbar (A) to the Outlet Box with the head of the Green Ground Screw facing you. Secure it with Outlet Box Screws (not included), tighten until snug.

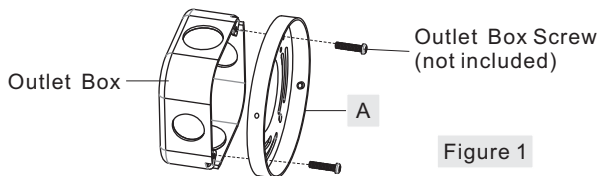

### STEP 3 - Install Fixture Body

A. Place the Backplate and the Fixture Body (D) over the Crossbar (A). Line up Holes on the side of backplate and the Mounting Hole on the Crossbar (A). Secure by threading Lock Screws (B) into the Crossbar (A). Tighten until snug.

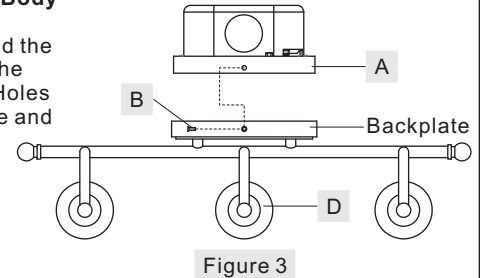

### STEP 2 - Making the Wire Connections

A. Use standard wire connectors (not included) to make all wire connections. Twist connectors until wires are tightly joined together. Wrap each connection with approved electrical tape and carefully stuff all the connected wires into outlet box.

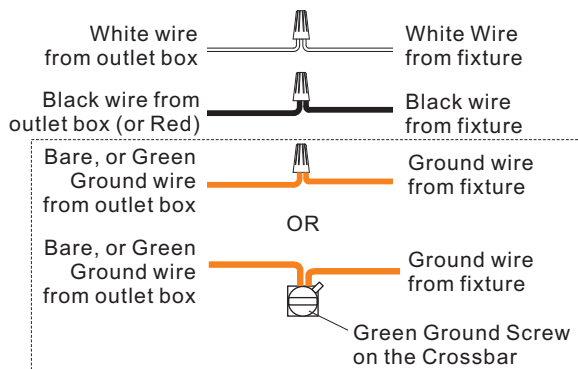

### STEP 4 - Install Bulb and Shade

A. Insert bulb onto socket and screw snugly into place.  
B. Place Shade (E) into socket cup and hold it by hands. Thread Lock Screws (C) into mounting holes on socket cup until it is attached to the neck of Shade (E). Please make sure the Shade (E) is held well before you release your hands.

Your fixture is now assembled and ready to use. Enjoy!

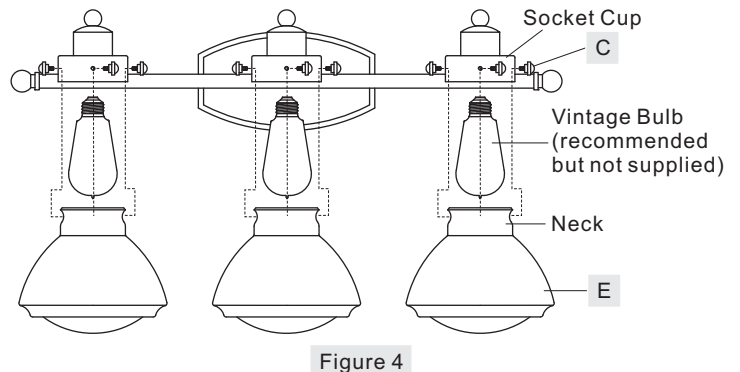

Thank you for purchasing a Quoizel product.  
Need assistance with parts or assembly? Call Quoizel customer service at 1-800-645-3184  
or visit us on-line at [www. quozel. com](http://www. quozel. com)

SCH8603PN

FINISH: PALLADIAN BRONZE

NOTE: ALL DIMENSIONS ARE ROUNDED UP TO THE NEAREST 1/4"

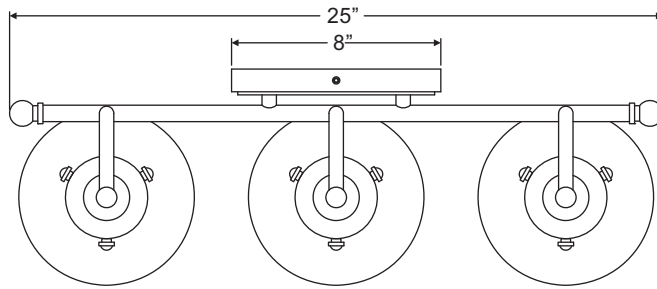
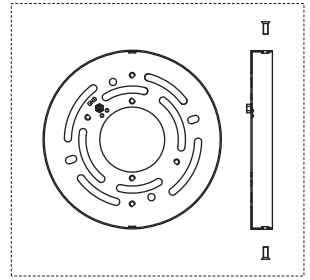
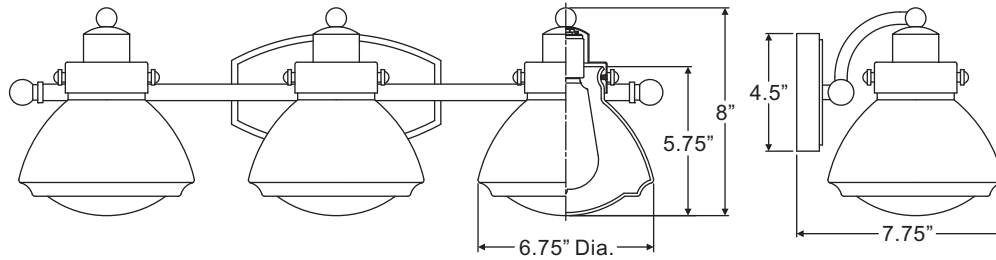

Thank you for purchasing a Quoizel product.  
Need assistance with parts or assembly? Call Quoizel customer service at 1-800-645-3184  
or visit us on-line at [www.quoizel.com](http://www.quoizel.com)