

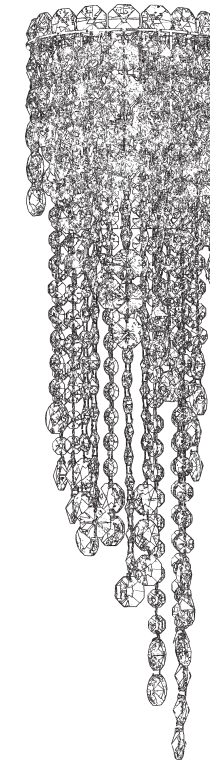

SCHONBEK®

CHANTANT
CH0833N- __ __ H



THIS DESIGN IS THE PROPRIETARY
TRADE DRESS/TRADE MARK OF
SWAROVSKI LIGHTING, LTD.

2 Lights
Length: 6-1/2"
Height: 23"
Extension: 6"
Hanging Weight: 6lbs.



SCHONBEK®

MAX 40 W		110-120 V						

2 X  : G9 40W MAX 

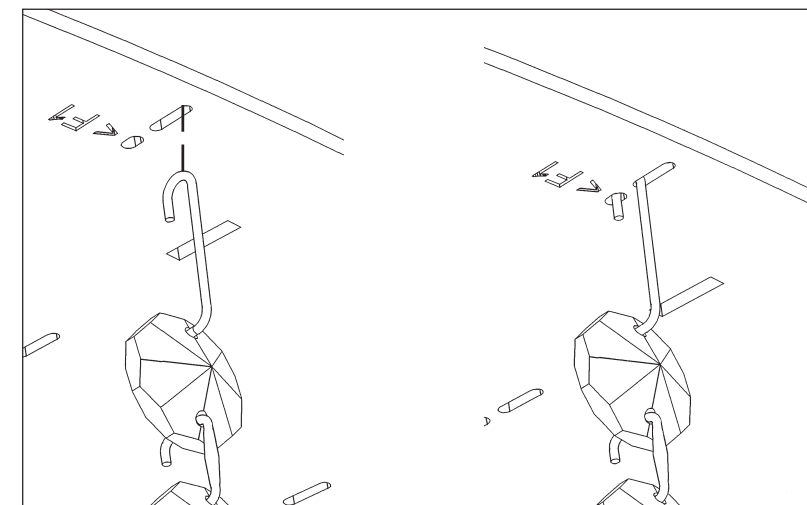
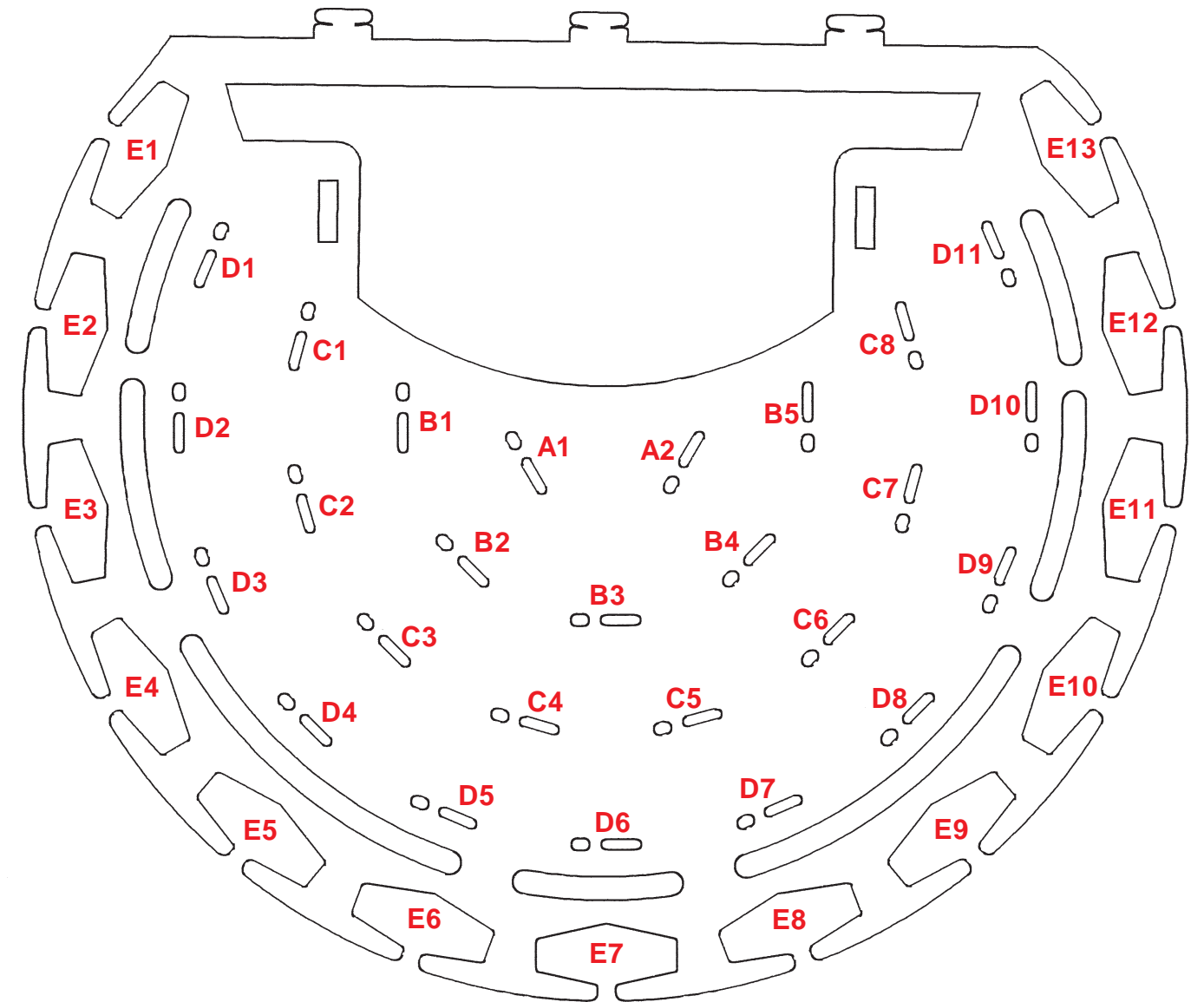
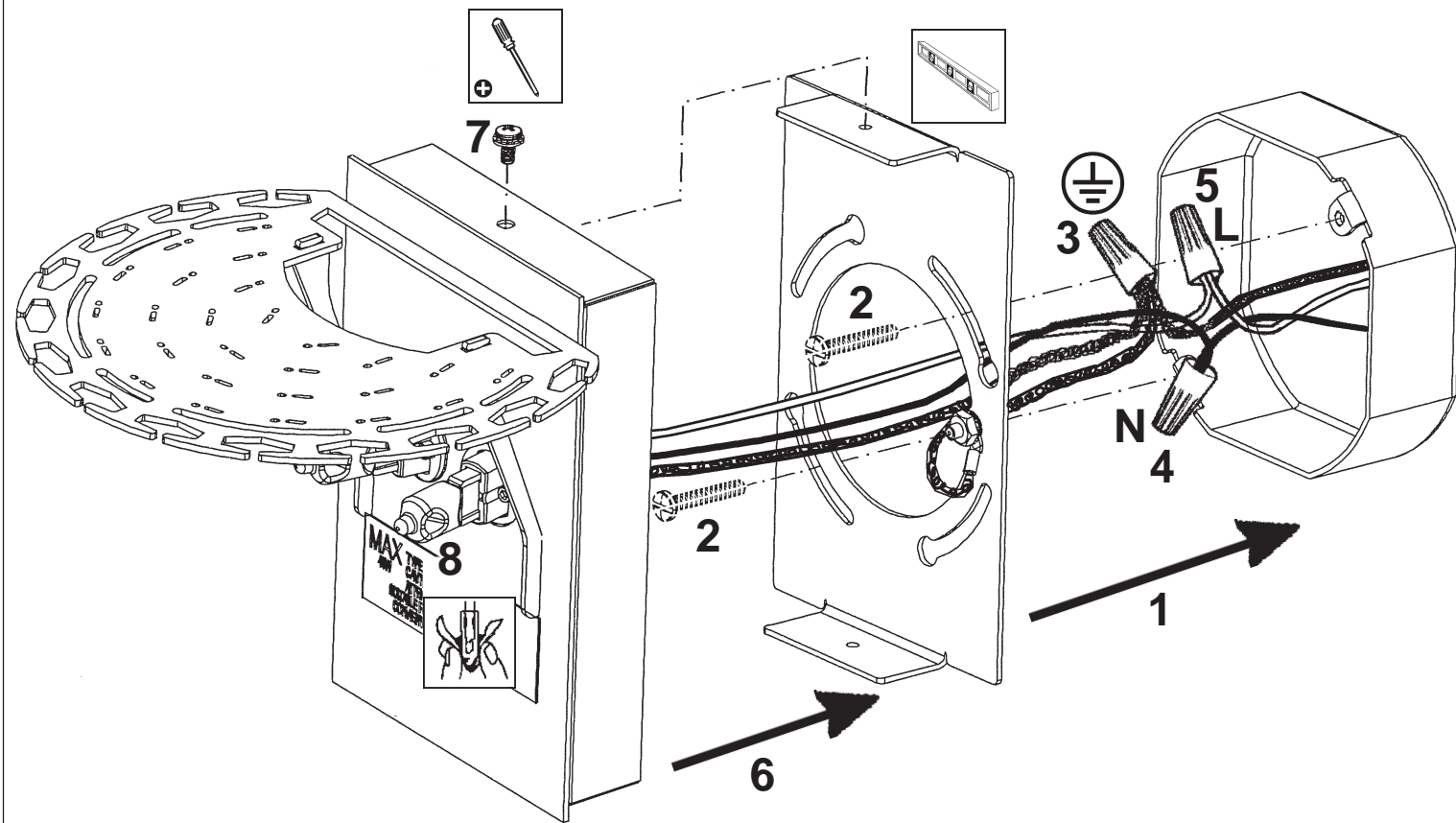

- 9 A1 - A2
- 10 B1 - B5
- 11 C1 - C8
- 12 D1 - D11
- 13 E1 - E13

After hanging all trim, remove labels from crystals. If residue remains, wipe off crystal with a soft, dry cloth.