

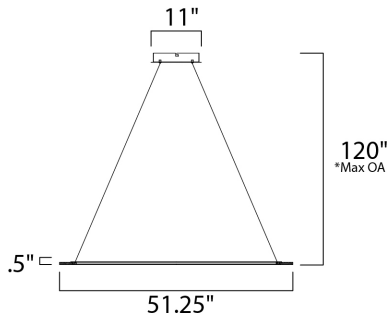

PRODUCT DESCRIPTION

A new variation of a very popular series with many different configurations many of which are large scale for commercial applications. Metal rings of Matte Silver support horizontal acrylic diffusers which glow when illuminated by dimmable LED.



*max overall height

MEASUREMENTS

- DIMENSION : 51.25" L x 51.25" W x 0.5" H
- MAX OAH : 120" OAH
- CANOPY : 11" W x 2" H x 11" L
- HANGING WEIGHT : 25.3 lb

LAMPING

- INPUT VOLTAGE : 120V
- LUMENS : 3,500 Rated (2,440 Del.)
- BULB : 1 x 50W LED PCB Integrated , 50W Total
- BULB INCLUDED : (Integrated)
- DIMMABLE : Triac CL
- CRI : 80+ CRI
- COLOR_TEMP : 3000K

FINISHES OPTION



GLASS

Matte White 11

MATERIAL

Aluminum, Acrylic

RATINGS

cETLus
Dry Location



ADDITIONAL

ADJUSTABLE
OPERATING TEMPERATURE:
-20°C (-4°F), 40°C (104°F)

Always consult a qualified electrician before installing any lighting product.



Contemporary
Lighting™

WESTERN DISTRIBUTION CENTER (HEADQUARTER)
253 NORTH VINELAND AVE | CITY OF INDUSTRY, CA 91746

EASTERN DISTRIBUTION CENTER
4200 SHIRLEY DR. | ATLANTA, GA 30336

P. 626.956.4200 | F. 626.956.4225 | et2online.com