

Quoizel, Inc.
6 Corporate Parkway
Goose Creek, SC 29445

Customer Service
Phone 631.273.2700
Fax 631.231.7102
www. quozel. com

Tools Required: Flathead screwdriver, Phillips screwdriver, pliers, wire cutters, wire strippers, electrical tape, safety glasses.

Bulb Recommended: (2) Medium Base 60W bulbs Maximum, Alternate bulb (2) 13W CFL Maximum.

Estimated Assembly Time: 20-30 minutes

Preparation: Identify and inspect all parts before beginning installation. Check package content list and diagrams below to be sure all parts are present. If any parts are missing or damaged, do not attempt to assemble, install, or operate the fixture. Contact customer service for replacement parts.

⚠ Warnings and Cautions

Turn off electricity at circuit breaker or main fuse box before installation. Consult a licensed electrician if in doubt.

These instructions are provided for your safety. It is very important you read them completely before installing the fixture. We strongly recommend that a licensed, professional electrician perform the installation.

Disconnect fixture from power source before replacing bulbs. Make sure bulbs are given sufficient time to cool before removal. Do not subject glass parts to any shock while in operation or shattering may result.

Package Contents

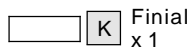
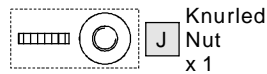
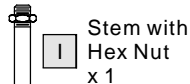
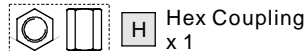
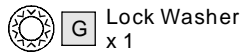
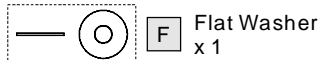
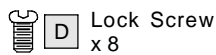
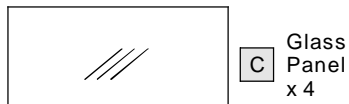
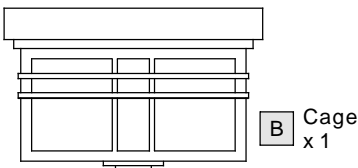
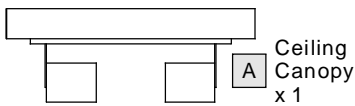

- Thread one Hex Nut (CC) to the middle of the Nipple (DD). Place the Lock Washer (BB) over the Nipple (DD) and then thread the Nipple (DD) into the Crossbar (AA) until the Nipple (DD) is about 0.375" above the Crossbar (AA).
- Position the center hole of the Ceiling Canopy (A) over the end of the Nipple (DD). Adjust the Nipple (DD) so approx 0.375" of the Nipple (DD) is protruding from the mounting hole on the Ceiling Canopy (A). This adjustment may take a few tries.
- Remove the Ceiling Canopy (A) and then tighten the Hex Nut (CC) against the Crossbar (AA) to secure in place.
- Thread another Hex Nut (CC) onto the end of the Nipple (DD). Thread this Hex Nut (CC) on just enough so the inside surface of the Ceiling Canopy (A) rests against it. * You may have to trial fit the Ceiling Canopy (A) one more times to insure this distance also. This Hex Nut (CC) is needed here to prevent you from crushing down the center of the Ceiling Canopy (A).
- Refer to Step 3 for wire connections.
- Attach the Ceiling Canopy (A), the Flat Washer (F) and one Lock Washer (BB) over the end of the Nipple (DD) as shown. Secure by threading the Hex Coupling (H) onto the Nipple (DD) and tighten until snug.



Hardware Contents

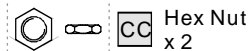

STEP 1 - Install Crossbar

- Attach the Crossbar (AA) to the Outlet Box with the head of the Green Ground Screw facing you. Secure it with Outlet Box Screws (not included). Tighten until snug.

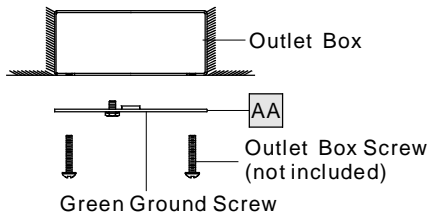

STEP 2 - Install Nipple to Crossbar

* Pliers is required for this step.

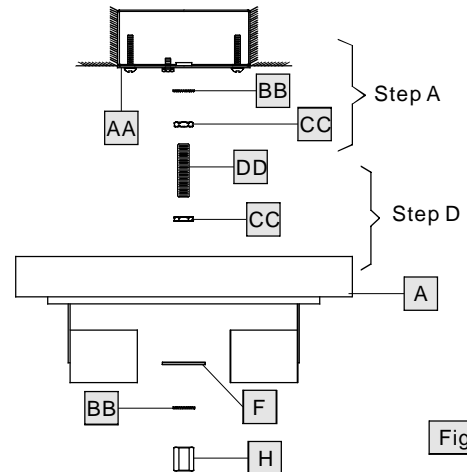

STEP 3 - Wire Connections

- Use standard wire connectors (not included) to make all wire connections. (Connectors are not included with fixture.) Strip and prepare wire ends according to instructions supplied with connectors.
- Connect White Supply Wire from the Outlet Box to Ribbed side Wire from fixture.

Thank you for purchasing a Quoizel product.
Need assistance with parts or assembly? Call Quoizel customer service at 1-631-273-2700
or visit us on-line at www. quozel. com

HC1612IB

FINISH: IMPERIAL BRONZE

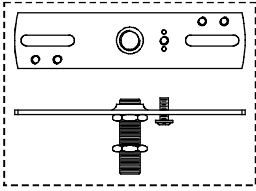

ONE LIGHT SHOWN FOR ILLUSTRATION PURPOSE ONLY.

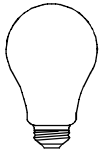
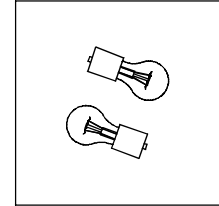
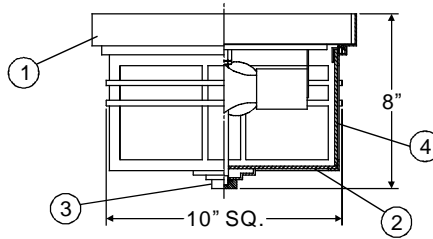

(2) 60W Medium Base Bulbs (Not Supplied)

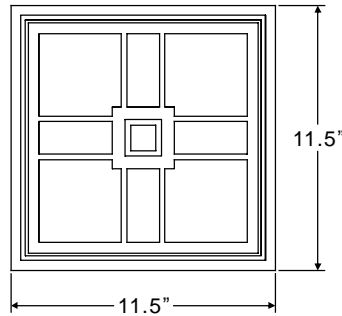

NOTE: ALL DIMENSIONS ARE ROUNDED UP TO THE NEAREST 1/2"

NO.	PART NUMBER	REPLACEMENT PART DESCRIPTION	REQ.
1	11612IBH	BASE IMPERIAL BRONZE FLUSHMOUNT	1
2	G1422PA	BOTTOM PANEL 9-3/4" SQ X 3/8"D	1
3	M1033FIIB	FINIAL IMPERIAL BRONZE 0.37" H X 1.12"	1
4	G1421PA	SIDE PANEL 5-1/8"H X 9-3/4"	4

- C. Connect Black (or Red) Supply Wire from the Outlet Box to Smooth side Wire from fixture.
- D. Connect Ground Wire from the Outlet Box to Ground Wire from fixture.
- E. Twist connectors until wires are tightly joined together.
- F. Wrap each connection with approved electrical tape and carefully stuff all the connected wires into the Outlet Box.

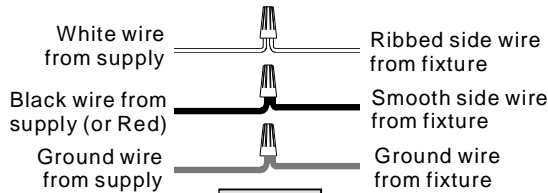

Figure 3

STEP 4 - Install Stem with Hex Nut

- A. Thread the Hex Nut end of the Stem (I) into the Hex Coupling (H). By using pliers, thread the Hex Nut against the Hex Coupling (H) and hand tighten until snug.

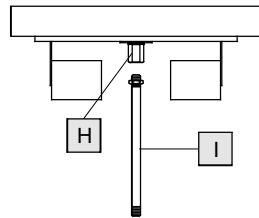

Figure 4

STEP 5 - Install Bulb

- A. This fixture uses standard bulb with medium base. Maximum 60 watts.
- B. Insert bulb and screw snugly into place.

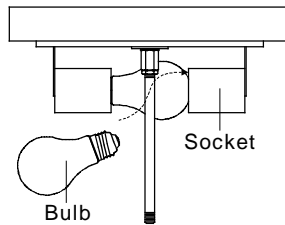

Figure 5

STEP 6 - Install Glass Panels

- A. Insert the Glass Panels (C) into the Cage (B). Attach the Tabs (E) to the top edge of the Glass Panels (C) and secure with the Lock Screws (D). Hand tighten until snug.

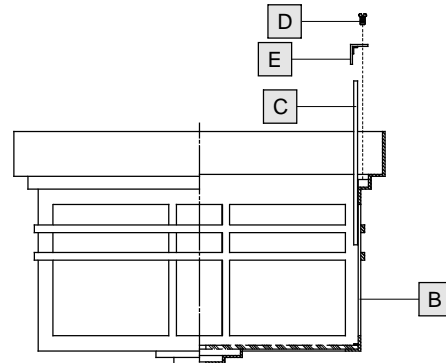

Figure 6

STEP 7 - Install Cage

- A. Place the Cage (B) over the end of the Stem (I) and secure with the Knurled Nut (J). Hand tighten until snug.
- B. Thread the Finial (K) onto the end of the Stem (I) and hand tighten until snug.

Your fixture is now assembled and ready to use. Enjoy!

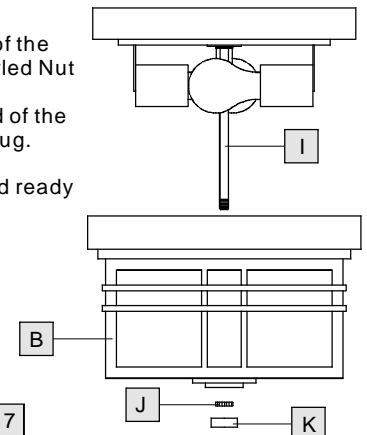

Figure 7

Thank you for purchasing a Quoizel product.
 Need assistance with parts or assembly? Call Quoizel customer service at 1-631-273-2700
 or visit us on-line at www.quoise.com