

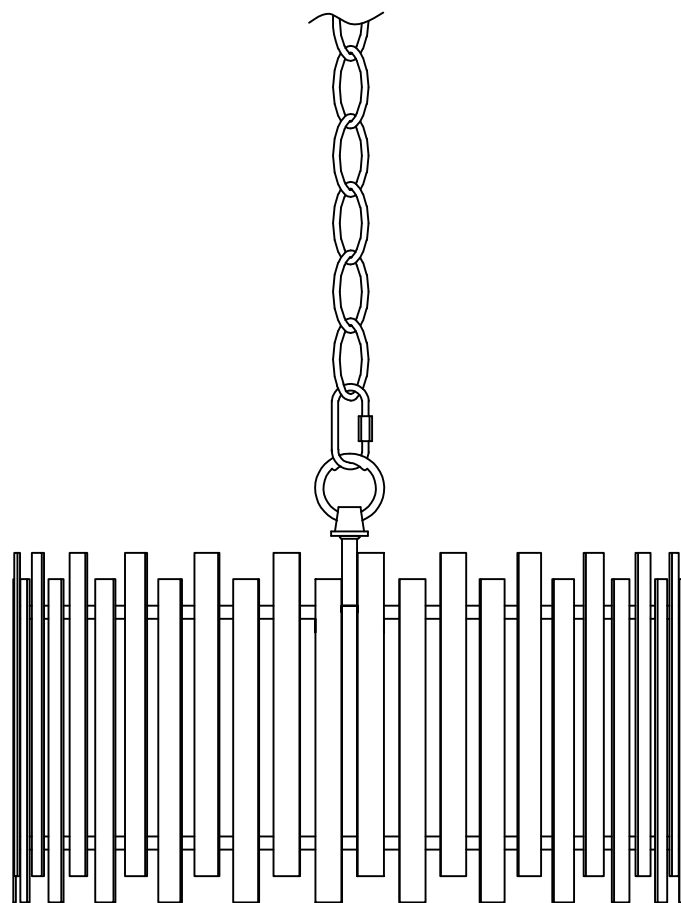

ALL • TOGETHER • BETTER

USE AND CARE GUIDE

PICKET 4 LIGHT PENDANT-#93786



Questions, problems, missing parts? Before returning to the store,
call Kenroy Home Customer Service
8 a.m.-6 p.m., EST, Monday-Friday

904-642-4340

THANK YOU

We appreciate the trust and confidence you have placed in Kenroy Home through the purchase of this item.
We strive to continually create quality products designed to enhance your home.
Thank you for choosing us!

Table of Contents

Safety Information	2
Warranty	2
Pre-Installation	3
Planning Installation	3
Package Contents	3
Assembly	4
Installation	4, 5, 6
Care and Cleaning	7
Troubleshooting	7

Safety Information

- Consult a qualified electrician with any electrical questions you may have.



IMPORTANT: Inspect the wire insulation for any cuts, abrasions, or exposed copper that may have occurred during shipping. If there is a defect in the wire, do not continue the assembly process. Please call our Customer Service Team at 904-642-4340.

Warranty

1-YEAR LIMITED WARRANTY

WHAT IS COVERED

The manufacturer warrants this chandelier to be free from defects in the materials and workmanship for a period of one (1) year from date of purchase. This warranty applies only to the original consumer purchaser and only to products used in normal use. If this product is found to be defective, the manufacturer's only obligation, and your exclusive remedy, is the repair or replacement of the product at the manufacturer's discretion, provided that the product has not been damaged through misuse, abuse, accident, modifications, alterations, neglect or mishandling. This warranty shall not apply to any product that is found to have been improperly installed, assembled, or used in any way not in accordance with the instructions supplied with the product. This warranty shall not apply to a failure of the product as a result of an accident, misuse, abuse, negligence, alteration, faulty installation, or any other failure not relating to faulty material or workmanship.

WHAT IS NOT COVERED

This warranty shall not apply to the finish on any portion of the product due to weathering, as this is considered normal wear. The manufacturer does not warrant and specifically disclaims any warranty, whether expressed or implied, other than the warranty contained herein. The manufacturer specifically disclaims any liability and shall not be liable for any consequential or incidental loss or damage, including but not limited to, any labor or expense costs involved in the replacement or repair of the product.

Contact the Customer Service Team at 904-642-4340.

Pre-Installation

PLANNING INSTALLATION

Read all instructions before assembly.

To avoid damaging this product, assemble it on a soft, non-abrasive surface such as carpet or cardboard. Inspect each part for defects that may have occurred during shipping.

Keep your receipt and these instructions for proof of purchase.

 NOTE: This chandelier requires the use of four 120V, 60Hz, 60-Watt max, candelabra-base type B bulbs (not included). Do not exceed the recommended wattage.

TOOLS REQUIRED

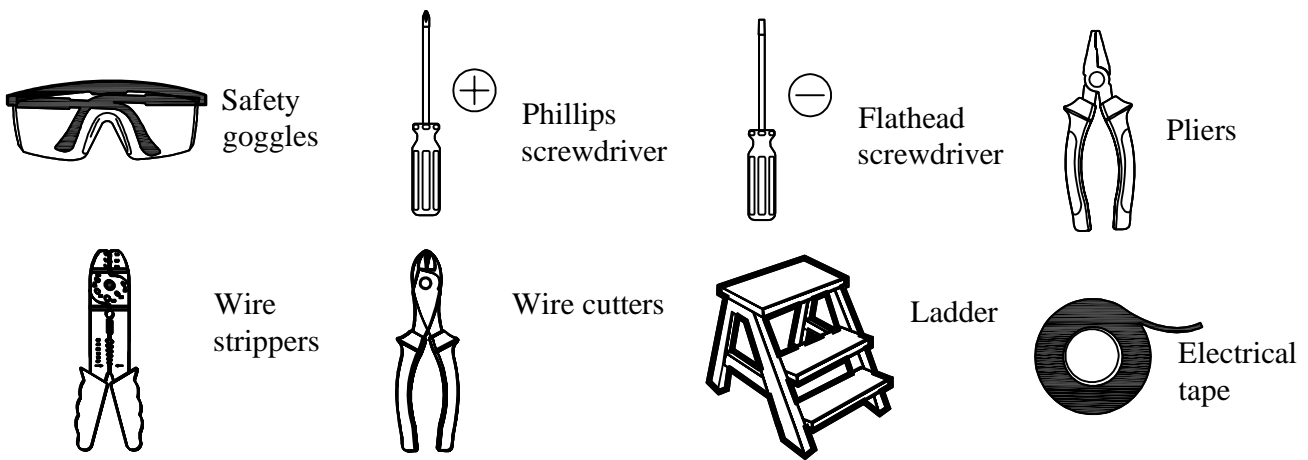

HARDWARE INCLUDED

 NOTE: Hardware not shown to actual size.

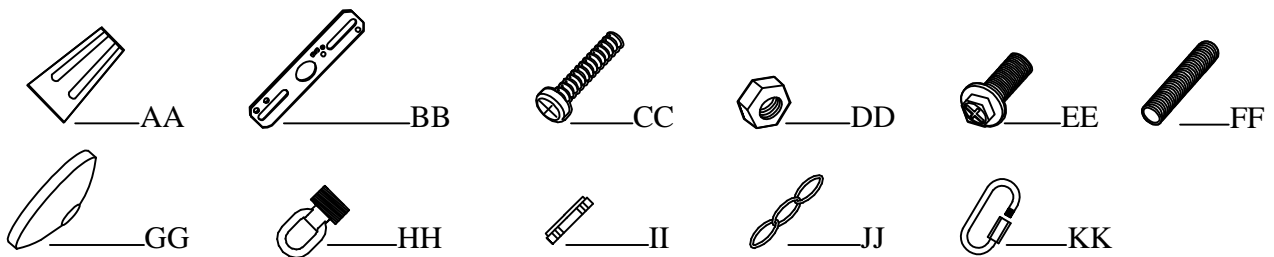

Part	Description	Quantity	Part	Description	Quantity
AA	Wire nut	3	GG	Canopy	1
BB	Cross bar	1	HH	Screw Collar Loop	1
CC	Outlet box screw	2	II	Screw Collar Nut	1
DD	Lock nut	1	JJ	Chain	1
EE	Ground screw	1	KK	Quick link	2
FF	Nipple	1			

Pre-Installation (continued)

PACKAGE CONTENTS

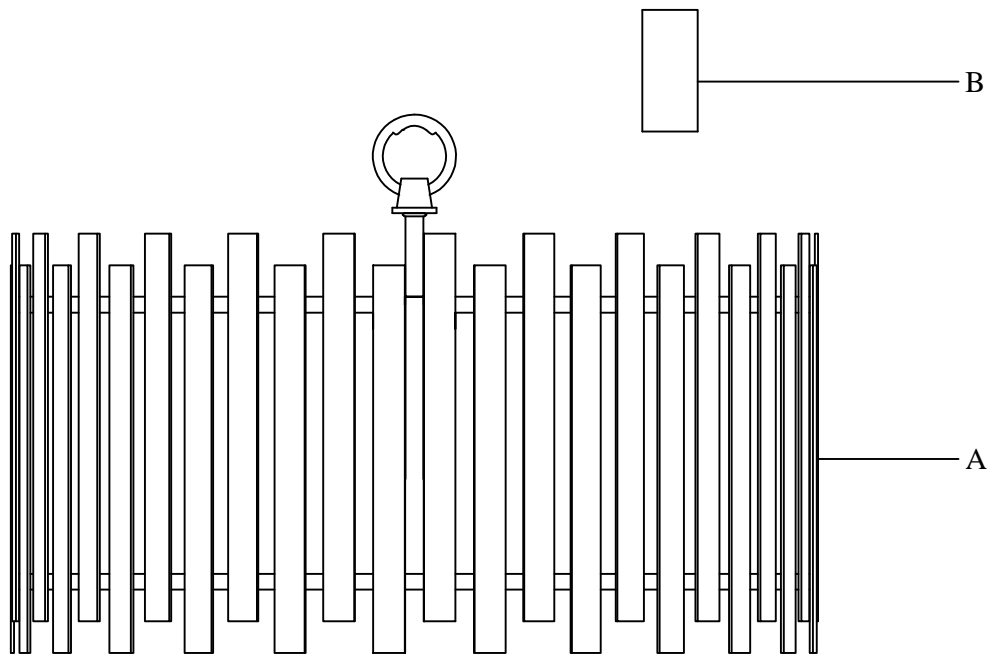

Part	Description	Quantity
A	Fixture body	1
B	Candle sleeve	4

Assembly instructions

1 Preparing the light fixture to hang

- Carefully unpack the fixture, lay out all parts on clean surface.
- Attach the quick link (KK) to one end link of chain (JJ) and attach the quick link (KK) to the chain loop.
- Remove chain links from the chain (JJ) in order to achieve the desired length for hanging the fixture .
- Thread the fixture and bar copper or silver ground wires up through every other link in the chain (JJ).

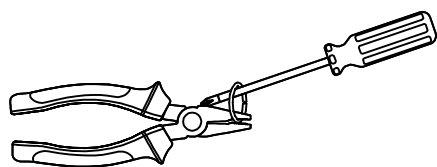
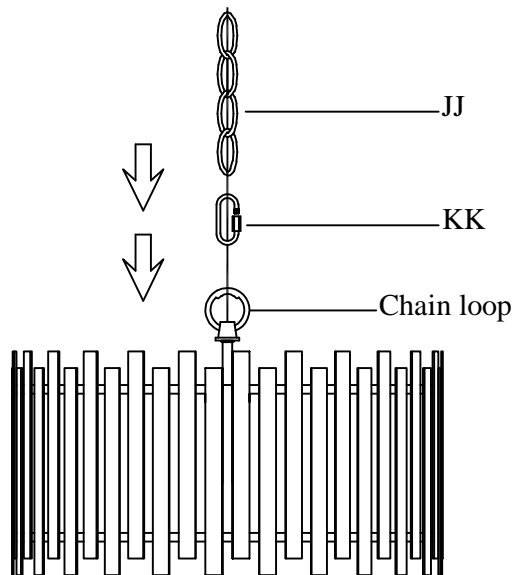

To open a chain link: Use a pair of pliers and a screwdriver as shown above to open a chain link. Wrap the jaws of the pliers with cloth to protect the finish of the chain.

Installation instructions

1 Installing the cross bar



CAUTION: Ensure the power is off at the main fuse box prior to beginning installation.

- Turn off the switch at the wall.
- Turn the power off at the main fuse box.
- Install the cross bar (BB) with nipple (FF), lock nut (DD) to the outlet box using two outlet box screws (CC).
- Unscrew the screw collar nut (II) from the screw collar loop (HH).
- Slide the screw collar nut (II) and then the canopy (GG) onto the end of the chain (JJ).
- Attach the quick link (KK) to end of the chain (JJ) and attach the quick link (KK) to the screw collar loop (HH).
- Insert the fixture wires up through the nipple (FF).

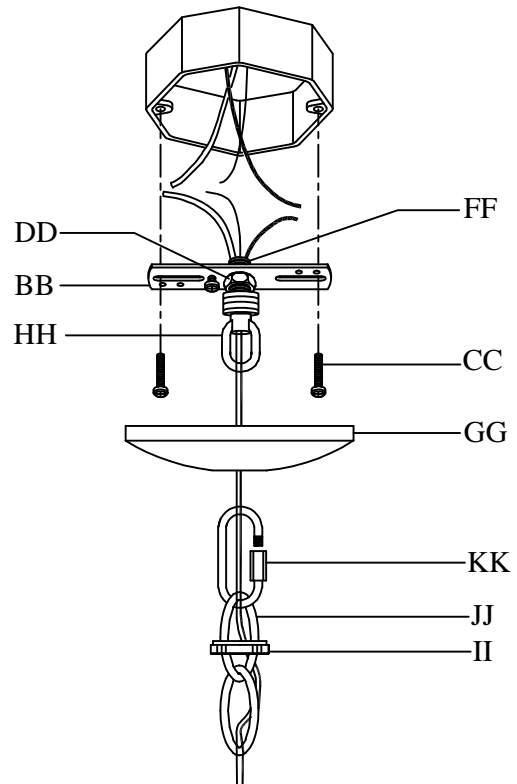

Installation instructions (continued)

2 Connecting the wires

- Install the fixture bare copper ground wire (1) under the ground screw (EE) on the crossbar (BB).
- Connect the fixture bare copper ground wire (1) to the green (or bare, or green & yellow) supply ground wire (2) in the outlet box using a wire nut (AA).
- Connect the ribbed fixture wire (3) to the white (or ribbed) supply wire (4) in the outlet box using a wire nut (AA).
- Connect the smooth fixture wire (5) to the black (or red, or blue) supply wire (6) in the outlet box using a wire nut (AA).

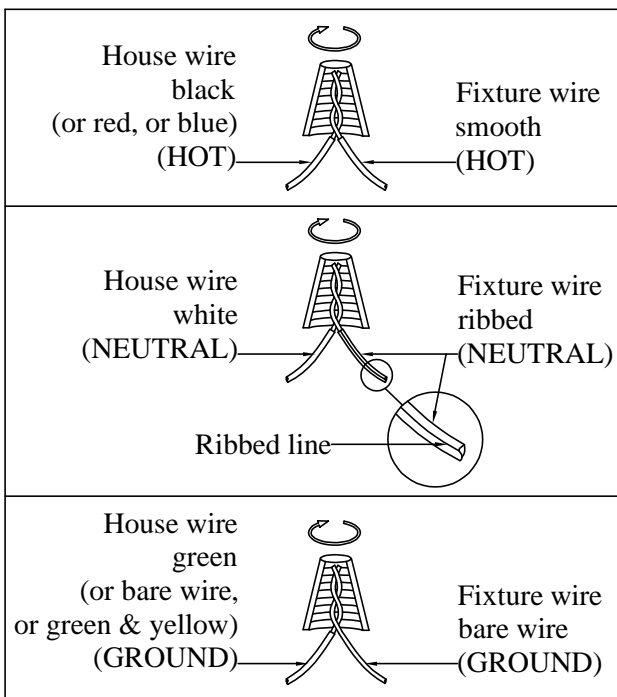
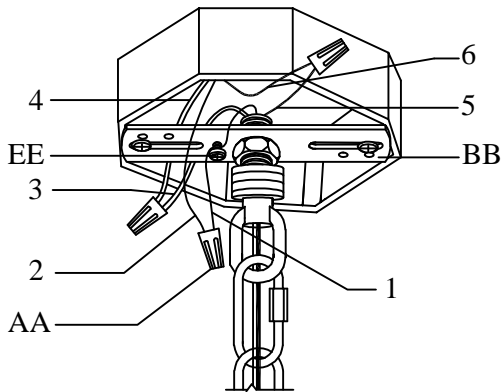

3 Hanging the light fixture

- Push all excess wires into the outlet box.
- Raise the canopy (GG) to the ceiling and secure in place by screwing the screw collar nut (II) onto the screw collar loop (HH).

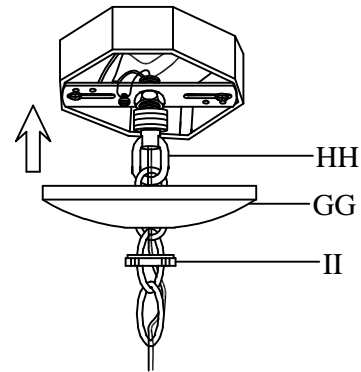

4 Installing the bulbs

- Slide four candle sleeve (B) over the sockets.
- Prior to installing the bulbs, inspect the socket for silica packet. If packet is present, then remove and throw away. Do not expose it to children or pets.
- Install one 120V, 60Hz, 60-watt max. candelabra-base type B bulb (not included) into each socket on the fixture.

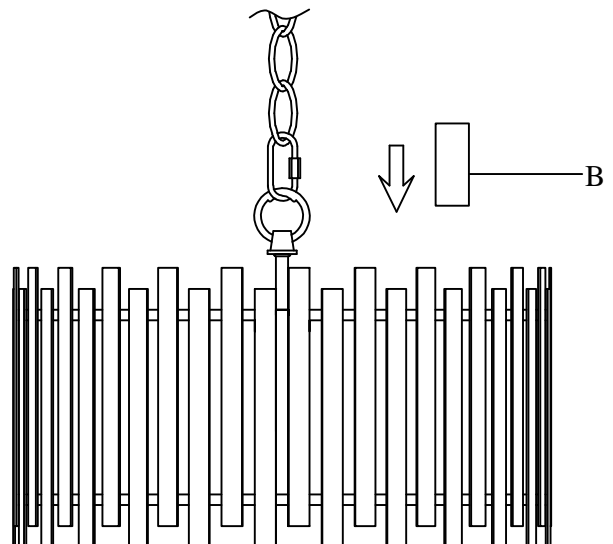

Care and Cleaning

Clean the light fixture with a soft, dry cloth. Do not use any cleaners with chemicals, solvents, or harsh abrasives.

Troubleshooting

Problem	Possible Cause	Solution
The bulb will not light.	<input type="checkbox"/> The bulb is burned out.	<input type="checkbox"/> Replace the light bulb.
	<input type="checkbox"/> The power is off.	<input type="checkbox"/> Ensure that the power supply is turned on.
	<input type="checkbox"/> There is a faulty wire connection.	<input type="checkbox"/> Check the wiring.
	<input type="checkbox"/> The circuit breaker is off.	<input type="checkbox"/> Ensure that the circuit breaker is set in the on position.
The fuse blows or a circuit breaker trips when the light is turned on.	<input type="checkbox"/> There is an exposed wire. <input type="checkbox"/> There are too many items on one circuit.	<input type="checkbox"/> Discontinue use of the light fixture. <input type="checkbox"/> Contact a qualified electrician or call the Customer Service Team at 904-642-4340. <input type="checkbox"/> Unplug other items on the circuit.



ALL • TOGETHER • BETTER



www.kenroyhome.com

CUSTOMER SUPPORT TEAM

For any additional questions or concerns please contact our Customer Support Team:

 **904-642-4340**

 **@KenroyHome**

 **customerorders@kenroyhome.com**