

ASSEMBLY AND INSTALLATION INSTRUCTIONS

P0380

WARNING: TO AVOID RISK OF ELECTRICAL SHOCK, BE SURE TO SHUT OFF POWER WHILE INSTALLING OR SERVICING THIS FIXTURE.

NOTES: 1. Before installing, consult local electrical codes for wiring and grounding requirements.
2. Read and save this instruction.

Hardware Package (included):

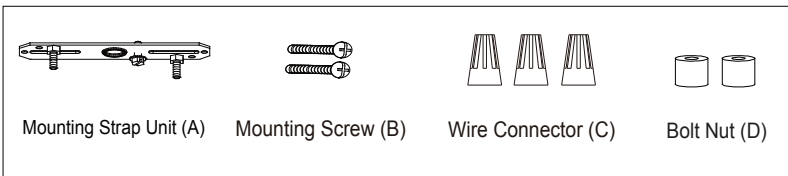

Installation Steps

Turn off the power at fuse or circuit box.

1. Rod Connections:
 - a. Thread the fixture wire from the fixture through the lower rod, then secure the lower rod onto fixture using the threaded pipe.
 - b. Thread the fixture wire through the middle rod, and then secure the middle rod onto the lower rod using the threaded pipe.
 - c. Thread the fixture wire through the upper rod, and then secure the upper rod onto the middle rod using the threaded pipe.

Note: Length adjustable from 17" to 59". Use fewer rods if shorter length is desired.
2. Thread the fixture wire through the canopy kit, then secure the rod assembly to the set threaded pipe of the canopy kit.
3. Attach the mounting strap unit (A) to outlet box by using two mounting screws (B).
4. Pull out the source wires from the outlet box. Make wire connections using wire connectors (C) as follows:
 - Connect the smooth-coated wire (marked) from the fixture to the black wire from the power source.
 - Connect the ribbed-coated wire (unmarked) from the fixture to the white wire from the power source.
 - Attach the fixture ground wire to the mounting strap unit (A) with the green ground screw, then connect it to the house ground wire with a wire connector (C).Carefully put the wires back into the outlet box.
5. Attach the canopy kit to the mounting strap unit (A) by inserting the fixture mounting screws, then secure it with two bolt nuts (D).
6. Attach the glass shade to fixture, then secure it with the socket ring.

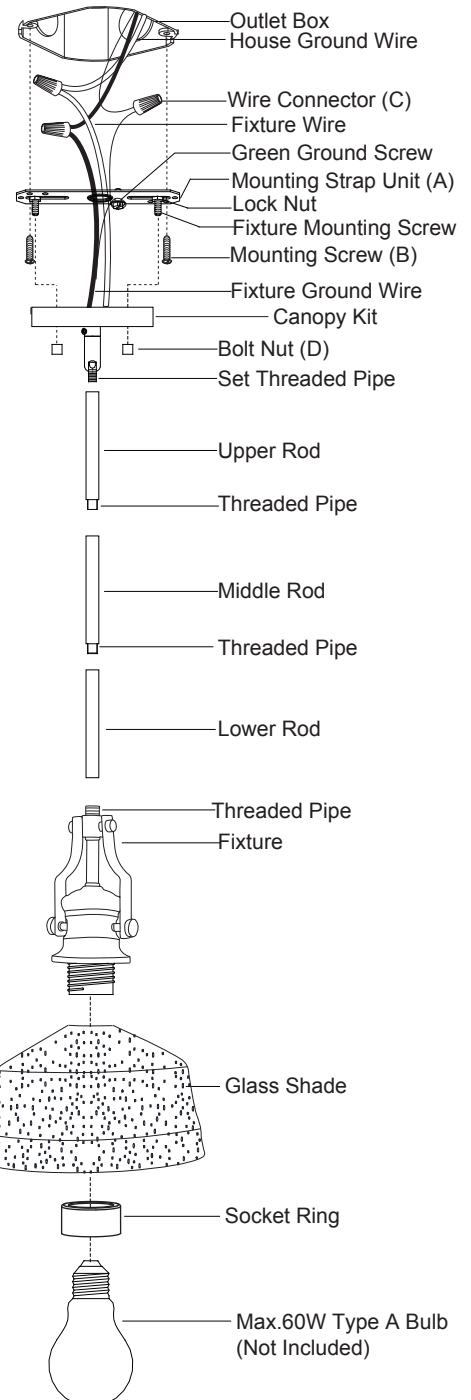

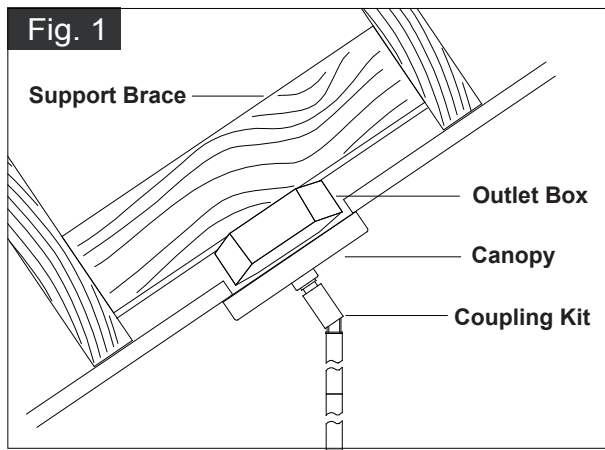

7. Install 1 X 60W Max. medium base bulb (not included). See relamping label at socket area or packaging for maximum wattage allowed.
8. Angled mounting recommended for a vaulted or angled ceiling. (See Fig.1)

Turn on the power at fuse or circuit box.

The following parts are available for reorder if damaged or missing.

Spare Parts List:

				→ Mounting Hardware 6519MM (1 SET)
Mounting Strap Unit (A)	Mounting Screw (B)	Wire Connector (C)	Bolt Nut (D)	

12" Rod 3336RD	6" Rod 3337RD	3" Rod 3338RD	Glass Shade 10029CS

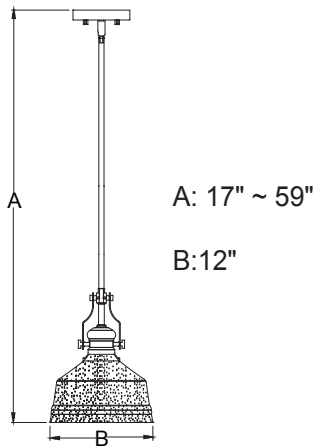

1 Year Warranty

Vaxcel warrants all of our products against defects in workmanship and finishes for one year following the date of shipment.

Exclusions: This warranty does not include the failure of products from extreme acts of nature; environmental conditions not suited for the products intended use; operation in temperatures outside of the range specified in the instruction manual; usage with improper power supply, power surges or dips. For coastal locations, some corrosion is considered normal for the environment.

Vaxcel reserves the right to repair, replace or issue a credit for any properly installed product, provided it is returned per RMA instruction. This warranty is limited to the cost of the product only and does not extend to transportation, installation or replacement costs.

How can warranty service be obtained?
 info@vaxcel.com
 1-800-482-9235