

# ASSEMBLY INSTRUCTIONS

MODEL# : E21254-20PC

**NOTE:** Only the technical personnel can be allow to fix and maintain.

## IMPORTANT!

Make sure that the power is switch off at the electricity mains supply before commencing work.

## FIXING INSTRUCTIONS

1. Remove the mounting bracket (C) from the canopy (E).
1. Remove the mounting bracket (C) from the canopy (E).
2. Mount ground wire on mounting bracket (C) onto ground screw in the junction box (A). Firmly connect the mains supply wires to the light fitting using the connectors provided (B). Ensure that wires are secure and that no bare wire is exposed.
3. Install the mounting bracket (C) to the junction box (A) using the screws (D).
4. Install the canopy (F) to the mounting bracket (C), tighten it using the securing screws (D).
5. Install the crystal(H) to lighting frame.
6. Fit the bulbs into each socket (G) . Do not use bare hands to install. Use a tissue otherwise life of lamp will decrease drastically.
7. Turn on the power, enjoy your new lighting product.

## REPLACEMENT BULB

Do not exceed the maximum wattage.

Light bulbs recommended:

E21254-20PC - 6x Max. 60W 120V G9

## CLEANING CARE

Clean with a soft dry cloth.

## SAFETY INFORMATION

- 1.Lamp used must in rated voltage ,and do not touch the bulb with bare hands. Always switch off the electricity supply and allow to cool for 10 minutes before changing the light bulbs.
2. If the external cables have been damaged,Pls change or repair by manufacturer or service agency or professional electrician,In order to avoid the danger.

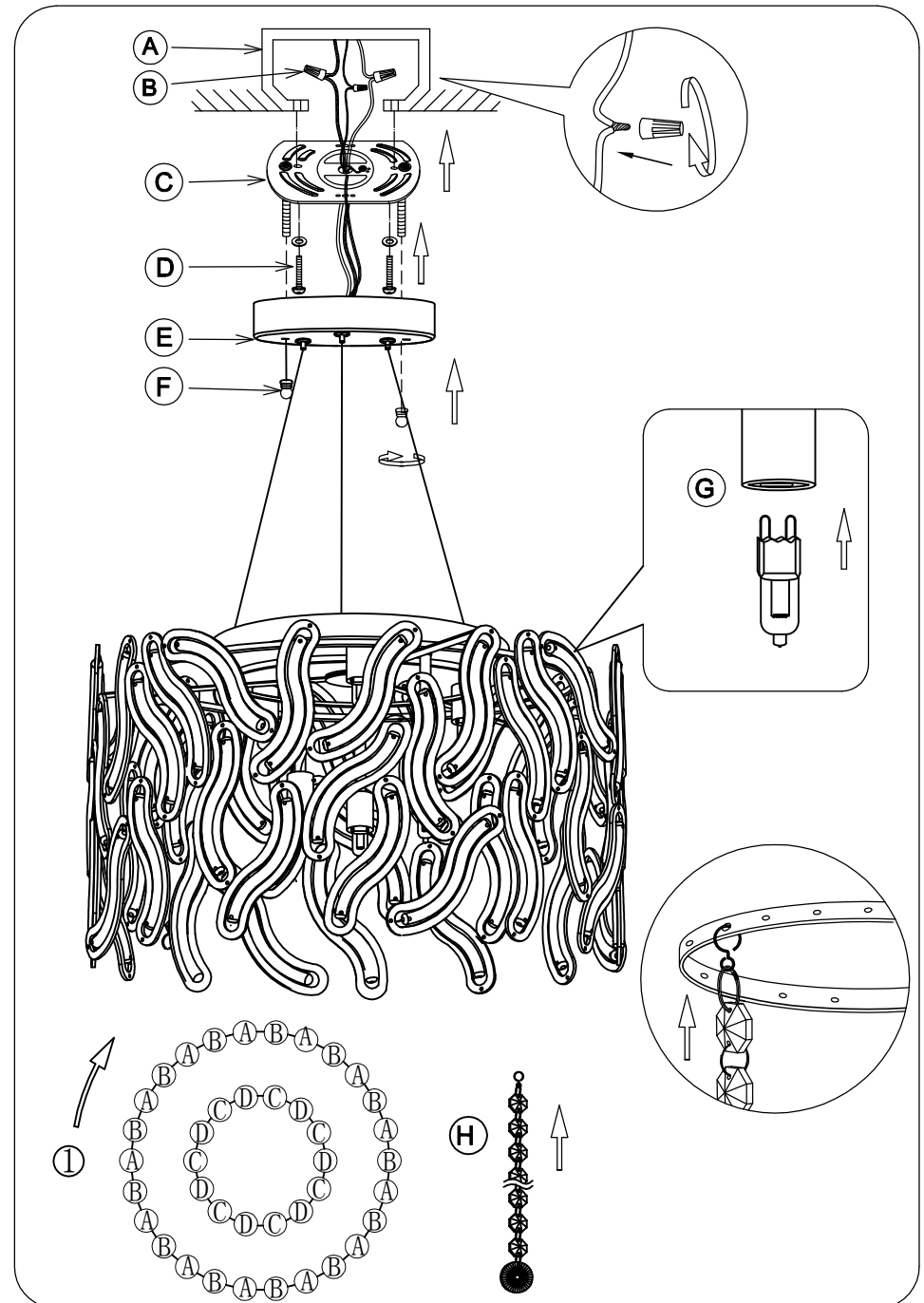

crystal Assembly Instruction:

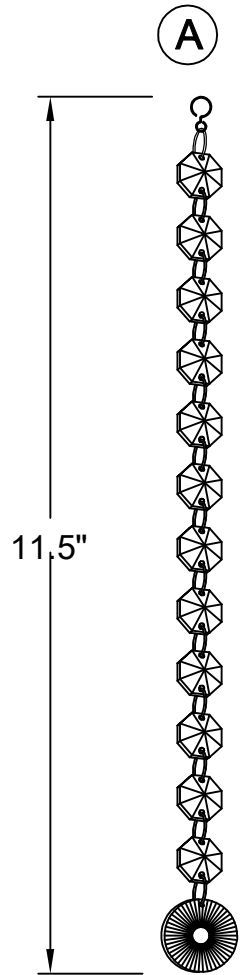

13PCS

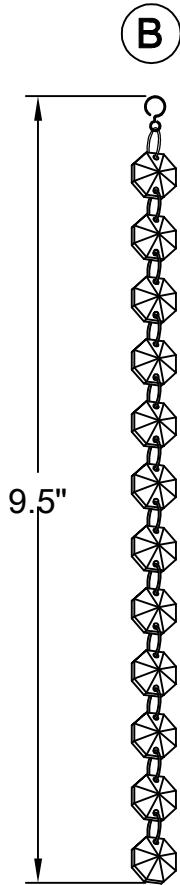

13PCS

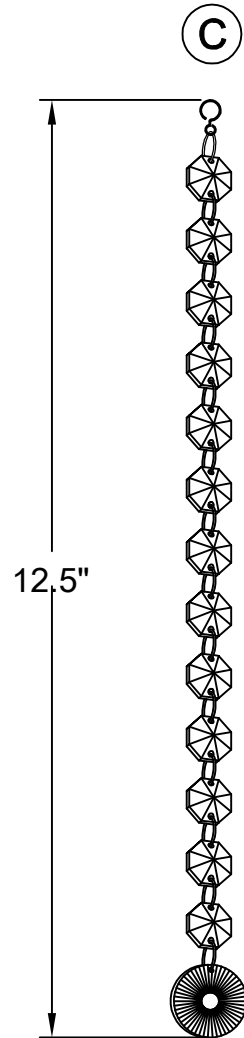

7PCS

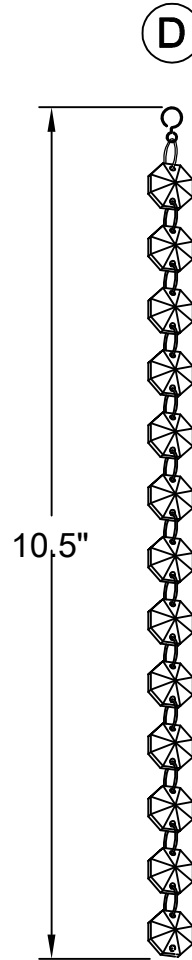

7PCS

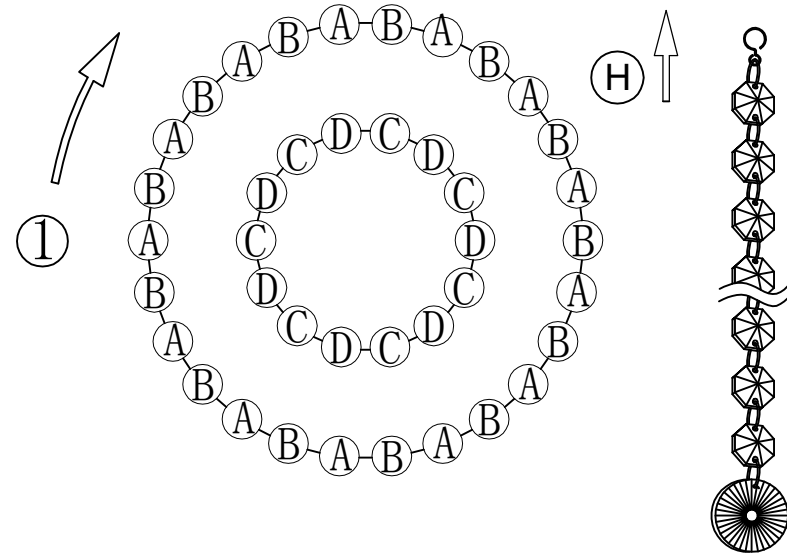
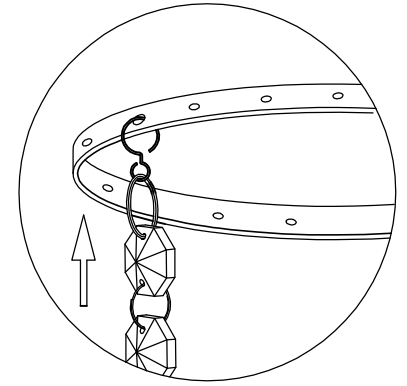

CRY Code	MAXIM CRY#	CRY Code	MAXIM CRY#
A	ECRY21250-F	D	ECRY21250-G
B	ECRY21250-E		
C	ECRY21250-H		