

LED Flush Mount

FM48618-5CCT

INSTALLATION SHEET

START FROM HERE

- Make sure **POWER** is **COMPLETELY OFF** at the fuse box
- Have your fixture installed by a qualified licensed electrician
- Prepare everything in a clear area
- Wear gloves at all time during this installation
- Read instructions carefully before you start assembly
- Keep this installation sheet for future reference

Please Note:

- This Kuzco LED fixture comes with pre-wired LED module(s)
- Unless instructed, Do Not touch any part of the LED module(s) as any unnecessary contact with the module could cause permanent damage
- Use ELV (Electronic Low Voltage) type of dimmer for dimming application
- 120V input

Technical Support: 1-855-855-8926

1. Remove fixture from its original package
2. Separate mounting plate (1c) from outer glass (2a) and LED module (2b) by removing decorative nuts (2c)
3. Align mounting plate screws (1d) to desired orientation, and then attach mounting plate (1c) to electrical junction box (1a) using junction box screws provided (1e) in hardware package
4. Make proper electrical connections (black to hot "L", white to neutral "N", ground to "GND") with wire nuts (1b) provided in hardware package
5. Align and insert mounting plate screws (1d) through holes on glass (2a) and LED module (2b), secure with decorative nuts (2c)
6. Choose color temperature by using slider (5a)
7. Attach diffuser (2d) to LED module (2b) by turning clockwise to secure

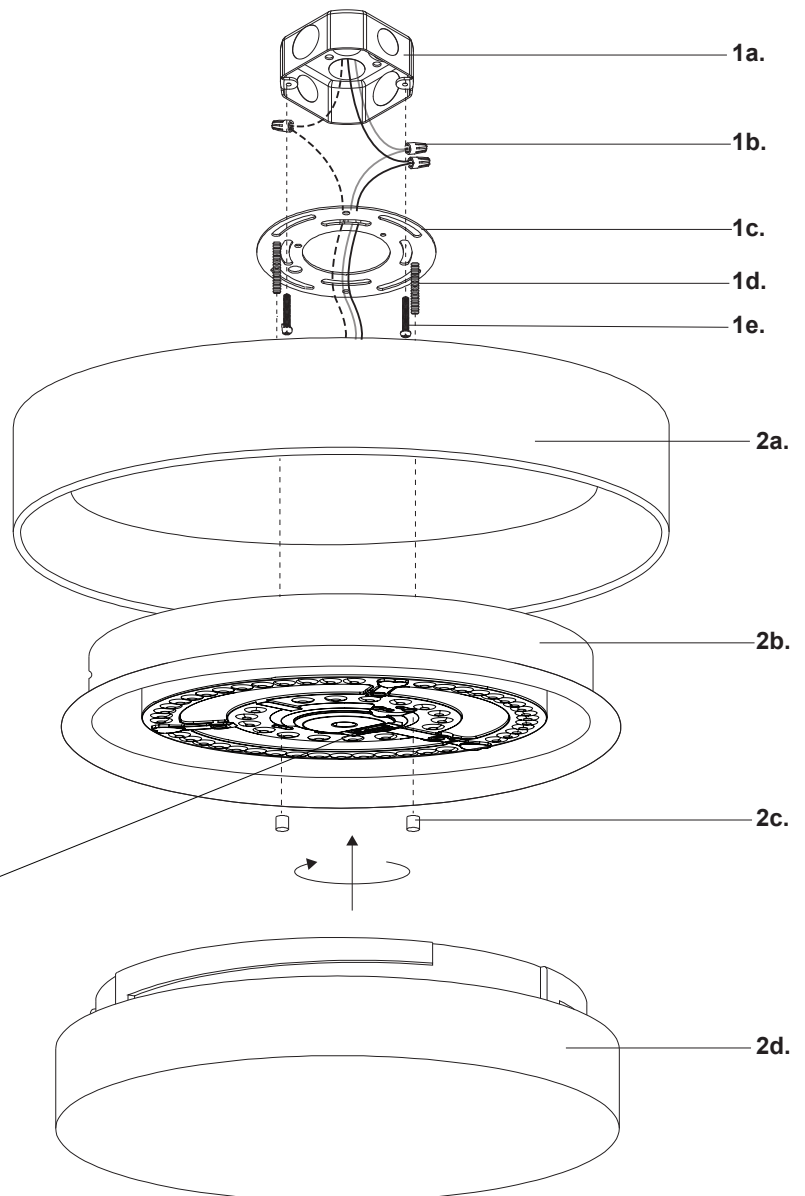

KUZCO

19054 28th Avenue Surrey, BC Canada V3Z 6M3
T: 604 538 7162 TF: 1-855 85 KUZCO F: 604 538 7196
W: kuzcolighting.com
20230926