

Trade Mark:
CRYSTAL WORLD INC

Product Name: Ceiling lamp
Model :8002C16C
120Vac, 60Hz,AC ONLY
Lamp size:Ø16"XH9"

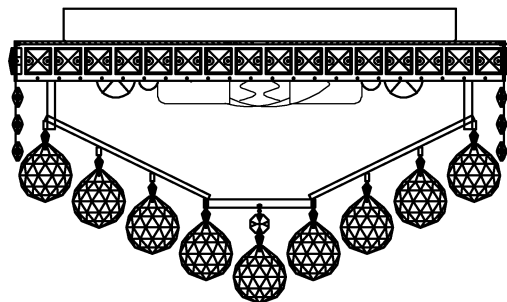

Intertek
4006677

CEILING LAMP ASSEMBLY INSTRUCTIONS

1.Place fixture(A) onto mounting screws (DD),secure with cap nuts (AA).

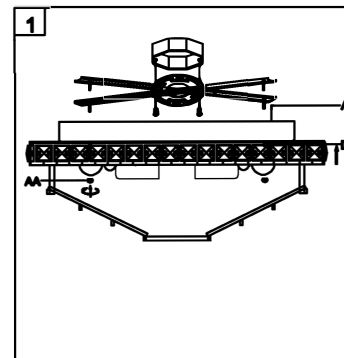



Hardware Used

AA Cap nut  X 4

DD Mounting screw  X 4

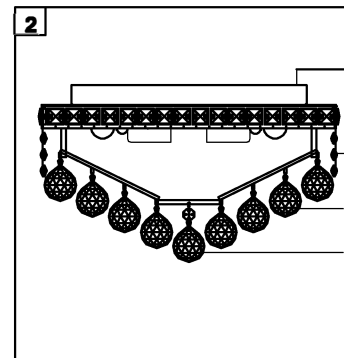
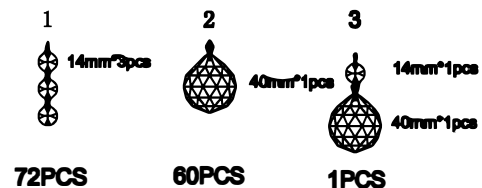
2.Please put the crystal(1) (2) (3) to the fixture (A) .



3.Install light bulbs (not included).
Use bulb
120V E12  5*40W Max.

