









# Assembly Instruction Sheet #IS-1125P39-17 For Style 1125P39-17

**Tools Required:** Flathead screwdriver, Phillips screwdriver, pliers, wire cutters, wire strippers, electrical tape, safety glasses.  
**Light Source:** (17) unincandescent LED or CFL max. 60W (Not Included).  
**Estimated Assembly Time:** 16-30 minutes.  
**Preparation:** Identify and inspect all parts before beginning installation. Check package content list and diagrams below to be sure all parts are present. If any parts are missing or damaged, do not attempt to assemble, install, or operate the fixture. Contact customer service for replacement parts.

**Warnings and Cautions**  
 Turn off electricity at circuit breaker or main fuse box before installation. Consult a licensed electrician if in doubt. These instructions are provided for your safety. It is very important you read them completely before installing the fixture. We strongly recommend that a licensed, professional electrician perform the installation. Disconnect fixture from power source before replacing bulbs. Make sure bulbs are given sufficient time to cool before removal.

**Package Contents**

 B1 Middle Rod	 A Fixture Body x1
 B2 6 1/4"pos	 C Glass Shade x17
 B3 12"pos	 D Metal Ball Ø60 x8
	 E Metal Ball Ø50 x8
	 F Nibble 11" x8
	 G Nibble 13" x8

**Hardware Contents**

PART	DESCRIPTION	QUANTITY
AA	Decorative Caps	4pcs
BB	Decorative Caps	2pcs
CC	Outlet Box Screws	2pcs
DD	Mounting Screws	2pcs
EE	Mounting Screws	2pcs
FF	Lock Washers	2pcs
GG	Lock Washers	2pcs

**STEP 1 - Install Rods to Fixture Body**  
 A. Thread the power cord to the Middle Rods. Fix the Middle Rods with the fixture body then the same to connect the other pieces of Rods. Finally fix the Canopy with the Rods.

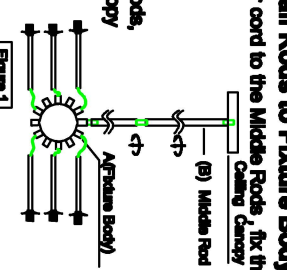

Figure 1

**STEP 2 - Attach Mounting bracket to Outlet Box**  
 A. Pass the supply wires through the Mounting bracket (EE). Attach the Mounting bracket (EE) to the Outlet Box with the head of the Green Ground Screw facing you. Secure K Screws (CC). Tighten until snug.

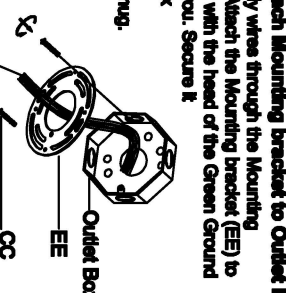

Figure 2

**STEP 3 - Fit Ceiling Canopy to Mounting bracket Assembly**  
 A. Fit the Ceiling Canopy to Mounting Screws (DD) and secure with Decorative Caps (AA). Note: The Ceiling Canopy should fit snug against the ceiling and the Decorative Caps (AA). If not, adjust the length of the Mounting Screws (DD) by unscrewing the Hex Nut and Lock Washer and then screwing Mounting Screws (DD) in or out of the Mounting bracket (EE) until the correct length is achieved. Once the Ceiling Canopy is secure, remove the Decorative Caps (AA) and Ceiling Canopy and proceed to Step 4.

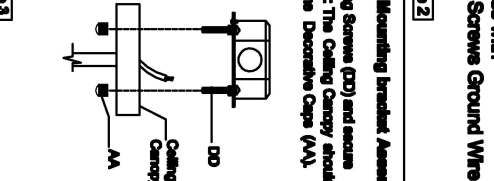

Figure 3

**STEP 4 - Wire Connections**  
 A. Use standard wire connectors to make all wire connections. Twist connectors until wires are tightly joined together. Wrap each connection with approved electrical tape and carefully strip all the connected wires into the Outlet Box.

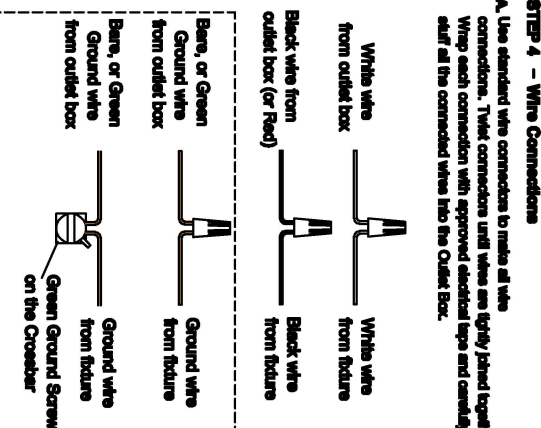

Figure 4

**STEP 5 - Install Ceiling Canopy to Ceiling**  
 A. Carefully tuck all wires into the outlet box and position the Ceiling Canopy of the Fixture Body (A) over the outlet box. Align the holes in the Ceiling Canopy with the Mounting Screws (DD). Secure with Decorative Caps (AA) and hand tighten until snug.

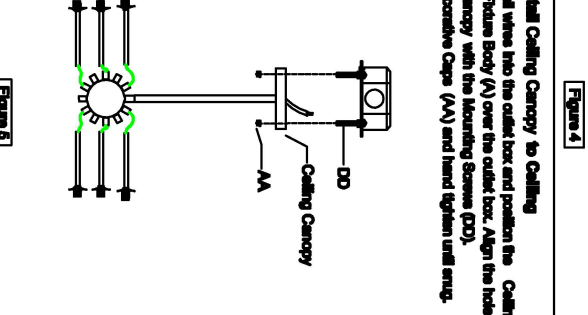

Figure 5

**STEP 6 - Install bulb and Glass Shade, Metal Ball.**  
 A. Color all the extra wire and put them into the ball then lock the arms with the ball one by one and fix them with screw.  
 B. Install bulbs (Not Included) into sockets and screw snug into place.  
 C. Please put the Glass Shade, Metal Ball to the Fixture Body (A).

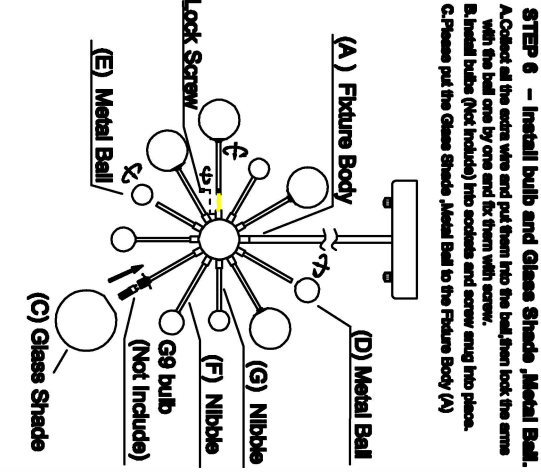







Figure 6

**Hardware Contents**

 C Glass Shade x17	 D Metal Ball Ø60 x8
 E Metal Ball Ø50 x8	 F Nibble 11" x8
 G Nibble 13" x8	

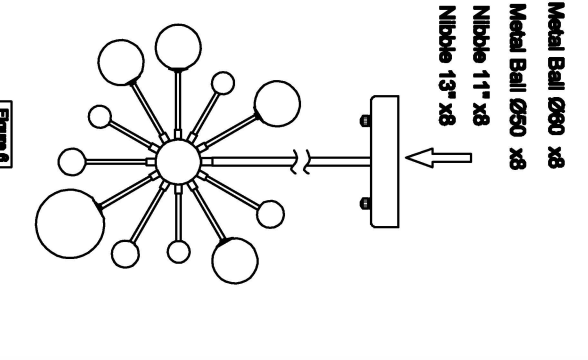

Figure 8