

ITEM: 471-2W

DESIGN COPYRIGHT – 11/18/2022
ALL RIGHTS RESERVED AND MAY
NOT BE DUPLICATED WITHOUT OUR
WRITTEN PERMISSION

G471-12

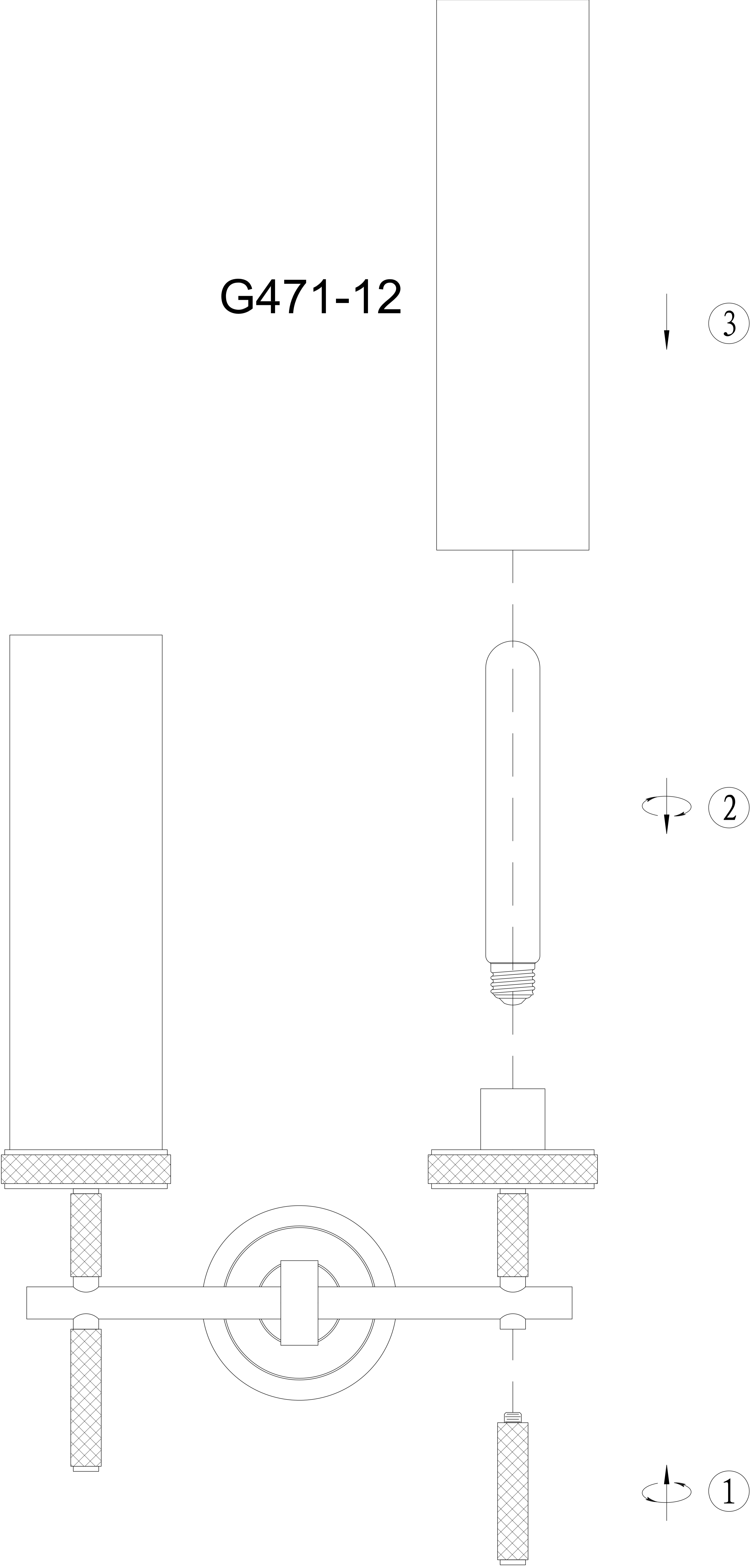

STANDARD MOUNTING PLATE INSTALLATION INSTRUCTIONS

FOR YOUR SAFETY WARNING

Risk of Fire, Consult a qualified electrician to ensure correct branch circuit conductor.

Turn off the main power at the circuit breaker before installing the fixture in order to prevent possible shock.

General

All electrical connections must be in accordance with local and National Electrical Code (N.E.C.) standards. If you are unfamiliar with proper electrical wiring connections obtain the services of a qualified electrician. Remove the fixture and the mounting package from the box and make sure that no parts are missing by referencing the illustration.

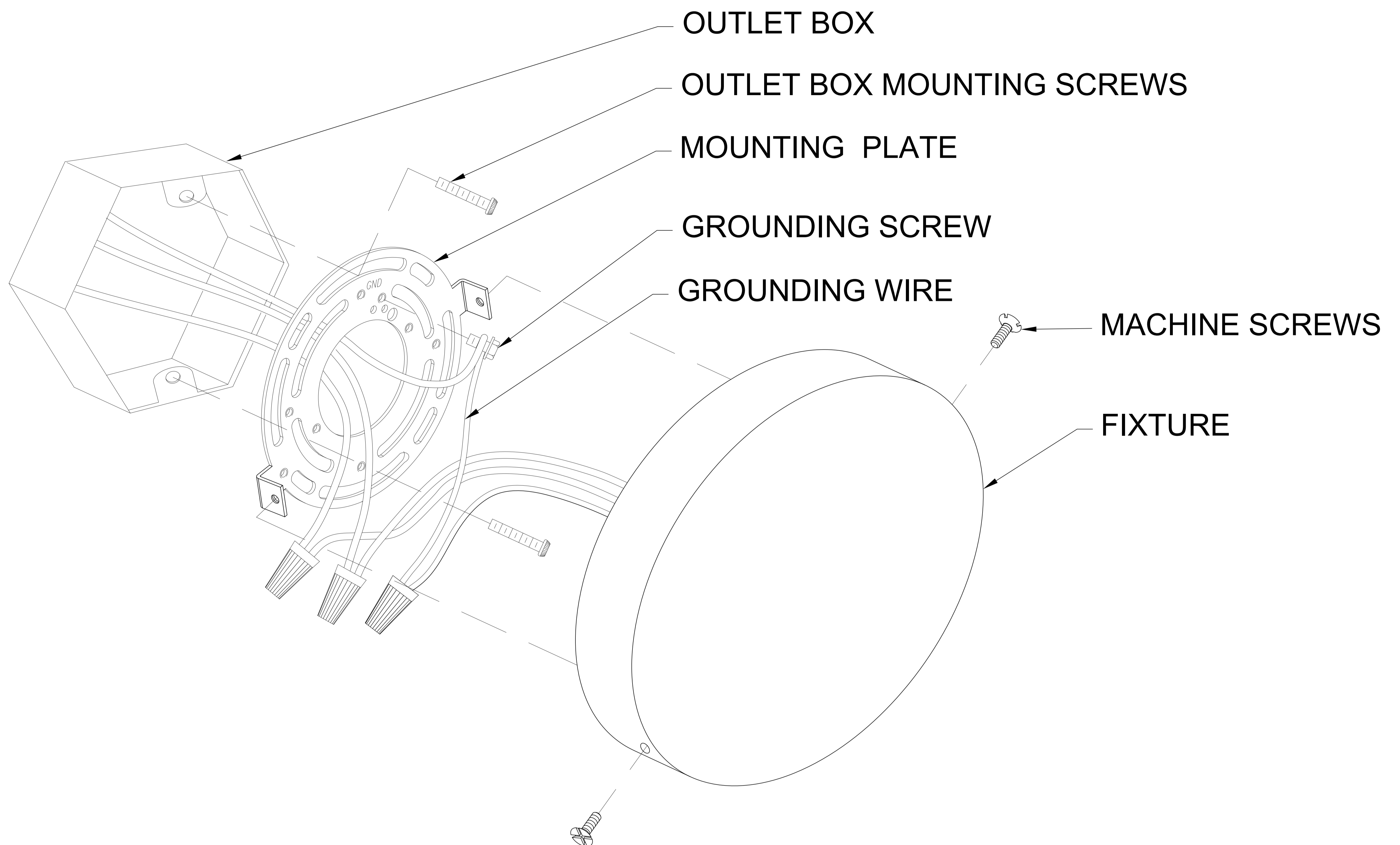

CAUTION: DISCONNECT POWER DURING INSTALLATION

- 1.) If you are replacing an existing fixture, disconnect and remove the old fixture. Expose the supply wiring from the outlet box.
- 2.) Fasten the mounting plate to the outlet box using the two box screws supplied with the outlet box.
- 3.) Spread the electrical wires so that the black wires are on one side of the outlet box and the white wires are on the other side.
- 4.) Grounding instructions:
 - A.) On fixtures where mounting plate is provided with a green ground screw and two raised dimples, Wrap ground wire from outlet box around green ground screw and tighten.
 - B.) On fixtures where mounting plate is provided with a green ground wire attached. Connect mounting plate ground wire to ground wire from outlet box with wire connector(not provided).
- 5.) To make electrical connections: Connect the white wire(s) from the fixture to the white wire of this outlet box. Connect the black wire(s) from the fixture to the black wire of the outlet box. NOTE: Black wire from outlet box may be red, round & smooth and/or have copper conductor. White wire from outlet box may be square & ridged and/or have a silver conductor. After wires are connected, tuck them carefully inside outlet box.
- 6.) Place fixture against mounting surface allowing the machine screws to pass through the fixture backplate. then, secure the machine screws tight.