

MODERN FORMS SMART FANS

F-1811-LED

INSTALLATION INSTRUCTIONS

TABLE OF CONTENTS

1. Safety Rules
2. Package Contents
3. Installation Instructions

1. SAFETY RULES

For operation, maintenance, and troubleshooting information, visit modernforms.com/help.

1. To prevent electrical shock, ensure electricity has been turned off at the circuit breaker before beginning.
2. All wiring must be in accordance with the National Electrical Code "ANSI/NFPA 70" and local electrical codes. Electrical installation should be performed by a licensed electrician.
3. The fan must be mounted with a minimum of 7 ft (2.1 m) clearance from the fan blades to the floor and a minimum of 1.5 ft (0.5 m) from the edge of the fan blades to the surrounding walls.
4. The outlet box and support structure must be securely mounted and capable of reliably supporting a minimum of 35 lbs (15.9 kg). Use only UL/cUL listed outlet boxes marked "FOR FAN SUPPORT" Use only the screws and washers provided with the outlet box.

WARNING: Do not install or use if any part(s) is/are damaged or missing. This product is designed for use only with the supplied parts and/or accessories designated for use with this product by Modern Forms. Substitution of parts or accessories not designated for use with this product by Modern Forms could result in personal injury or property damage and will void the warranty. Contact an authorized dealer or the manufacturer if any parts are damaged or missing.

WARNING: Before assembling, refer to the "Making the Electrical Connections" section in your fan's installation instructions. If you feel you do not have enough wiring knowledge or experience, have your fan installed by a licensed electrician.

WARNING: Do not use power tools to assemble or install your fan. Using power tools can result in improper assembly which can lead to noise or fan damage, personal injury or property damage.

2. PACKAGE CONTENTS

A

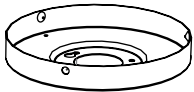

Adapter Plate (light kit plate)

B

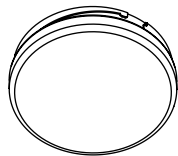

Glass - Etched Opal

C

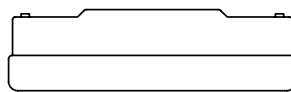

4 in LED Engine

D



Hardware Bag
5/32"x5mm Phil/Slotted Truss
Head Screw *4

MODERN FORMS SMART FANS F-1811-LED

INSTALLATION INSTRUCTIONS

UNINSTALLING THE DECORATIVE LOWER CAP

REMEMBER to : disconnect the power at the circuit breaker.

1. Unthread and remove the decorative lower cap from the motor assembly (FIG. 1).
2. Remove the 3 screws from the wire housing lower cover and keep them for use with the light kit adapter plate. Remove the wire housing lower cover.

FIG. 1

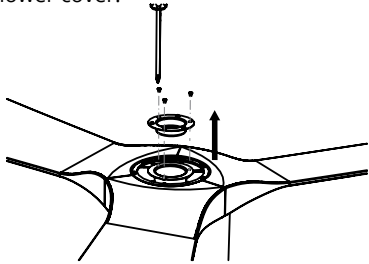

NOTE: If you plan to uninstall the optional LED light kit, store the decorative lower cap and wire housing lower cover in a safe place for later use.

INSTALLING THE LIGHT KIT ADAPTER PLATE

1. Install the adapter plate to the mounting ring using the 3 screws previously removed (FIG. 2).

FIG. 2

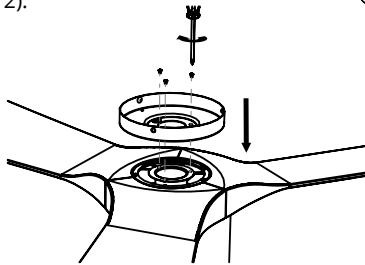

INSTALLING THE LED LUMINAIRE MODULE

1. Raise and hold the LED luminaire module close to the adapter plate and proceed to secure the wire connections. Connect the white wire connector from the LED luminaire module to the white wire of the fan. Follow the same procedure with the black wire connectors (FIG.3).
2. Tuck connections neatly into adapter plate. Using the 3 screws provided, install the LED luminaire module to the adapter plate (FIG. 4).
3. Raise glass shade up against the luminaire module and secure it to fan by turning the glass clockwise until snug. Do not over-tighten (FIG. 5).

FIG. 3

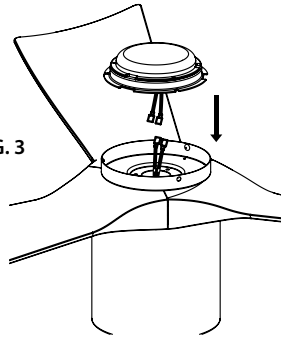

FIG. 4

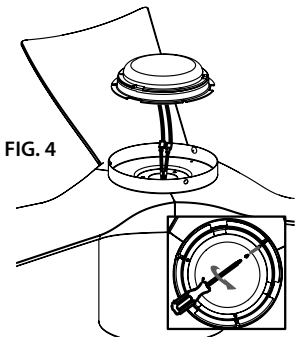

FIG. 5

