

CRYSTORAMA

LIGHTING THE WAY FOR SIXTY YEARS

ASSEMBLY INSTRUCTION MODEL #6823-CH-CL-MWP

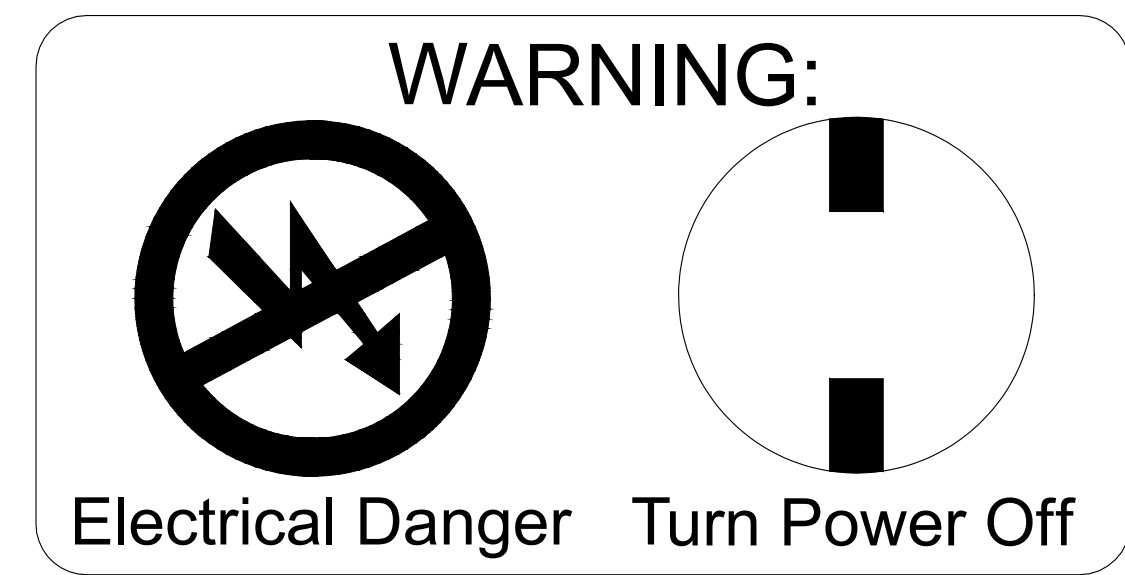
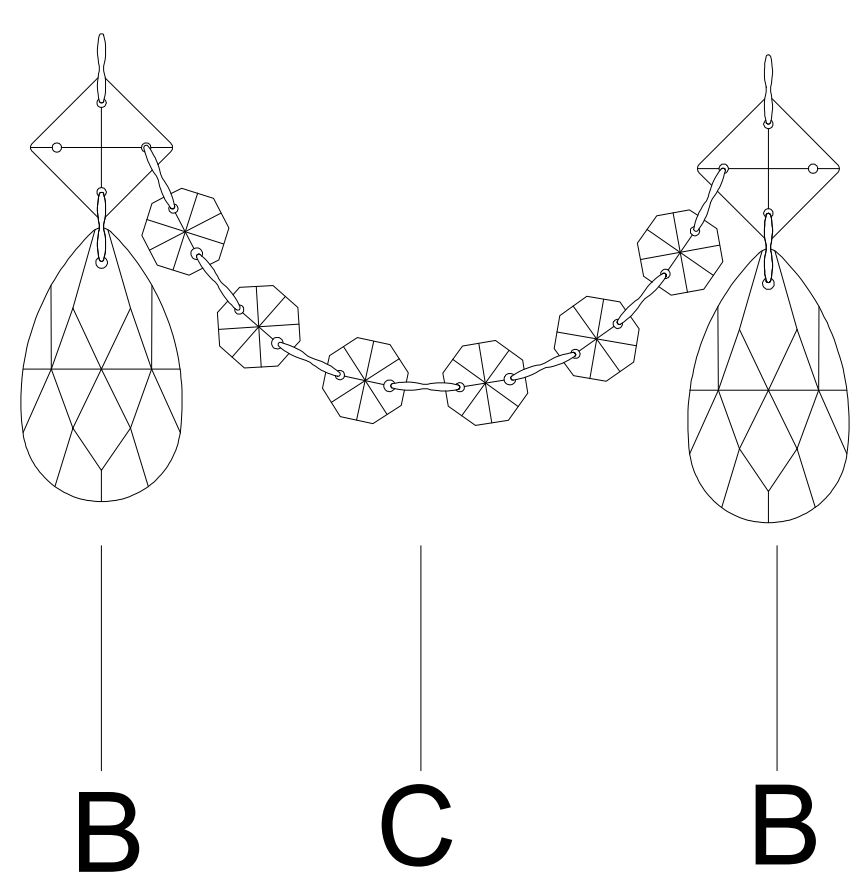
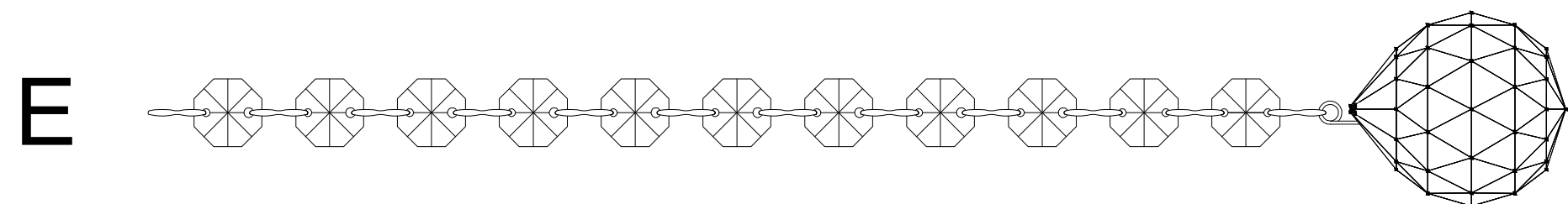
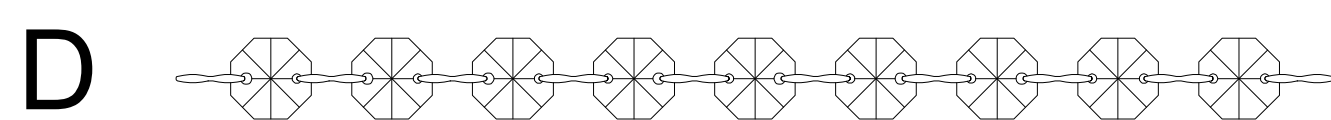
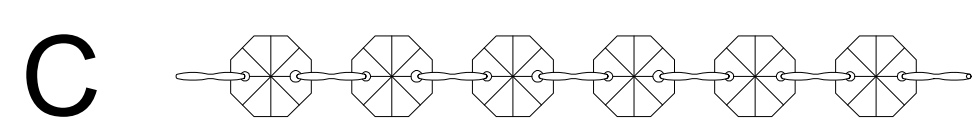
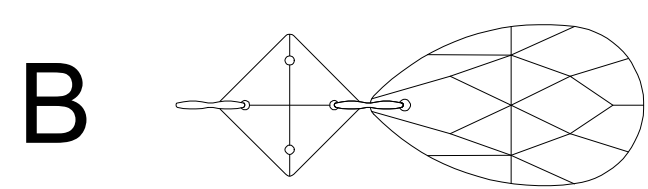
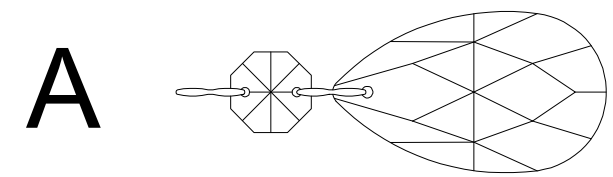
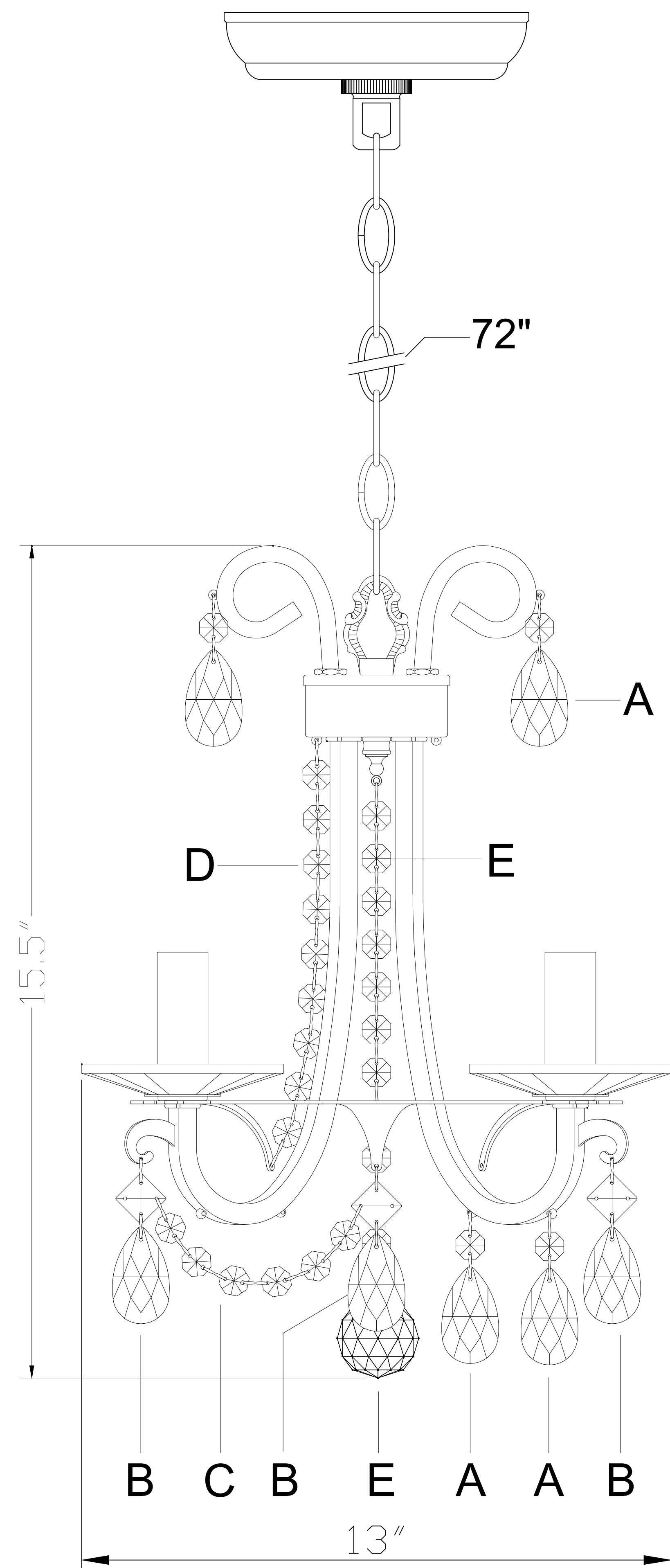

All electrical components must be installed by a licensed electrician in accordance with the National Electric Code and the appropriate local electrical codes.

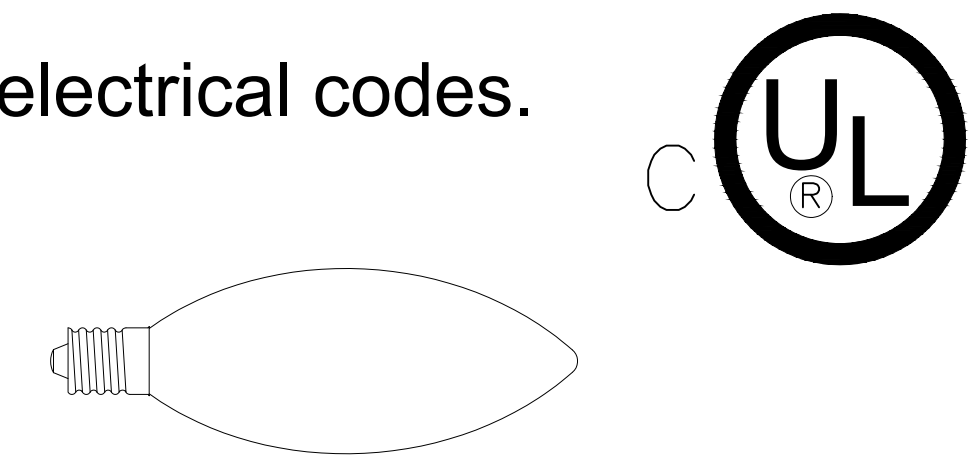

You will need 3-Candelabra Base Bulb
40Watts Recommended 60 Watts Max.

USE LED BULBS FOR EXTENDED USE

The fixture is damp rated

How to Install

1. Place the top assembly over the frame and secure with the loop.
2. After safely attaching the fixture into the outlet box, install bobeches, bulbs and proceed to connecting the power.
3. When you begin to dress the fixture, start with packet labeled (A).
4. **IMPORTANT:** Apply crystal sets in alphabetical order.

Crystal Sets

- A. (14mm+50mm)x9sets
- B. (18mm Square+50mm)x6sets
- C. (14mmx6pcs)x6set
- D. (14mmx9pcs)x3set
- E. (14mmx11pcs+30mm Ball)x1set

WARNING: This product can expose you to lead which is known to the State of California to cause cancer and/or birth defects or reproductive harm. For more information go to www.P65Warnings.ca.gov

CRYSTORAMA

LIGHTING THE WAY FOR SIXTY YEARS

ASSEMBLY INSTRUCTION MODEL #6823-CH-CL-MWP

Part Number

Part Numbers

- A. (3)-Wire Connector
- B. (1)-Mounting Plate
- C. (1)-Ground Screw
- D. (1)-Nipple
- E. (2)-Outlet Box Screws
- F. (1)-Canopy (W5.1" xH1") XEH6623CHCAN5IN
- G. (1)-Collar Loop
- H. (1)-Collar Ring
- I. (1)-Chain;72",4mm XEH6623CHCHA4MM
- J. (1)-Loop
- K. (1)-Top Assembly
- L. (1)-Frame
- M. (3)-Bobeche (D3.9" x Hole:1") XEH6623BOB4IN
- N. (3)-Metal Sleeve (H2.75") XEH6623CHMCDL2.75IN
- O. (3)-Plastic Sleeve (H2.75") XEH6623PCDL2.75IN

Outlet box

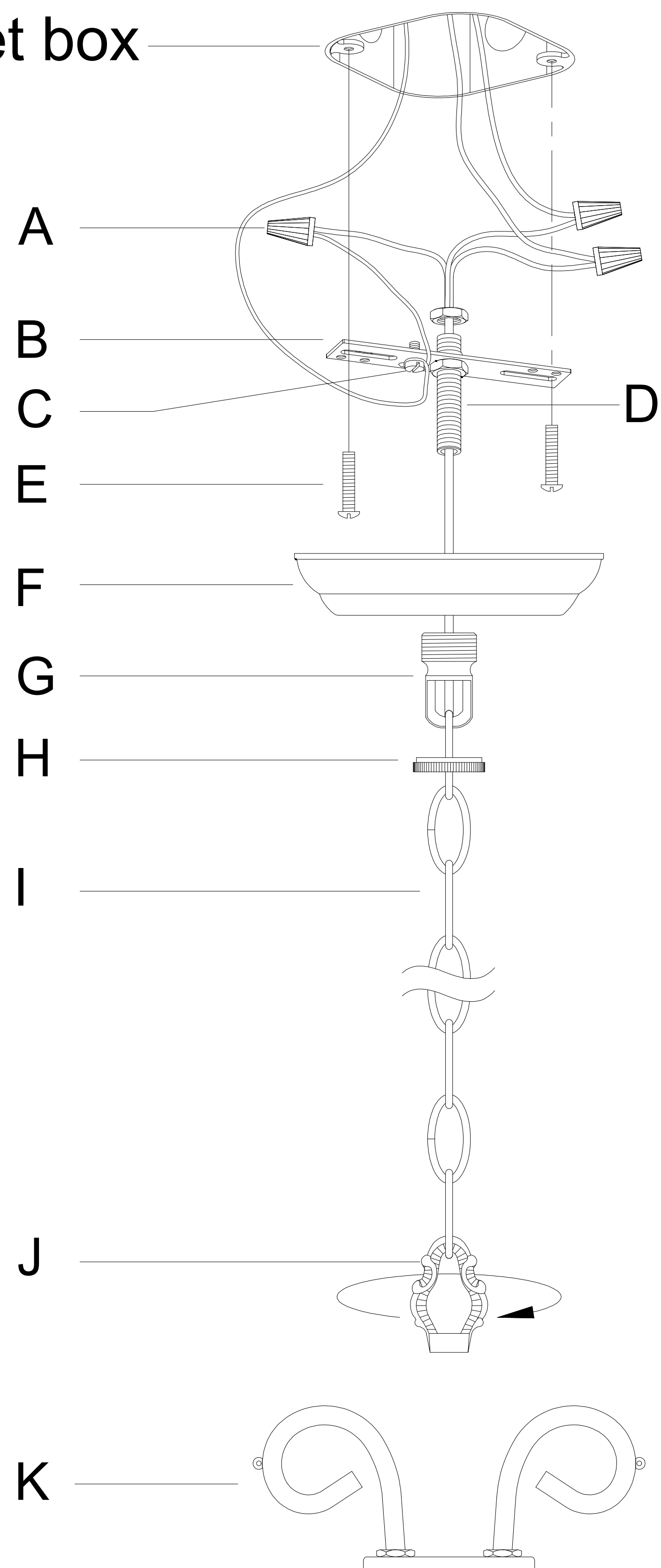

Place the (K) Top assembly on top of (L) Frame then secure them by tightening the (J) Loop.

