

Trade Mark:
CRYSTAL WORLD INC

Product Name: Pendant lamp

Model :9700P15-6

120Vac, 60Hz,AC ONLY

Lamp Size:D15"*H23"

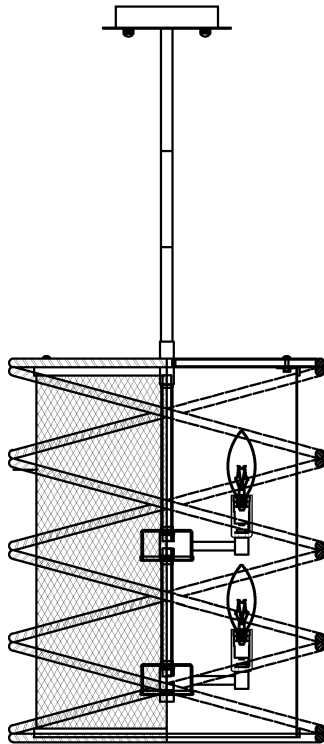

PENDANT LAMP ASSEMBLY INSTRUCTIONS

1. Please fix part(A) with part(B),part(C) with part(B).
2. Install bulbs (NOT INCLUDED).USE **120V E12**  **6*40W Max.**

