



**SCHONBEK®**

**RENAISSANCE 3790- \_ \_ \_**



**T**HIS DESIGN IS THE PROPRIETARY TRADE DRESS/TRADemark OF SWAROVSKI LIGHTING, LTD.

12 + 1 Lights  
Diameter: 33"  
Body Length: 26"  
Hanging Weight: 50 lbs.



**SCHONBEK®**

MAX 60 W	MAX 15 W	110-120 V					

SCHONBEK® is a member of the Swarovski group.

All electrical components must be installed by a licensed electrician in accordance with the National Electric Code and the appropriate local electrical codes.

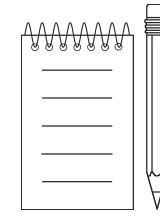
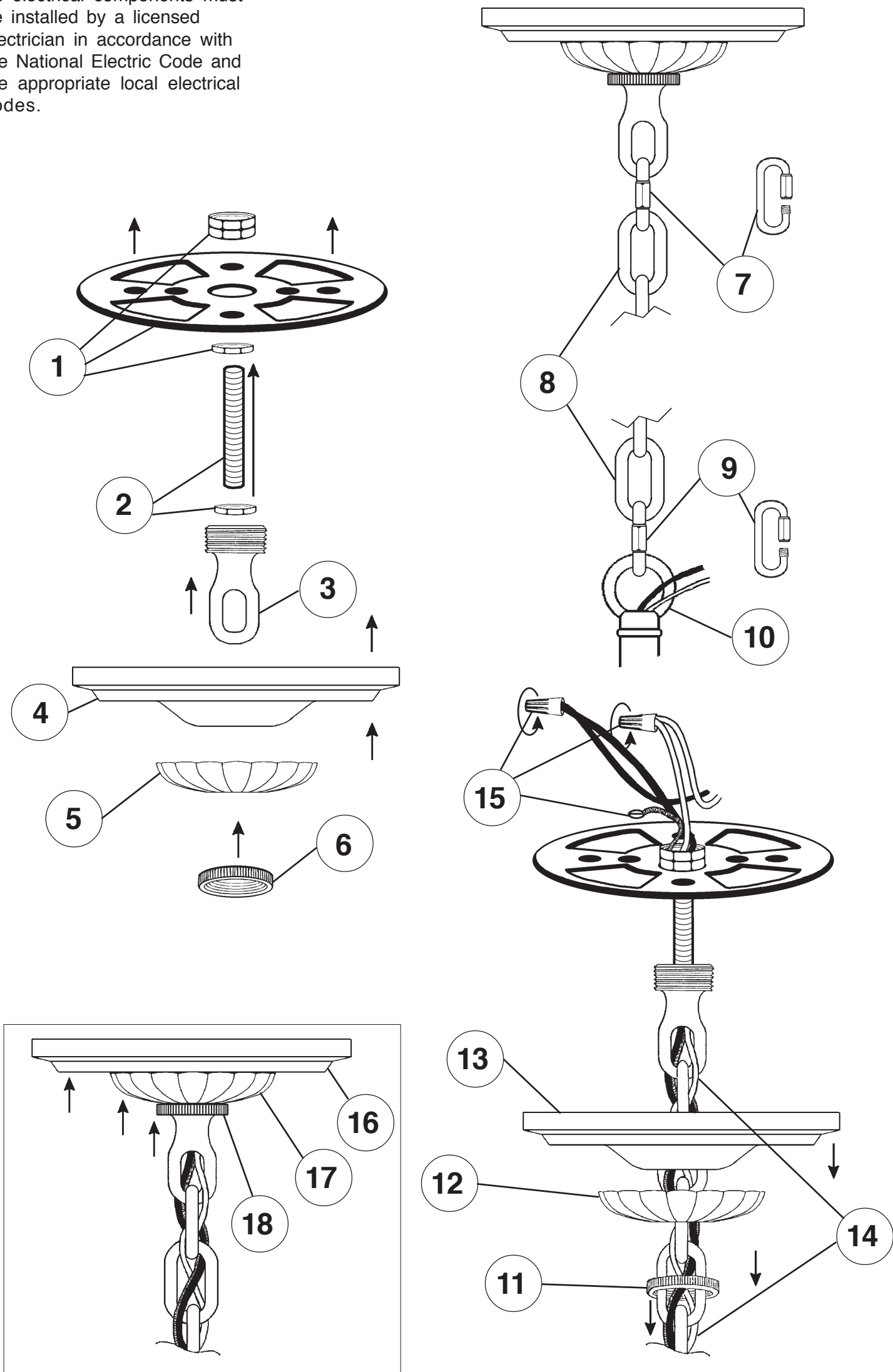

**Crystal Set #3 in Black**

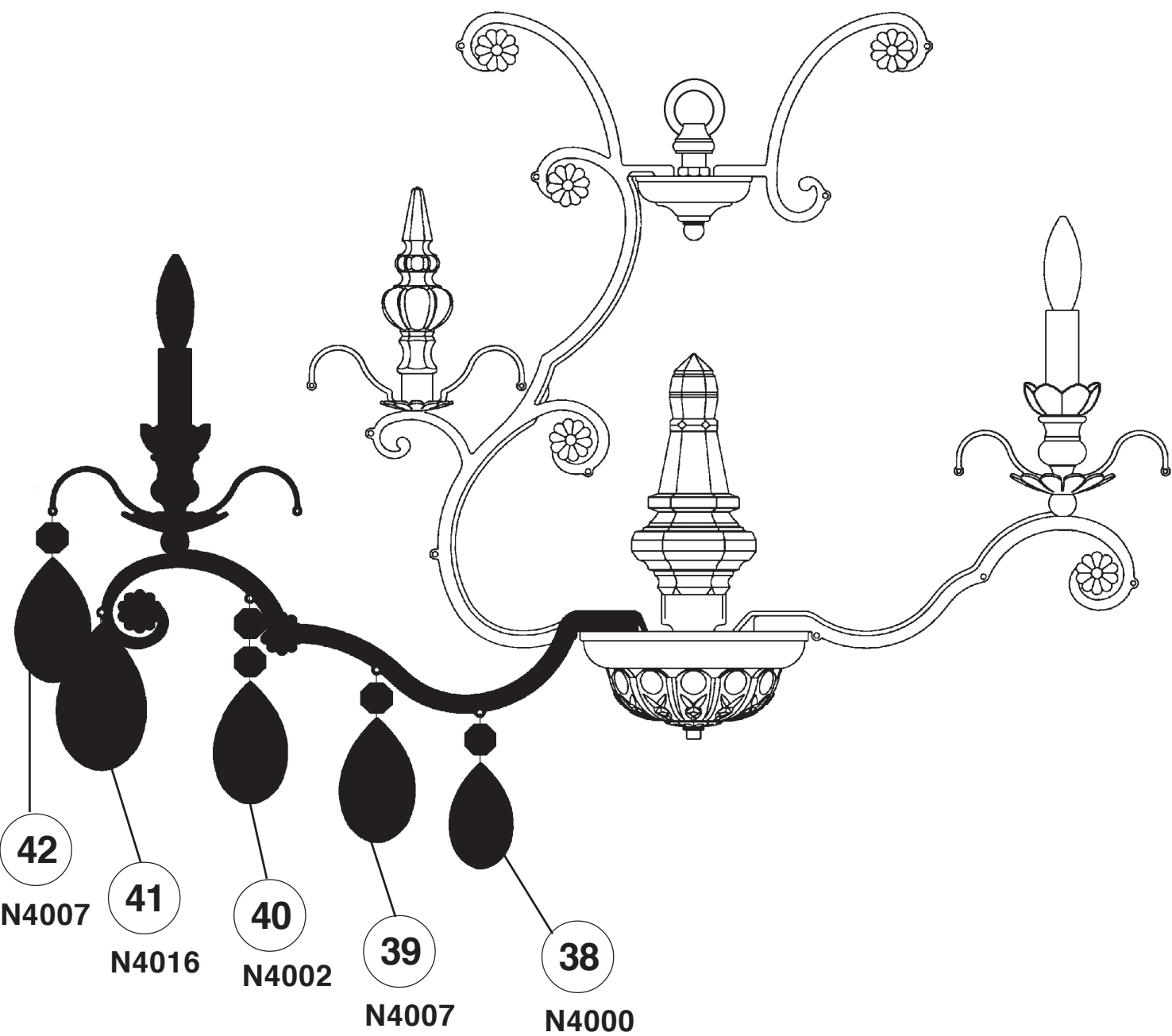

**SET #1**

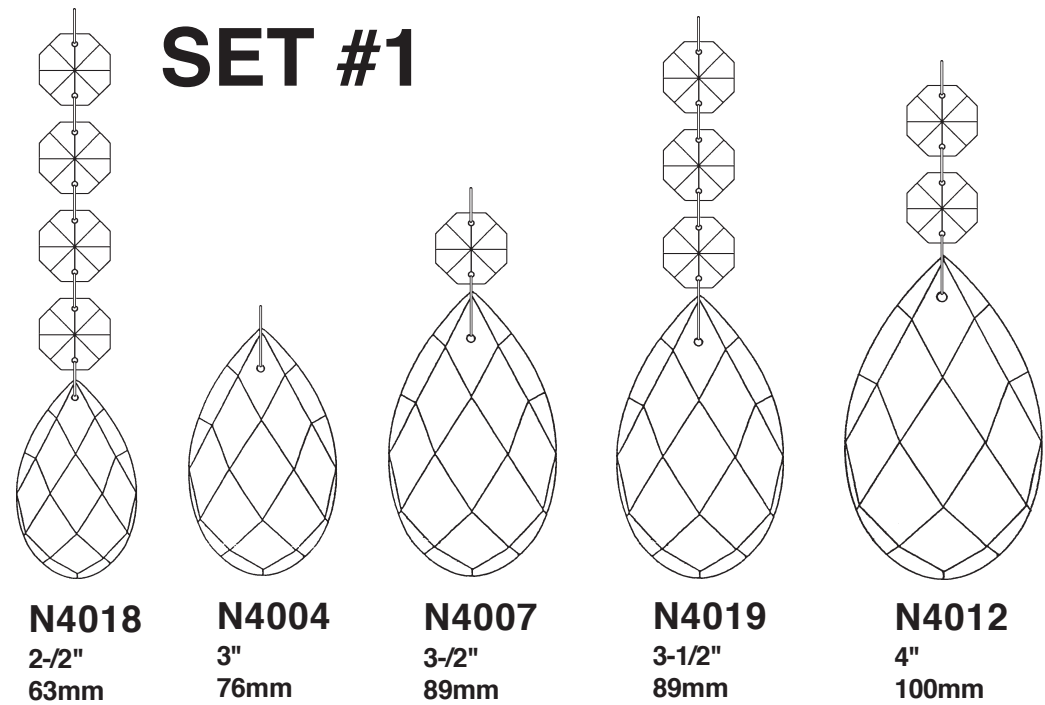

**SET #2**

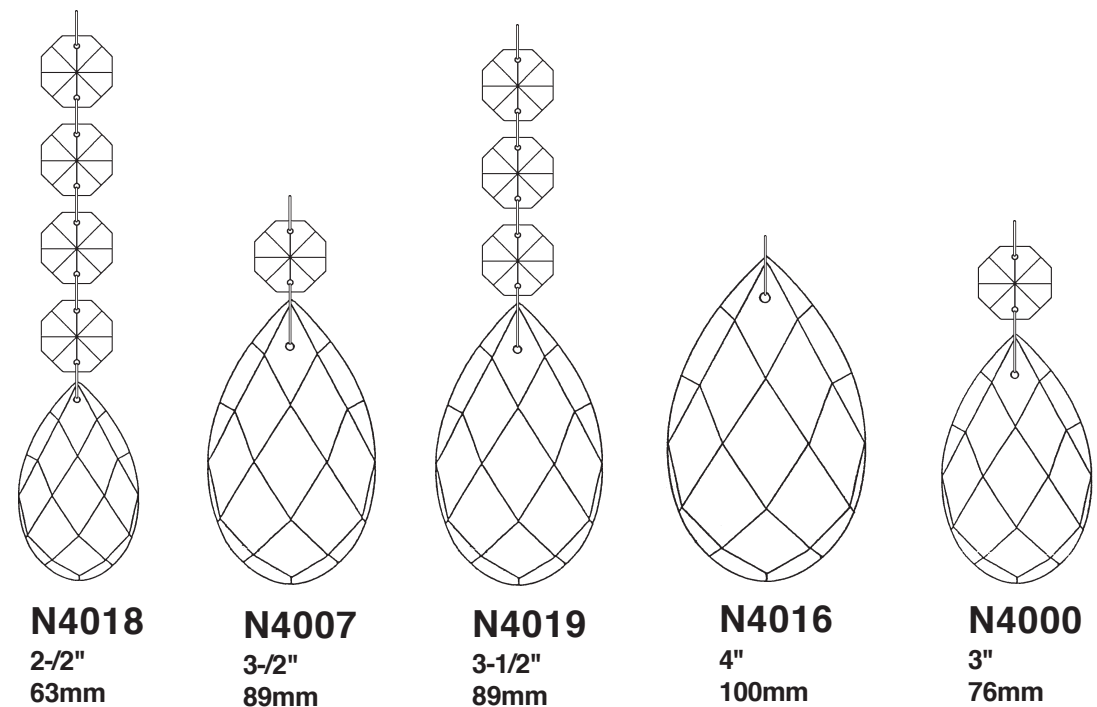

**SET #3**

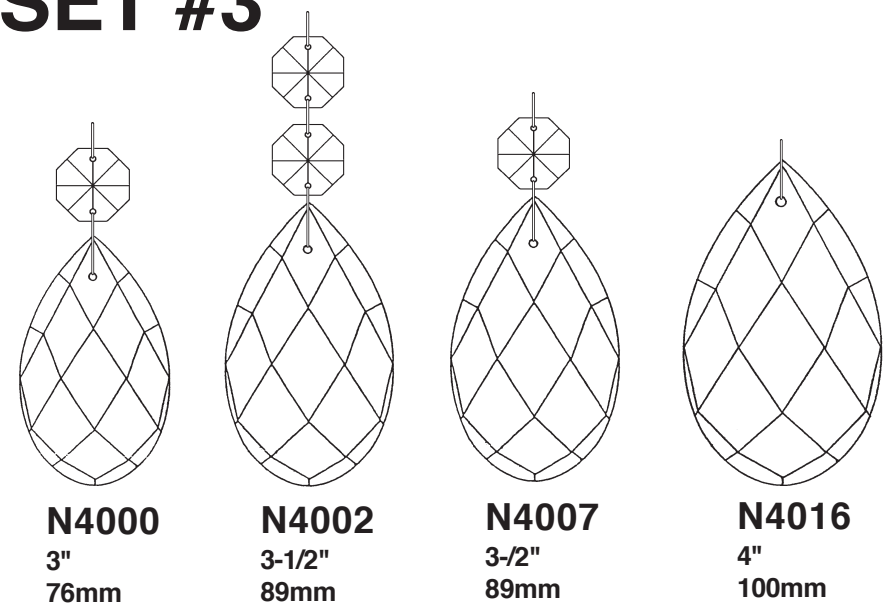

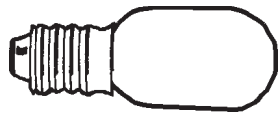

You will need 1 - T7  
15 Watts Max  
(Center Light)

20



You will need 12 - B10  
25 Watts Recommended  
60 Watts Max

Install bulbs and be sure  
to test fixture BEFORE  
trimming.

**Crystal Set #1 in Black**

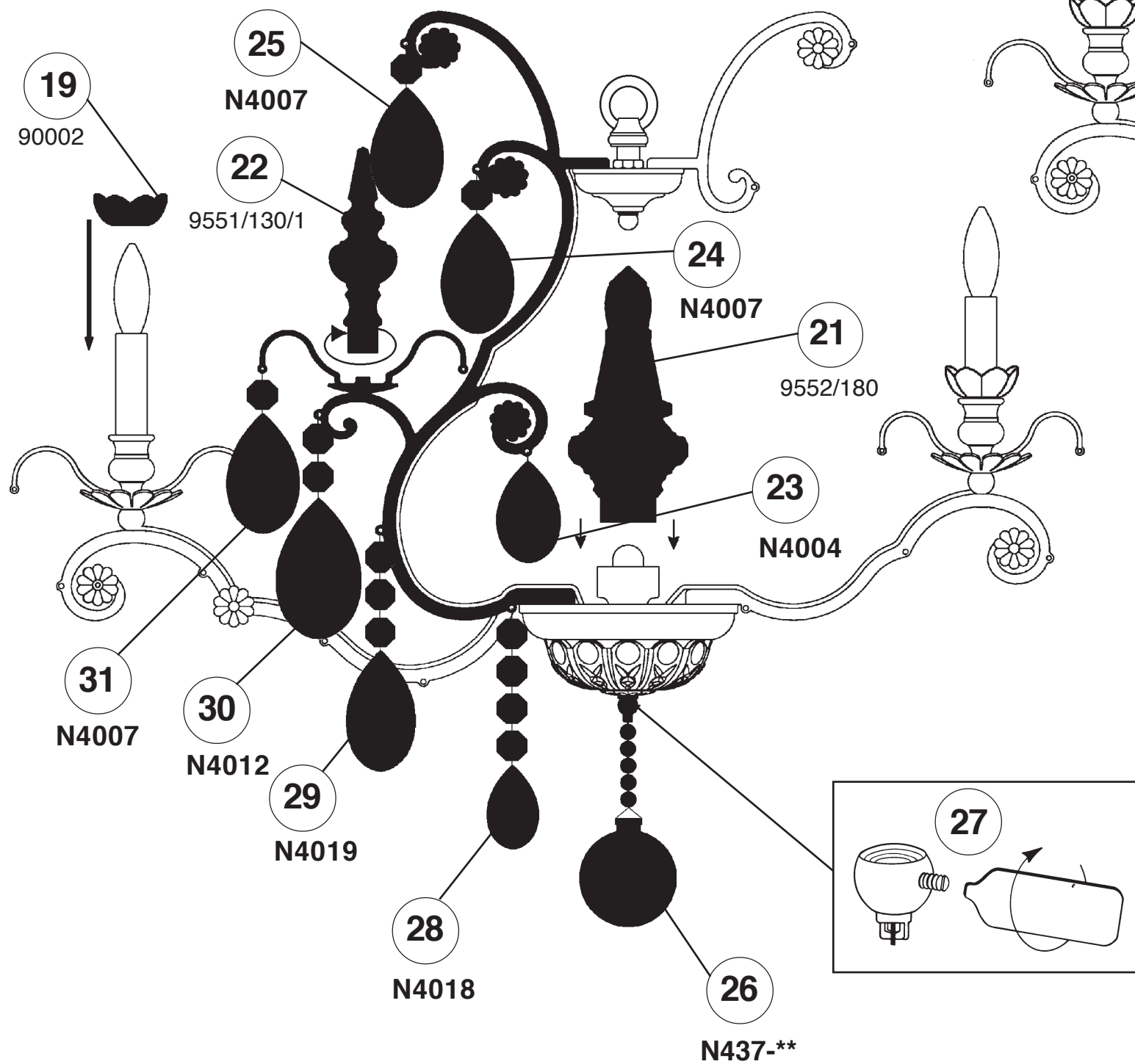

**Crystal Set #2 in Black**

