

STEP 4 - Wire Connections .

A. Use standard wire connectors to make all wire connections. Twist connectors until wires are tightly joined together. Wrap each connection with approved electrical tape and carefully stuff all the connected wires into the Outlet Box.

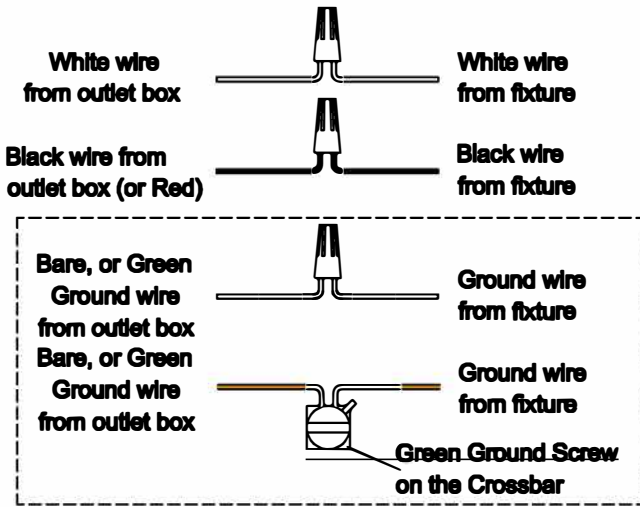

Figure 4

STEP 5 - Install Ceiling Canopy to Ceiling .

A. Carefully tuck all wires into the outlet box and position the ceiling canopy of the Fixture Body (A) over the outlet box. Align the holes in the ceiling canopy with the Mounting Screws (DD). Secure with Decorative Caps (AA) and hand tighten until snug.

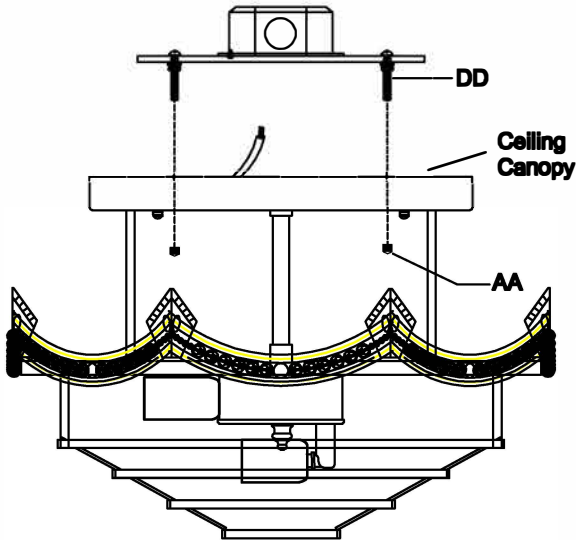
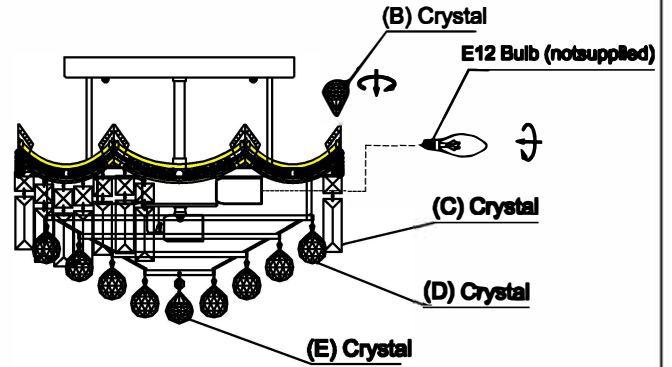

Figure 5

STEP 6 - Install Crystal and Bulbs.

A. Install bulbs onto sockets and push snug into place.

B. Please put the crystal (B) (C) (D) and (E) to the Fixture Body (A) .







- | | | |
|--|--|---|
| B | C | D |
|  40mm*1PCS |  22mm*1PCS
63mm*1PCS |  40mm*1PCS |
| Crystal x8 PCS | Crystal x48 PCS | Crystal x60 PCS |
| E | | |
|  14mm*1PCS
40mm*1PCS | | |
| Crystal x1 PCS | | |

Figure 6