

CRYSTORAMA

LIGHTING THE WAY FOR SIXTY YEARS

ASSEMBLY INSTRUCTION MODEL #CLO-8894-AG

WARNING:



Electrical Danger



Turn Power Off

All electrical components must be installed by a licensed electrician in accordance with the National Electric Code and the appropriate local electrical codes.

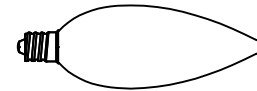

You will need 4-Cand.BULB
60 watts Max Bulb not included
USE LED BULBS FOR EXTENDED USE

How to Install

1. Connect the fixture onto the outlet box in the ceiling
2. Install the recommended bulbs (not included) into each socket, install crystal on canopy and bottom ring
3. Insert each long threaded crystal ball through the bottom of the ring, then secure it from the top with the crystal ball (without nipple).

CRYSTAL SETS:

- E: Ø30mmx40, Crystal ball with long thread
- Ø30mmx40, Crystal ball
- G: Ø6mmx10, Ø8mmx10, Ø40mmx1

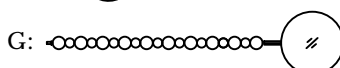
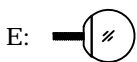
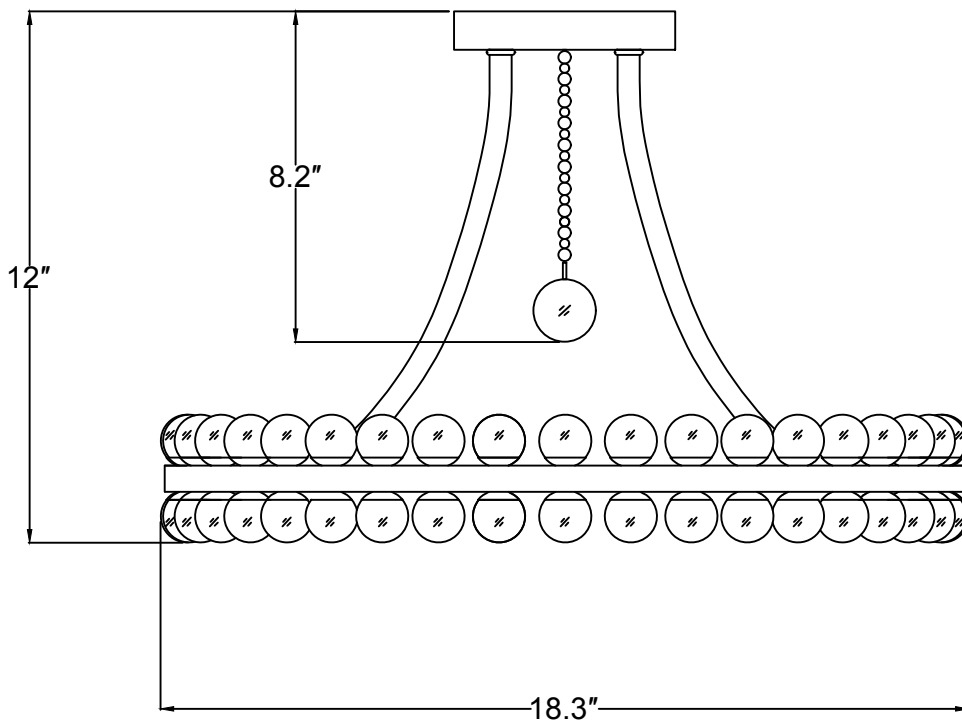

WARNING: This product can expose you to Lead, which is known to the State of California to cause cancer and/or birth defects or reproductive harm. For more information go to www.P65Warnings.ca.gov

CRYSTORAMA

LIGHTING THE WAY FOR SIXTY YEARS

PART NUMBER MODEL #CLO-8894-AG

Part Number

Part Numbers

A. Mounting Hardware

(1) Mounting Plate

(2) Mounting Screw

(3) Wire Nut

(3) Outlet Box Screws

B. (1) Canopy; $\varnothing 5" \times 0.87" h$; XMO8894AGCAN5IN

C. (4) Arm; $\varnothing 0.5"$



D. (1) Bottom Ring

E. (80) Crystal Ball; $\varnothing 1.18"$

F. (4) Candle Sleeve; $\varnothing 1" \times 2.8"$; XMO8890AGCDL2.8IN

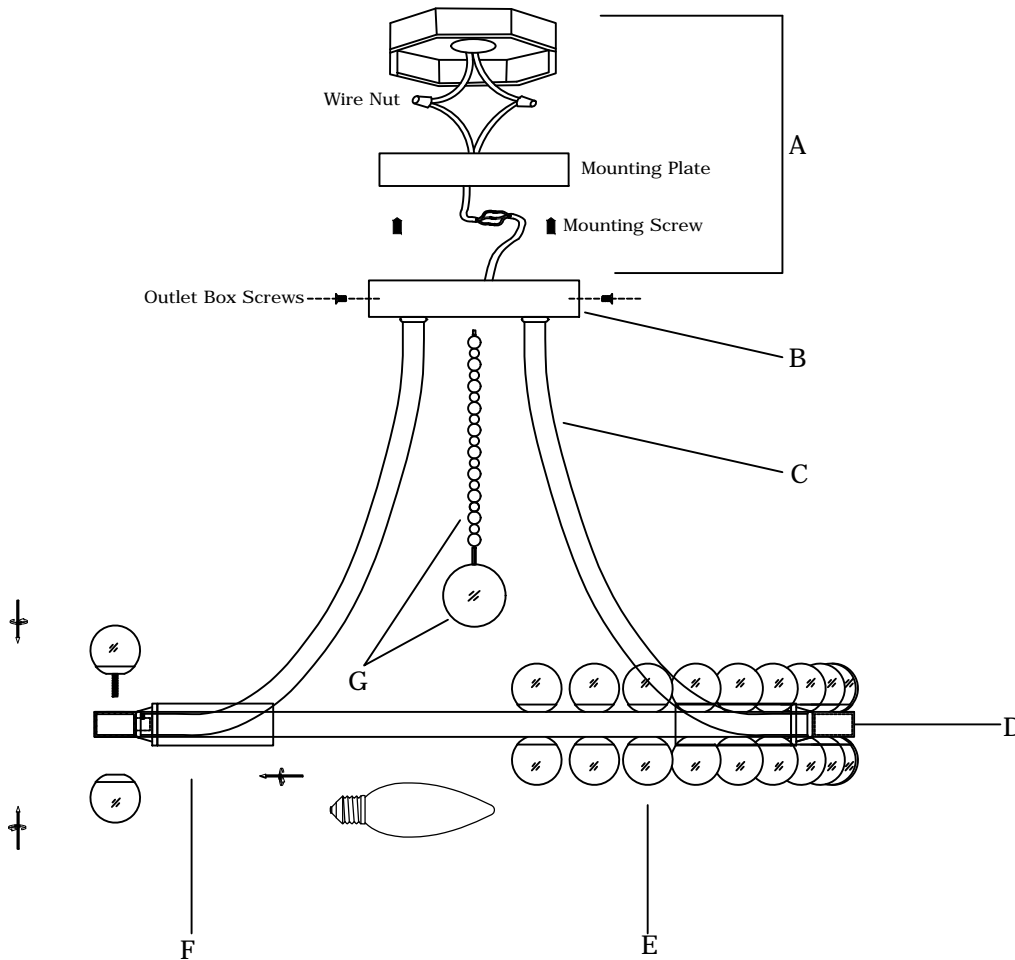
G. (1) Strand Crystal



	
x2	x3
Mounting Screw	Wire Nut