

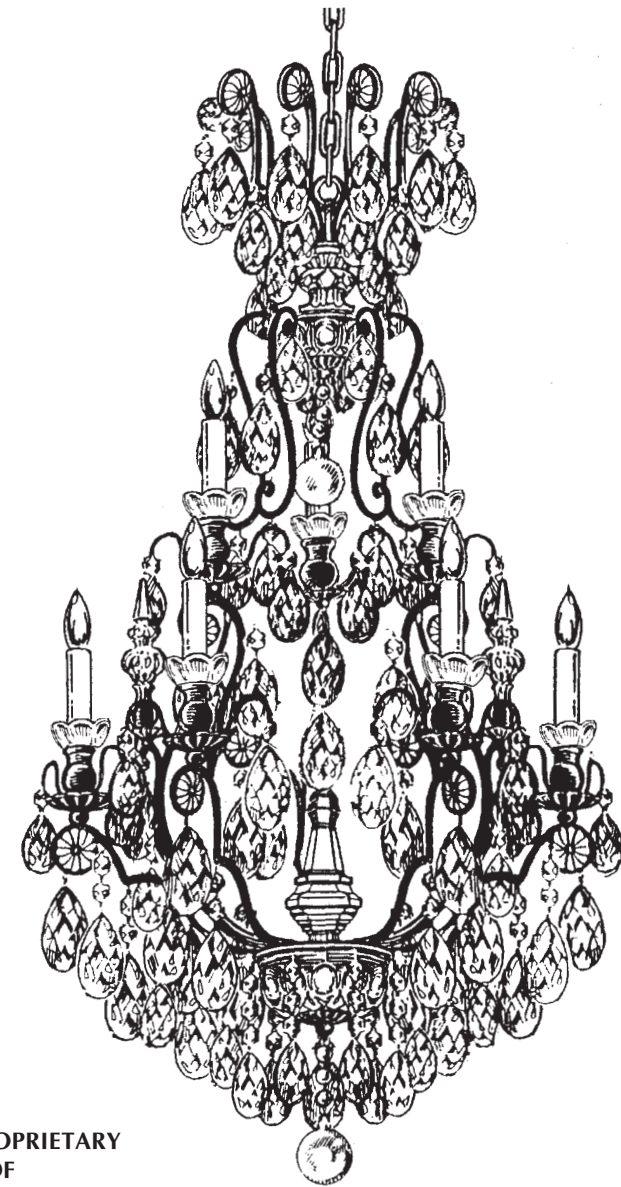

SCHONBEK®

RENAISSANCE 3780- __ __ TK



THIS DESIGN IS THE PROPRIETARY TRADE DRESS/TRADemark OF SWAROVSKILIGHTING, LTD.

9 + 1 Lights
Diameter: 21"
Body Length: 40"
Hanging Weight: 38 lbs.



SCHONBEK®

MAX 60 W	MAX 15 W	110-120 V					

SCHONBEK® is a member of the Swarovski group.

All electrical components must be installed by a licensed electrician in accordance with the National Electric Code and the appropriate local electrical codes.

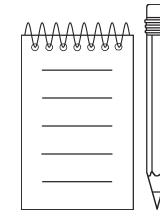
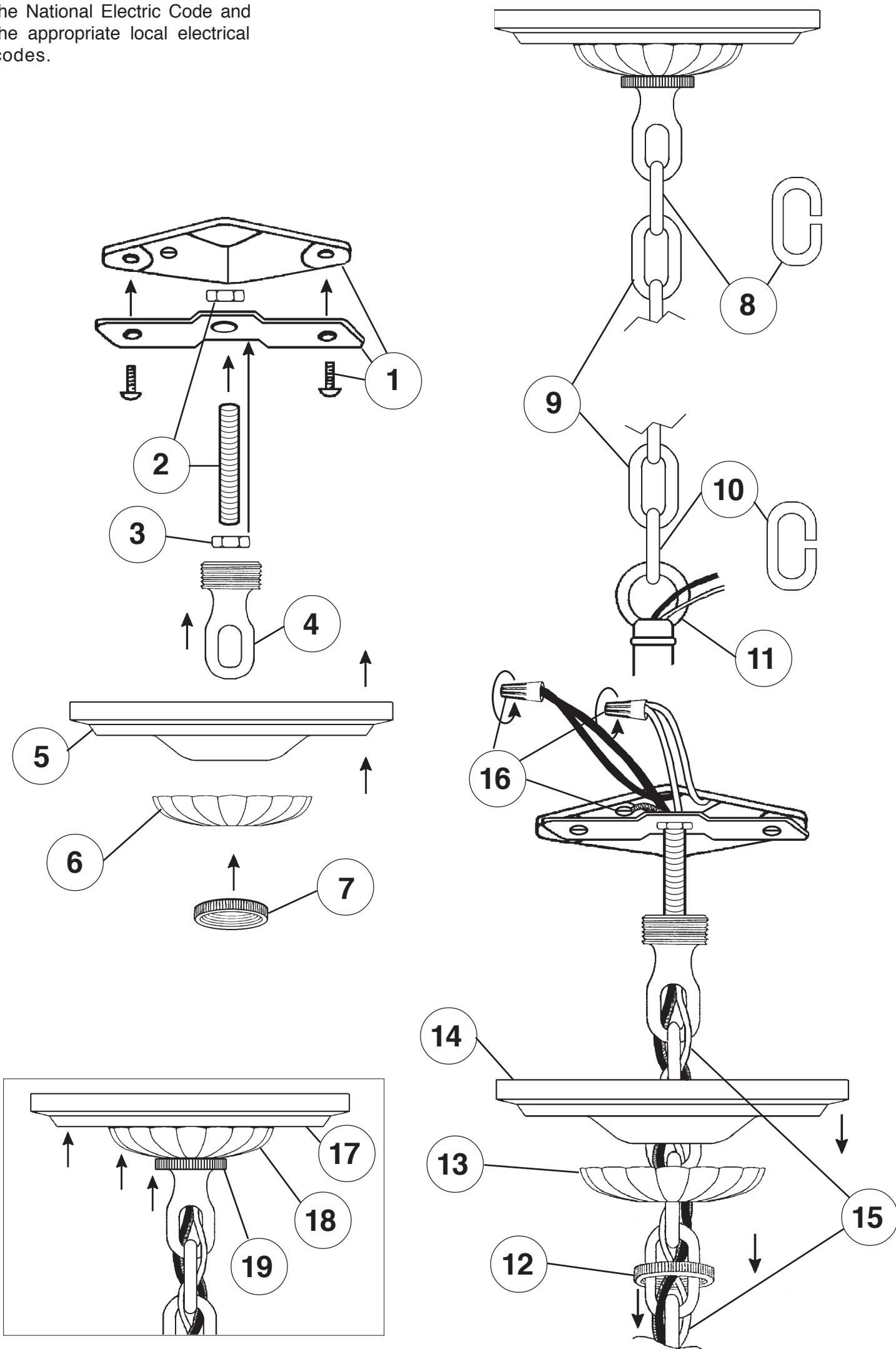

Crystal Set #3 in Black

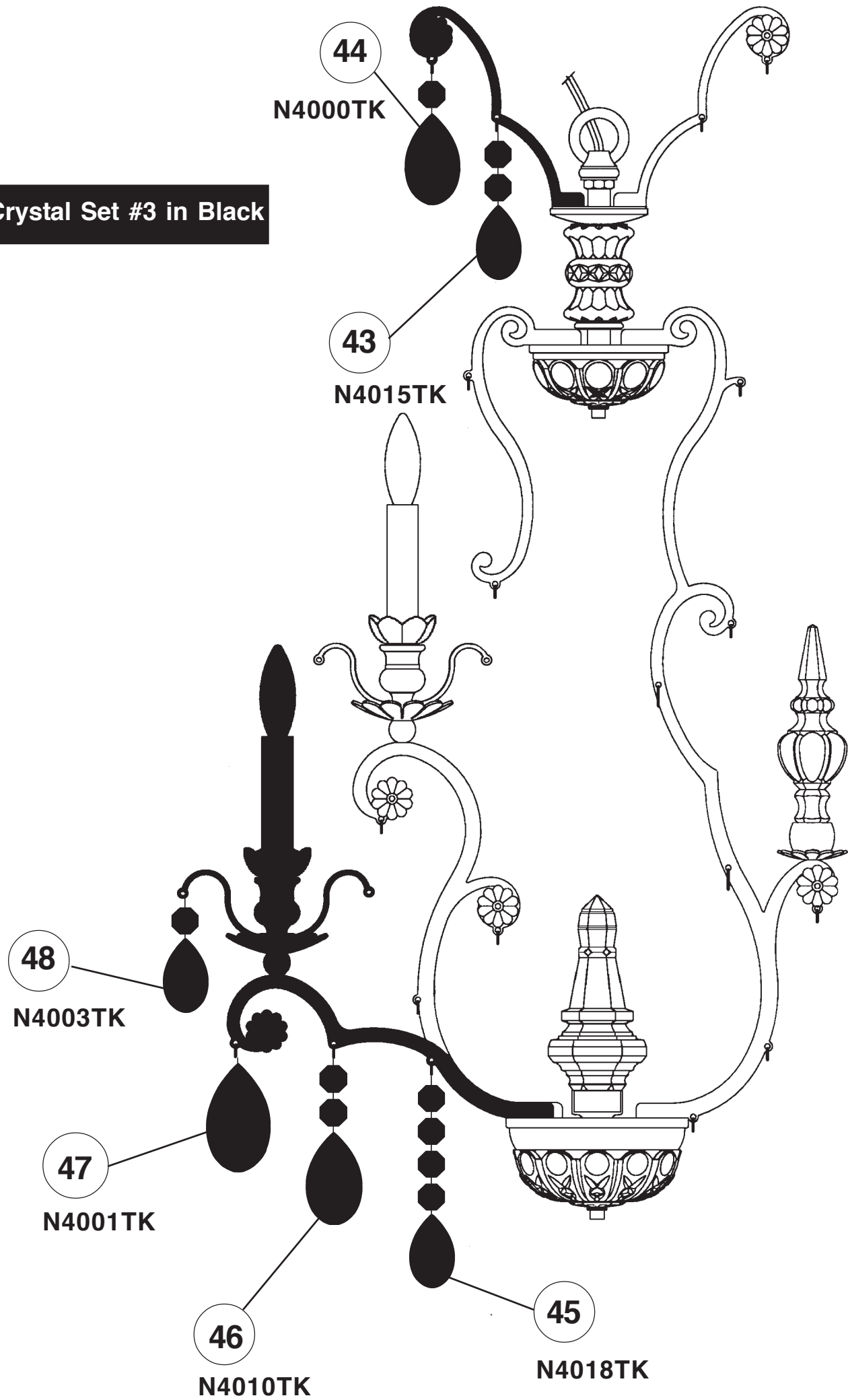

SET #1

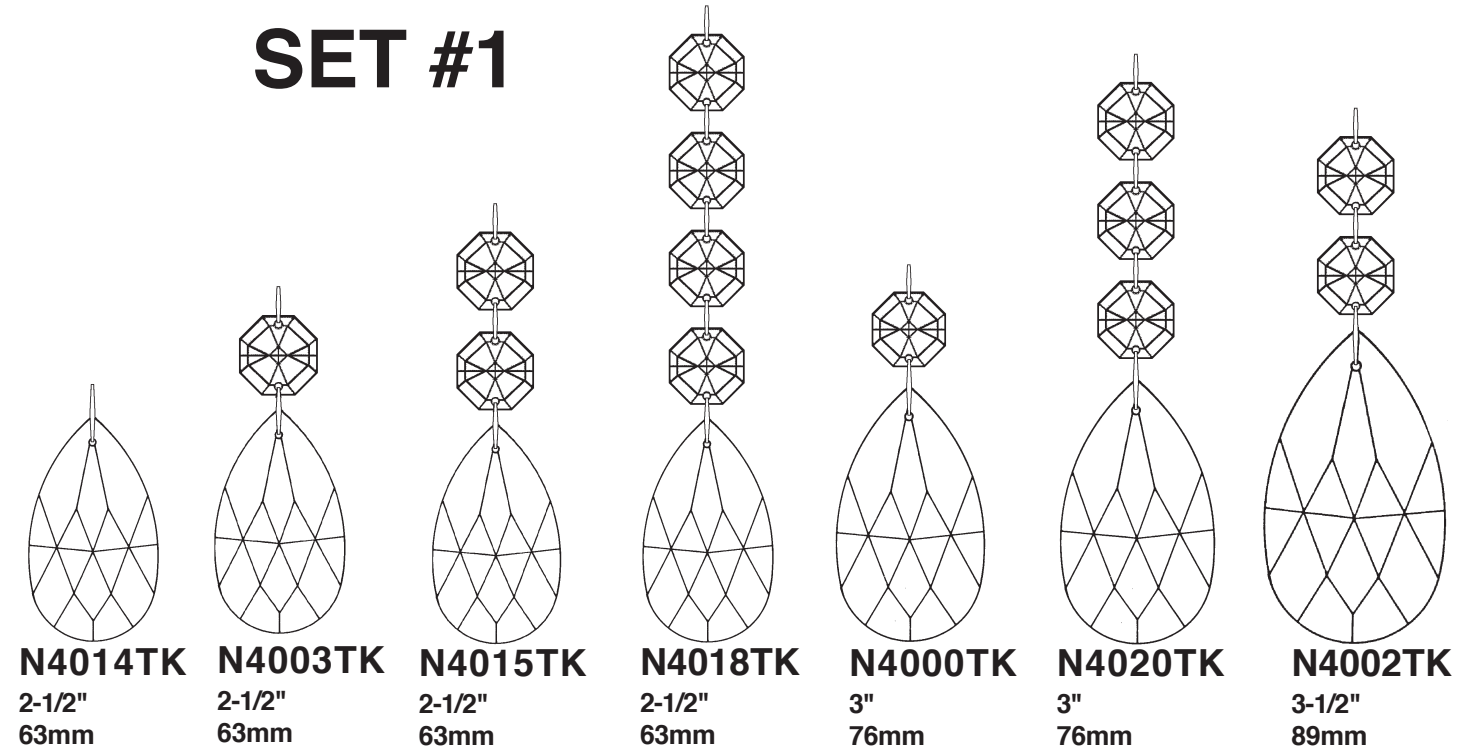

SET #2

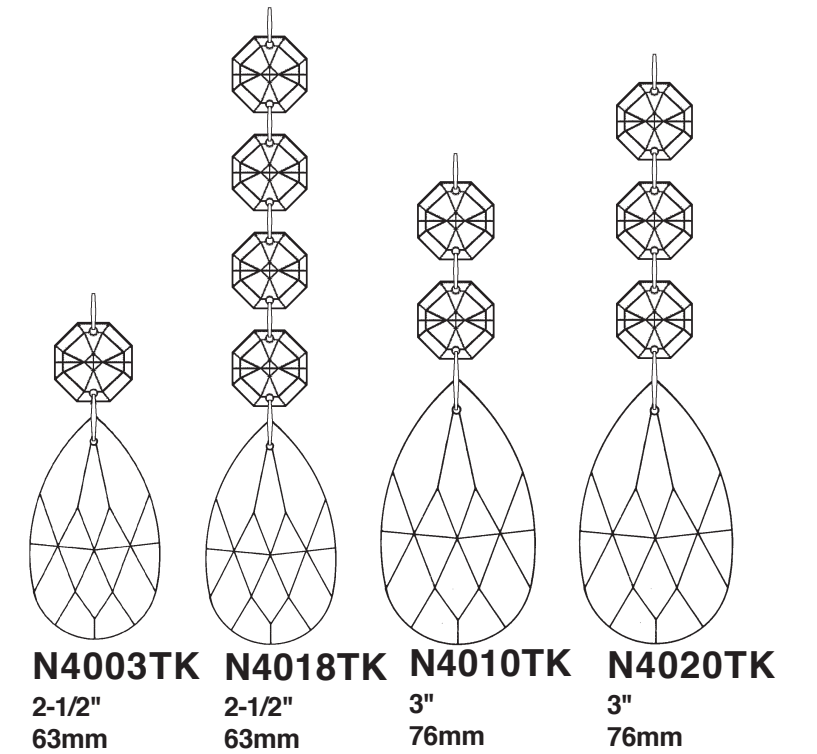

SET #3

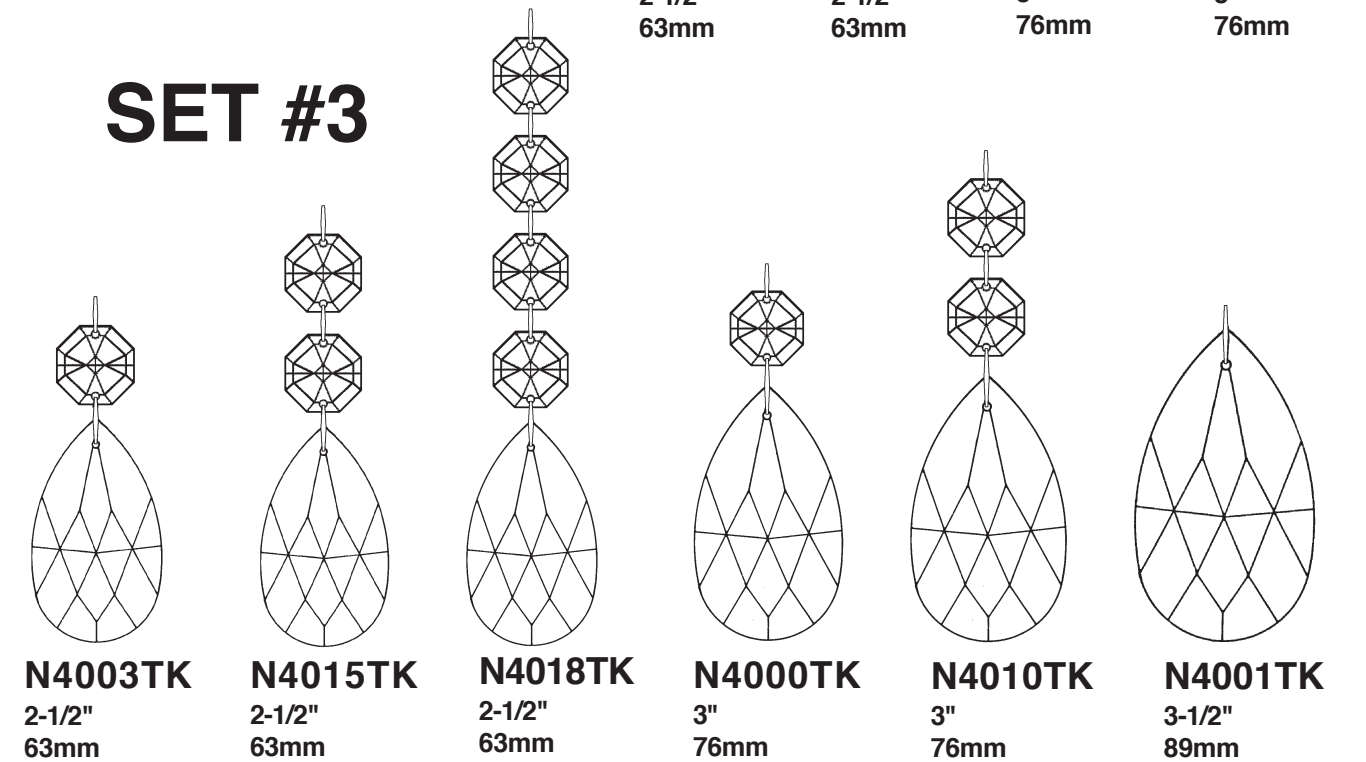

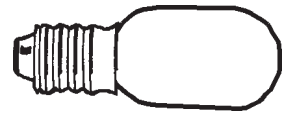

You will need 1 - T7
15 Watts Max
(Center Light)

21

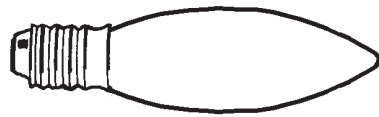

You will need 9 - B10
25 Watts Recommended
60 Watts Max

Install bulbs and be sure
to test fixture BEFORE
trimming.

Crystal Set #2 in Black

Crystal Set #1 in Black

