

SAFETY INFORMATION

Please read and understand this entire manual before attempting to assemble, install or operate the product.

WARNING

- RISK OF ELECTRIC SHOCK - Before beginning installation, turn off electricity at the circuit breaker box or the main fuse box.

CAUTION

- For your safety, read instructions completely before beginning installation.
- If in doubt about electrical installation, consult a licensed electrician.

TOOLS REQUIRED

Rating	120Vac, 60Hz	
	Model No.	Wattage
	PCIB1718BRG	20W

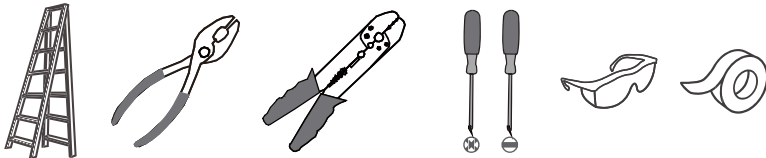

CARE AND MAINTENANCE

- Wipe clean using soft, dry cloth or static duster. Always avoid using harsh chemicals and abrasives to clean fixture as they may damage the finish.

If you need further assistance call Quoizel Customer Care at 1-800-645-3184 (9:00am - 5:00pm EST), or visit us on-line at www.quoizel.com.

PACKAGE CONTENTS

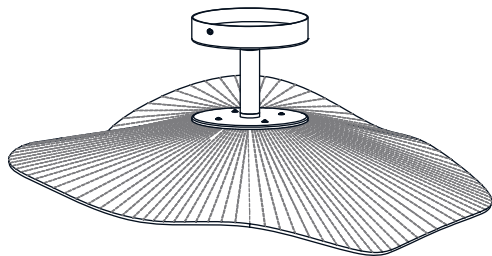

A Fixture Body
x 1

MOUNTING HARDWARE

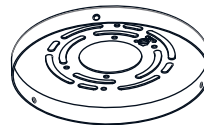

AA Crossbar
x 1

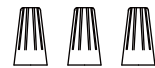

CC Wire Connector
x 3



BB Mounting Screw
x 3



DD Outlet Box Screw
x 2

INSTALLATION

1 Install Crossbar

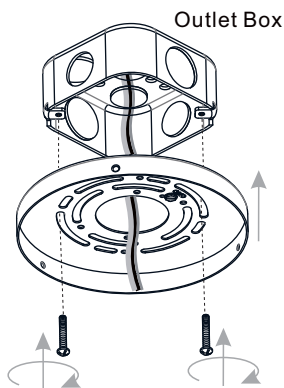

2 Wiring

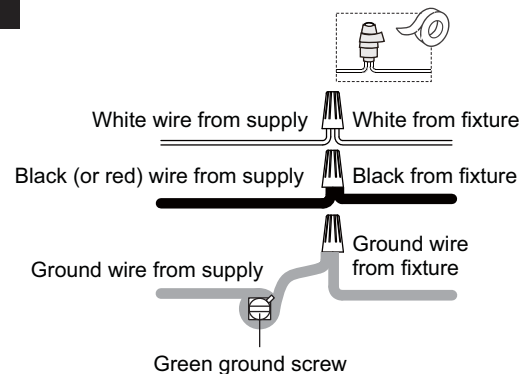

3 Install Fixture Body to Crossbar

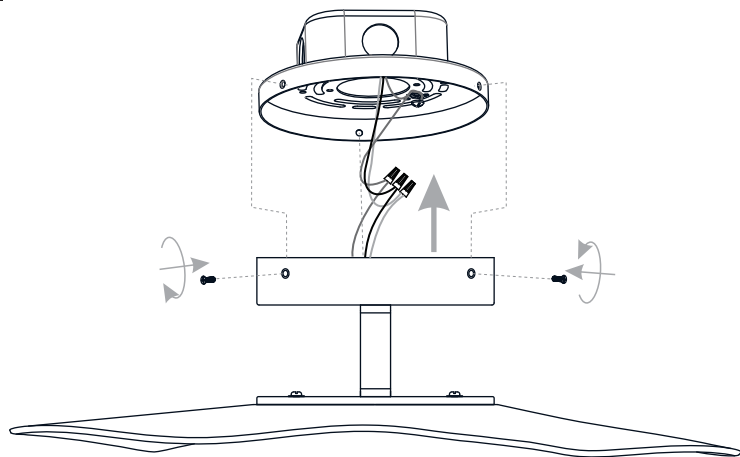

Your installation is now complete! Restore electricity and save this sheet for future reference.