

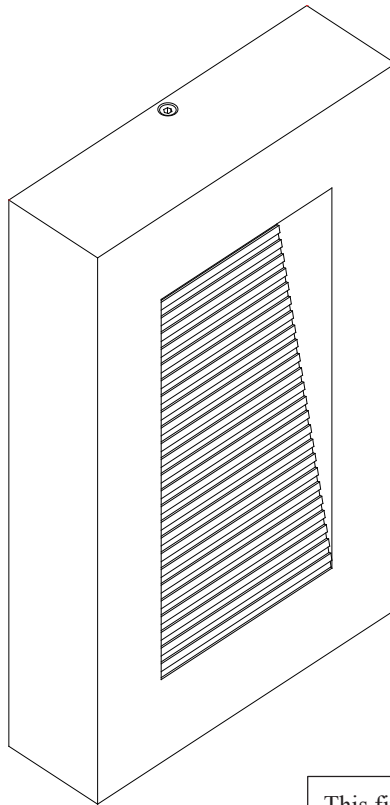

PRODUCT NAME: Path
ITEM NUMBER: 54350ABZ

Please consult your electrician for hanging fixture and wiring.



To prevent water intrusion, caulk around back-plate where fixture meets the wall using outdoor silicone sealant. Leave a small gap at the bottom to allow moisture to exit.

This fixture is designed to dim with an Electronic Low Voltage dimmer. Dimming levels will vary by dimmer. Below is a List of Recommended Dimmers:

- Lutron DVELV-330P
- Lutron MAELV-600M
- Lutron SAELV-153P
- Leviton IPL06-10Z
- Leviton 6674-POW
- Legrand Tru-Universal ADTP703TUW4

Due to inrush current wattage should not exceed 150 watts of product for a 600 watt dimmer.

IMPORTANT: Turn off the power at the main fuse or circuit breaker box before starting installation



(A)

Mounting bracket



(B)

Wire Nuts (x3)



(C)

Mounting screws (x2)

Locate all hardware & components before discarding packaging

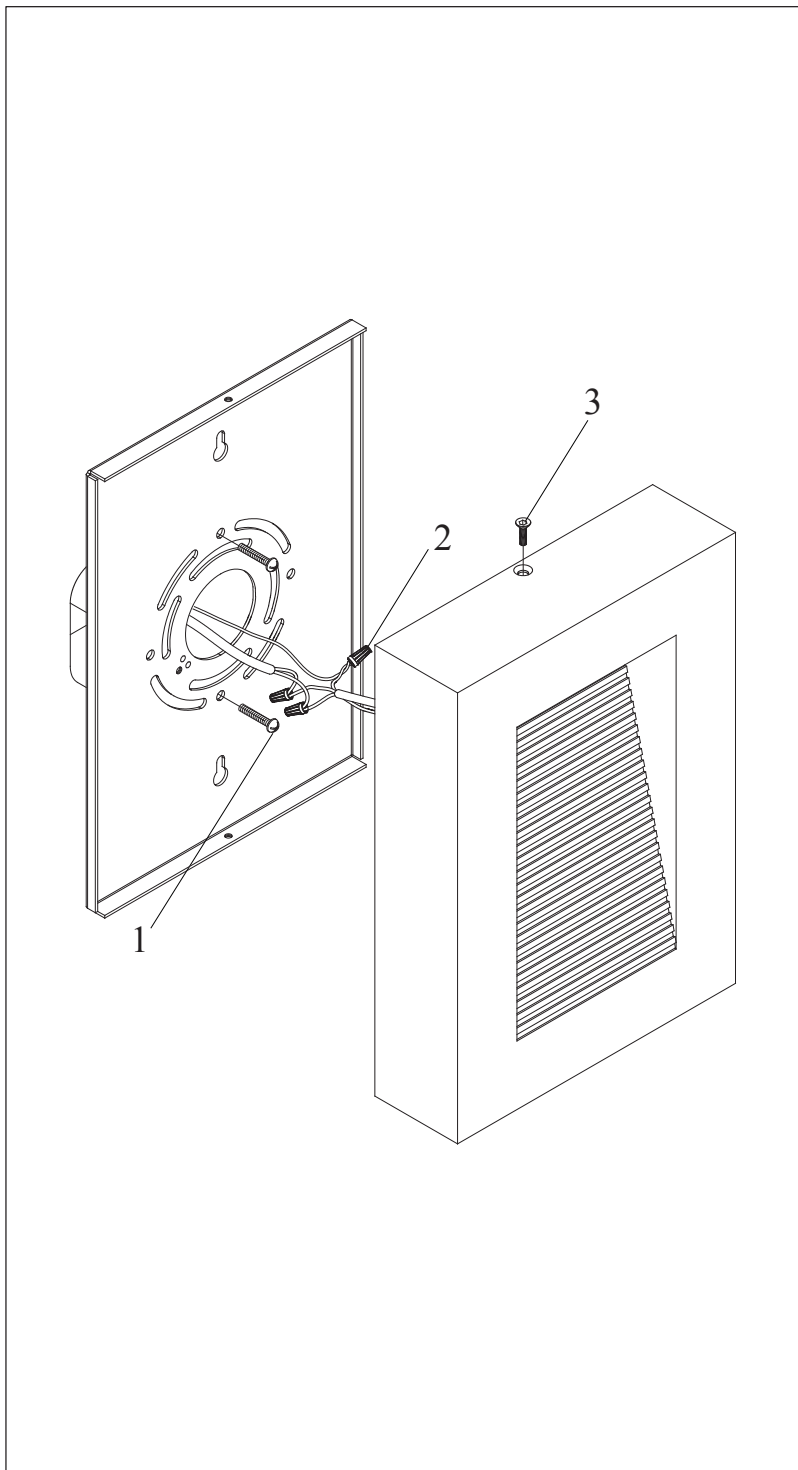

1.)

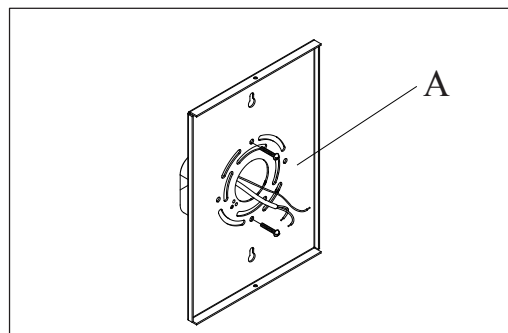

Step.1: Install Mounting bracket(A) to outlet box.

2.)

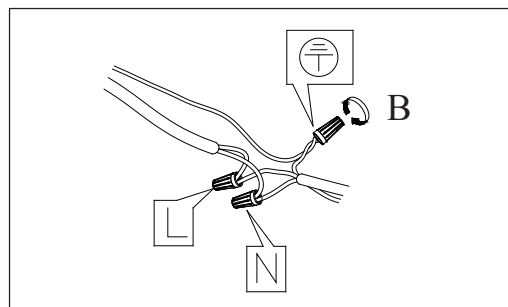

Step.2: Wire fixture to wires in outlet box.
Green/Copper wire is for Ground.

3.)

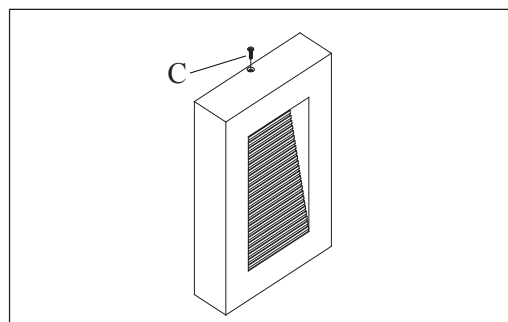

Step.3: Caulk around fixture with outdoor silicone sealant to prevent water intrusion. Leave a small gap at the bottom to allow moisture to escape. Install fixture to mounting bracket (A) and tighten mounting screws (C).

Cleaning & Care:

Clean with soft cloth and a mild detergent.
Do not use abrasive cleaner.