

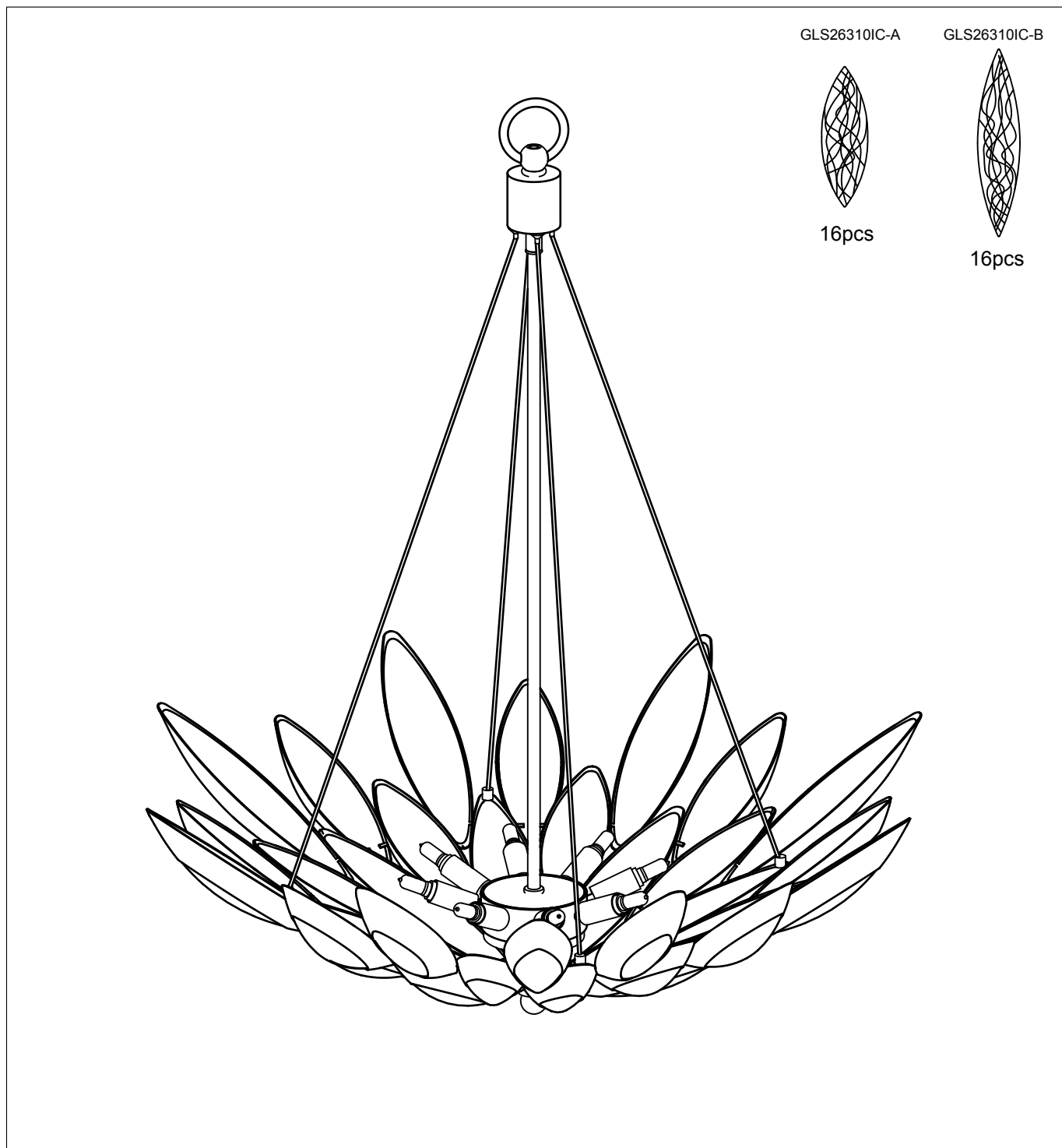

PRODUCT NAME: LOTUS

ITEM NUMBER: 26315ICBRB

Please consult your electrician for hanging fixture and wiring.



G9 8X40W (Bulb included)

IMPORTANT: Turn off the power at the main fuse or circuit breaker box before starting installation.

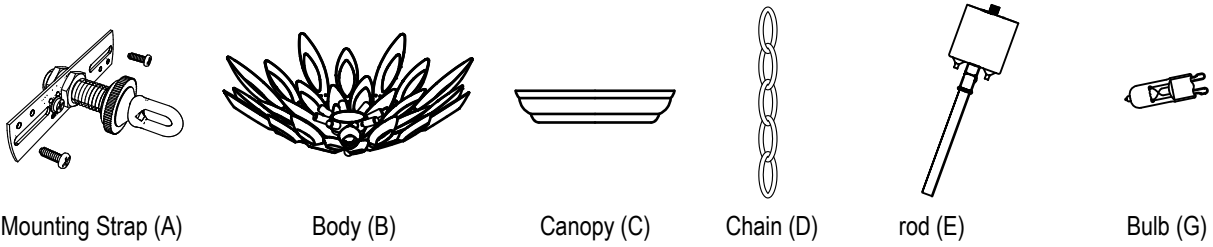

Locate all hardware & components before discarding packaging

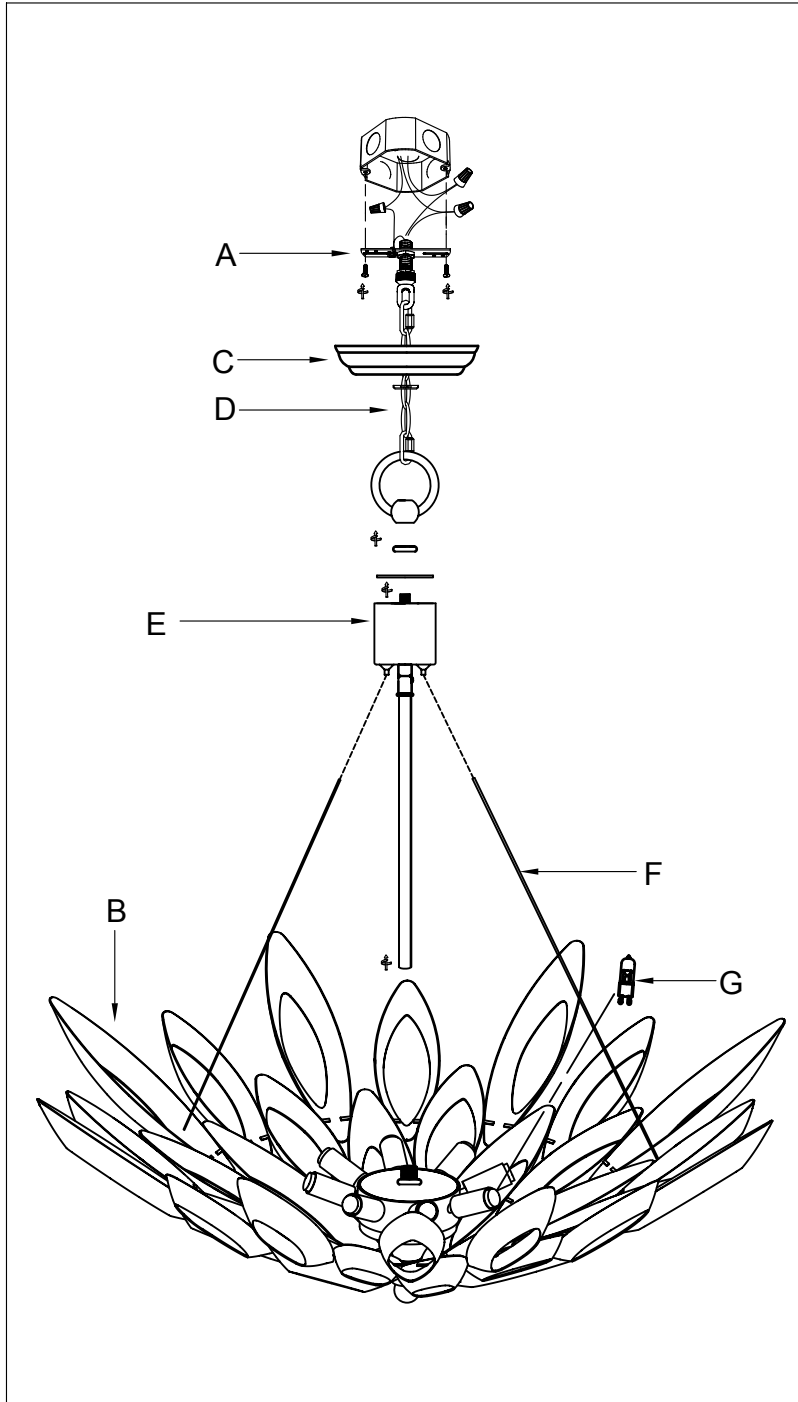

Cleaning & Care:
Clean with soft cloth and a mild detergent.
Do not use abrasive cleaner.

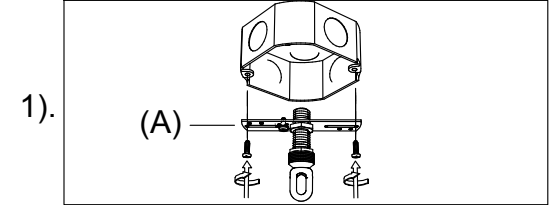

Step.1: Remove mounting bracket (A) from fixture and install to electrical box.

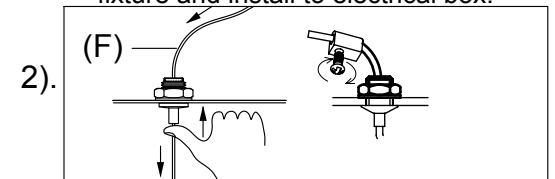

Step.2: Press the wire restraint to adjust the desired length of cable. Secure the cables.

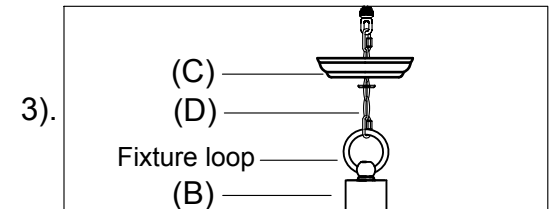

Step.3: Install fixture loop. Connect chain (D) to fixture loop and screw collar loop with key link. Thread fixture wire through the chain (D) into outlet box.

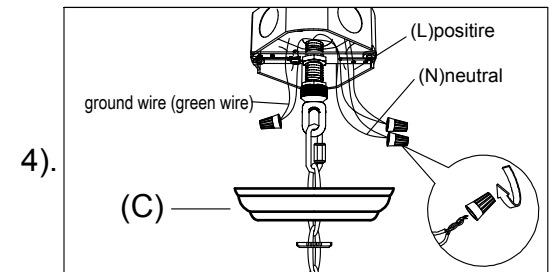

Step.4: Wire fixture to wires in outlet box. Green wire is for Ground.

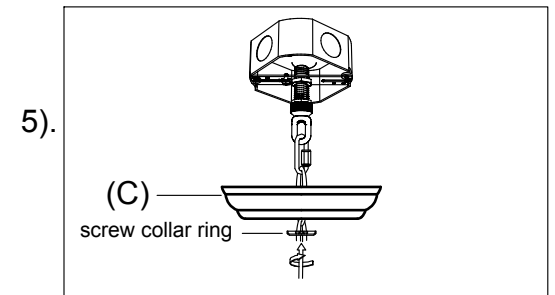

Step.5: Raise Canopy (C) to ceiling and secure with screw collar ring.