

Type _____
 Project _____
 Catalog No. _____
 Lamp/Wattage _____

NTH-160 / NTH-161 / NTH-162 Track Mounted Pendant Adapters

Lamp: 60W Candelabra, 100W Medium Base
 40W G9 Halogen

PRODUCT DESCRIPTION

Track pendant with 8'-6" pendant cord and line voltage socket. Cord is field adjustable to any length.

Socket Assembly

Top neck of porcelain socket held by a die-cast ring. Accepts custom glass or decorative element with 7/8" opening (ordered separately). Porcelain socket rated at 150°C maximum.

Cord

Insulated wire rated min. 200°C, 300V.

Lamp

NTH-160 - 60W Candelabra max. (not included)
 NTH-161 - 100W Medium Base max. (not included)
 NTH-162 - 40W G9 Halogen max. (included)

Lamp Shield

Protected frosted lamp shield included with NTH-162.

Finishes

Black, Silver, or White painted finishes.

Contact Head Assembly

Three copper contacts mounted in high heat rated plastic housing.

One/Two Circuit Conversion

Positive contact (opposite neutral and ground contacts) is preset to "down" position at factory but may be raised to the higher position to install onto the second circuit of Nora Lighting NT-2300 series two-circuit track.

Labels and Listings

UL and cUL Listed

DIMENSIONS

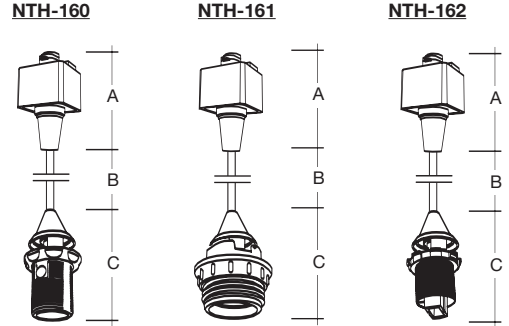

Dimensions	NTH-160	NTH-161	NTH-162
A: Track Adapter	2-3/4"	2-3/4"	2-3/4"
B: Cord Length	8'-6"	8'-6"	8'-6"
C: Socket Length	2-1/2"	2-7/8"	2-1/2"



Create a complete fixture/trim catalog number: Example: NTH-162B / NRS80-480BR

Track Pendant - select one box from each column

Catalog No.	Lamp	Finish
NTH	Candelabra (160)	B
	Medium Base (161)	S
	G9 Halogen (162)	W

Finishes: B = Black, S = Silver, W = White

Glass - select Catalog No. and Finish

Catalog No.	Finish						
NG-80	NRS80-411	NRS80-463	NRS80-476	NRS80-492	AM	FR	S
NRS70-601	NRS80-451	NRS80-465	NRS80-477	NRS80-493	AQ	G	SA
NRS70-602	NRS80-452	NRS80-466	NRS80-480	NRS82-201	AY	GBR	SN
NRS70-603	NRS80-453	NRS80-467	NRS80-481	NRS82-202	BB	GR	TC
NRS70-604	NRS80-454	NRS80-468	NRS80-482	NRS82-203	BE	MA	W
NRS70-605	NRS80-455	NRS80-469	NRS80-483	NRS82-204	BG	MG	WV
NRS70-606	NRS80-456	NRS80-470	NRS80-484		BR	O	Y
NRS70-607	NRS80-457	NRS80-471	NRS80-485		BU	P	
NRS70-608	NRS80-458	NRS80-472	NRS80-486		BZ	PK	
NRS80-204	NRS80-459	NRS80-473	NRS80-487		CF	R	
NRS80-401	NRS80-461	NRS80-474	NRS80-490		CL	RB	
NRS80-407	NRS80-462	NRS80-475	NRS80-491		DB	RF	

Finishes:

AM = Amber, AQ = Aqua, AY = Amethyst, BB = Bamboo Brown, BE = Beige, BG = Bluish Green, BR = Brown, BU = Blue, BZ = Bronze, CF = Confetti, CL = Clear, DB = Dark Blue, FR = Frost, G = Gold, GBR = Granite Brown, GR = Green, MA = Marble, MG = Magma, O = Orange, P = Purple, PK = Peacock Blue, R = Red, RB = Red Burnt, RF = Red Fire, S = Silver, SA = Salmon, SN = Sun, TC = Tri-Color, W = White, WV = Wave, Y = Yellow

NTH-160 / NTH-161 / NTH-162 Compatible Glass

NG-80 Cylindrical Glass

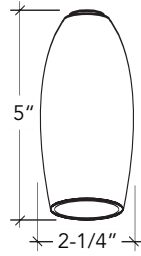

Glass Finish: Amber (A), Blue (B), Green (G), White (W)
 Lamp: 60W E12 Candelabra
 Glass Diameter: 2-1/4" Glass Height: 5"

NRS70-604 Flare Angoor Beaded

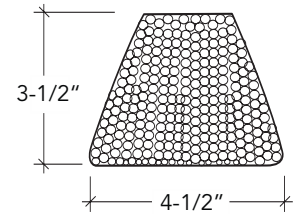

Glass Finishes: Amber (AM), Aqua (AQ), Clear (CL), Red (R)
 Lamp: 40W G9 Halogen
 Glass Diameter: 4-1/2" Glass Height: 3-1/2"

NRS70-601 Oval Angoor Beaded

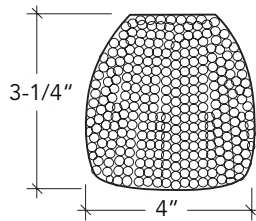
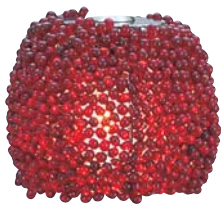

Glass Finish: Amber (AM), Aqua (AQ), Clear (CL), Red (R)
 Lamp: 40W G9 Halogen
 Glass Diameter: 4" Glass Height: 3-1/4"

NRS70-605 Hourglass Angoor Beaded

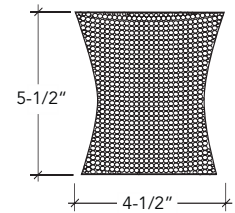

Glass Finishes: Amber (AM), Bluish Green (BG), Clear (CL), Red (R)
 Lamp: 60W E12 Candelabra, 40W G9 Halogen
 Glass Diameter: 4-1/2" Glass Height: 5-1/2"

NRS70-602 Cylinder Angoor Beaded

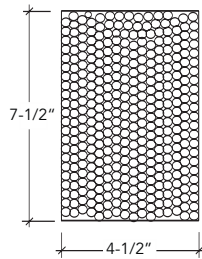

Glass Finish: Amber (AM), Aqua (AQ), Clear (CL), Red (R)
 Lamp: 100W Medium Base, 60W E12 Candelabra, 40W G9 Halogen
 Glass Diameter: 4-1/2" Glass Height: 7-1/2"

NRS70-606 Tapered Beaded

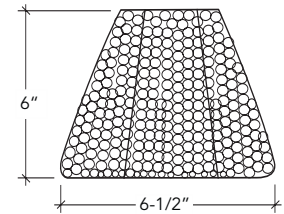

Glass Finishes: Amber (AM), Bluish Green (BG), Red (R), Silver (S)
 Lamp: 100W Medium Base, 60W E12 Candelabra, 40W G9 Halogen
 Glass Diameter: 6-1/2" Glass Height: 6"

NRS70-603 Round Angoor Beaded

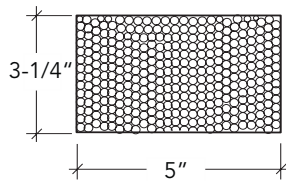

Glass Finishes: Amber (AM), Aqua (AQ), Clear (CL), Red (R)
 Lamp: 40W G9 Halogen
 Glass Diameter: 5" Glass Height: 3-1/4"

NRS70-607 Bell Beaded

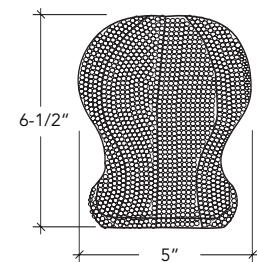

Glass Finishes: Amber (AM), Bluish Green (BG), Red (R), Silver (S)
 Lamp: 100W Medium Base, 60W E12 Candelabra, 40W G9 Halogen
 Glass Diameter: 5" Glass Height: 6-1/2"

NTH-160 / NTH-161 / NTH-162 Compatible Glass

NRS70-608 Empire Beaded

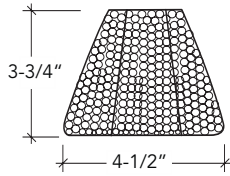

Glass Finishes: Amber (AM), Bluish Green (BG), Red (R), Silver (S)
 Lamp: 40W G9 Halogen
 Glass Diameter: 4-1/2" Glass Height: 3-3/4"

NRS80-411 Mega Ice Cube

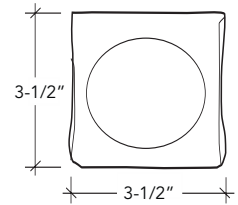

Glass Finish: Amber (AM), Aqua (AQ), Amethyst (AY), Blue (BU), Clear (CL)
 Lamp: 40W G9 Halogen
 Glass Height: 3-1/2" Glass Length: 3-1/2"

NRS80-204 Swift Glass

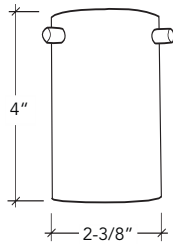

Glass Finishes: Amber (AM), Frost (FR), Orange (O)
 Lamp: 40W G9 Halogen
 Glass Height: 2-3/8" Glass Length: 4"

NRS80-451 Neptune

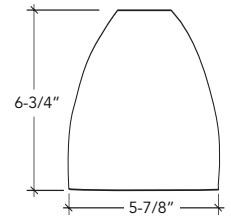

Glass Finishes: Confetti (CF), Tri-Color (TC), Wave (WV)
 Lamp: 100W Medium Base, 60W E12 Candelabra, 40W G9 Halogen
 Glass Diameter: 5-7/8" Glass Height: 6-3/4"

NRS80-401 Ice Cube

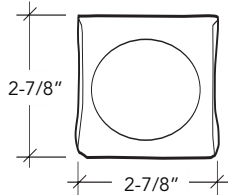

Glass Finishes: Amber (AM), Aqua (AQ), Amethyst (AY), Blue (BU), Clear (CL)
 Lamp: 40W G9 Halogen
 Glass Height: 2-7/8" Glass Length: 2-7/8"

NRS80-452 Andromeda

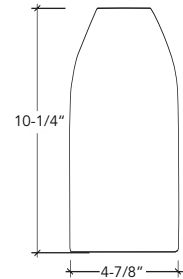

Glass Finishes: Frost (FR), Green (GR), Peacock Blue (PK), Red Fire (RF), Sun (SN)
 Lamp: 100W Medium Base, 60W E12 Candelabra, 40W G9 Halogen
 Glass Diameter: 4-7/8" Glass Height: 10-1/4"

NRS80-407 Sophia

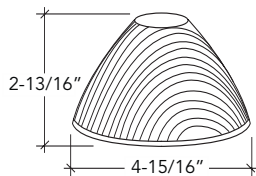

Glass Finish: Dichroic
 Lamp: 40W G9 Halogen
 Glass Diameter: 4-15/16" Glass Height: 2-13/16"

NRS80-453 Sol

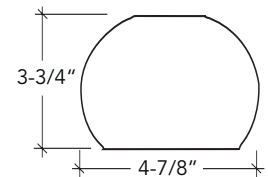

Glass Finishes: Blue (BU), Red Fire (RF)
 Lamp: 40W G9 Halogen
 Glass Diameter: 4-7/8" Glass Height: 3-3/4"

NTH-160 / NTH-161 / NTH-162 Compatible Glass

NRS80-454 Orion

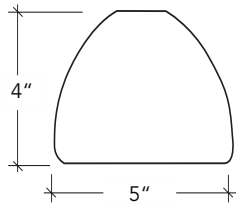

Glass Finishes: Blue (BU), Orange (O), White (W), Yellow (Y)
 Lamp: 40W G9 Halogen
 Glass Diameter: 5" Glass Height: 4"

NRS80-458 Roba-M

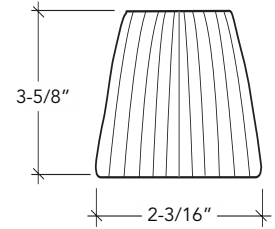

Glass Finishes: Blue (BU), Frost (FR)
 Lamp: 40W G9 Halogen
 Glass Diameter: 2-13/16" Glass Height: 3-5/8"

NRS80-455 Venus

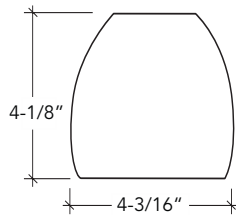

Glass Finishes: Blue (BU), White (W), Yellow (Y)
 Lamp: 40W G9 Halogen
 Glass Diameter: 4-3/16" Glass Height: 4-1/8"

NRS80-459 Roba-L

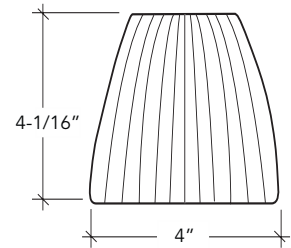

Glass Finishes: Blue (BU), Frost (FR)
 Lamp: 40W G9 Halogen
 Glass Diameter: 4" Glass Height: 4-1/16"

NRS80-456 Mercure

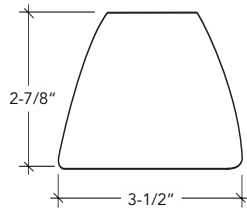

Glass Finishes: Blue (BU), Clear (CL), Orange (O)
 Lamp: 40W G9 Halogen
 Glass Diameter: 3-1/2" Glass Height: 2-7/8"

NRS80-461 Jupiter

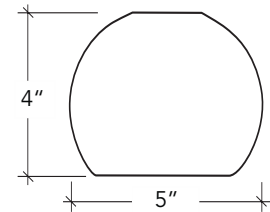

Glass Finishes: Blue (BU), White (W), Yellow (Y)
 Lamp: 40W G9 Halogen
 Glass Diameter: 5" Glass Height: 4"

NRS80-457 Saturn

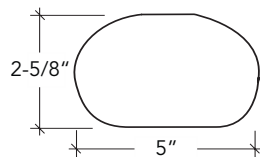

Glass Finish: Blue (BU), White (W)
 Lamp: 40W G9 Halogen
 Glass Diameter: 5" Glass Height: 2-5/8"

NRS80-462 Casie

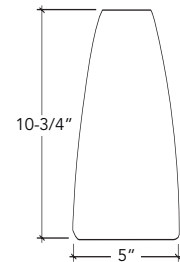

Glass Finishes: Blue (BU), Orange (O), Purple (P), White (W)
 Lamp: 60W E12 Candelabra, 40W G9 Halogen
 Glass Diameter: 5" Glass Height: 10-3/4"

NTH-160 / NTH-161 / NTH-162 Compatible Glass

NRS80-463 Reflections

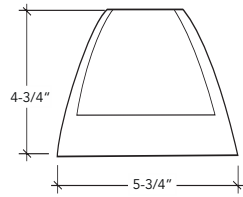

Glass Finish: Mirror
 Lamp: 40W G9 Halogen
 Glass Diameter: 5-3/4" Glass Height: 4-3/4"

NRS80-468 Duo Cube

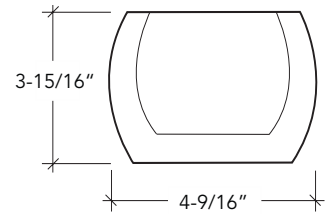

Glass Finishes: Aqua (AQ), Amethyst (AY), Blue (BU), Bronze (BZ), Clear (CL), Red (R)
 Lamp: 40W G9 Halogen
 Glass Diameter: 4-9/16" Glass Height: 3-15/16"

NRS80-465 Tanner

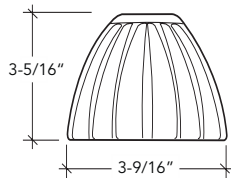

Glass Finishes: Gold (G), Silver (S)
 Lamp: 40W G9 Halogen
 Glass Diameter: 3-9/16" Glass Height: 3-5/16"

NRS80-469 Duo Dome

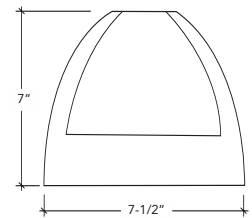

Glass Finishes: Aqua (AQ), Amethyst (AY), Blue (BU), Bronze (BZ), Red (R)
 Lamp: 60W E12 Candelabra, 40W G9 Halogen
 Glass Diameter: 7-1/2" Glass Height: 7"

NRS80-466 Elvin

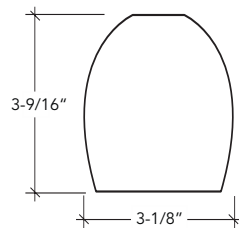

Glass Finishes: Amber (AM), Blue (BU), Red (R), White (W)
 Lamp: 40W G9 Halogen
 Glass Diameter: 3-1/8" Glass Height: 3-9/16"

NRS80-470 Feather

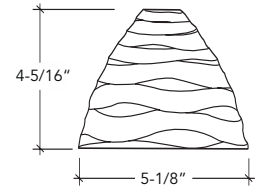

Glass Finish: White on White
 Lamp: 60W E12 Candelabra, 40W G9 Halogen
 Glass Diameter: 5-1/8" Glass Height: 4-5/16"

NRS80-467 Bonita Cube

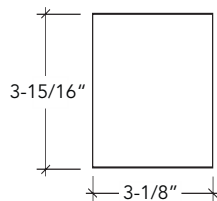

Glass Finish: Amber (AM), Blue (BU), Red (R), White (W)
 Lamp: 40W G9 Halogen
 Glass Height: 3-15/16" Glass Length: 3-1/8"

NRS80-471 Ferus

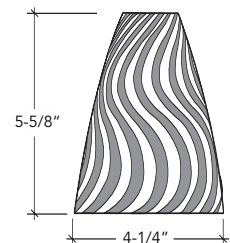

Glass Finish: Black on White
 Lamp: 100W Medium Base, 60W E12 Candelabra, 40W G9 Halogen
 Glass Diameter: 4-1/4" Glass Height: 5-5/8"

NTH-160 / NTH-161 / NTH-162 Compatible Glass

NRS80-472 Sean

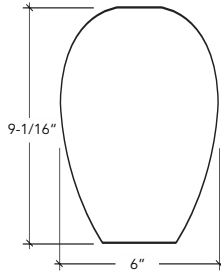

Glass Finish: Magna
Lamp: 100W Medium Base, 60W E12 Candelabra, 40W G9 Halogen
Glass Diameter: 6" Glass Height: 9-1/16"

NRS80-476 Grant

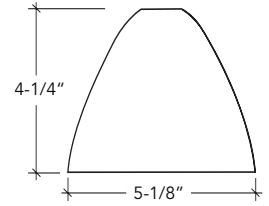

Glass Finishes: Amber (AM), Blue (BU), Bronze (BZ), Green (GR), Red (R)
Lamp: 60W E12 Candelabra, 40W G9 Halogen
Glass Diameter: 5-1/8" Glass Height: 4-1/4"

NRS80-473 Cocoon

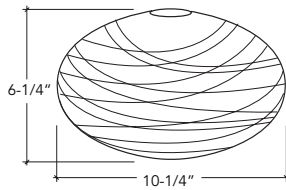

Glass Finish: White
Lamp: 100W Medium Base, 60W E12 Candelabra, 40W G9 Halogen
Glass Diameter: 10-1/4" Glass Height: 6-1/4"

NRS80-477 Bolla

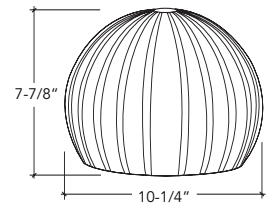

Glass Finish: White
Lamp: 100W Medium Base, 60W E12 Candelabra, 40W G9 Halogen
Glass Diameter: 10-1/4" Glass Height: 7-7/8"

NRS80-474 Eric

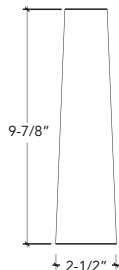

Glass Finishes: Amber (AM), White (W)
Lamp: 60W E12 Candelabra, 40W G9 Halogen
Glass Diameter: 2-1/2" Glass Height: 9-7/8"

NRS80-480 Rain

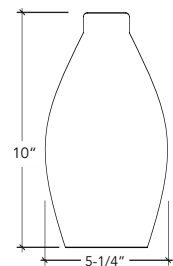

Glass Finishes: Brown (BR), Blue (BU), Green (GR), Red (R), White (W)
Lamp: 100W Medium Base, 60W E12 Candelabra, 40W G9 Halogen
Glass Diameter: 5-1/4" Glass Height: 10"

NRS80-475 Bonita Cone

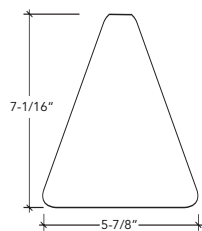
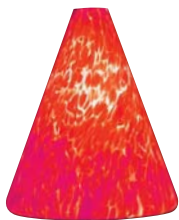

Glass Finishes: Amber (AM), Magma Cone (MG), Red (R), White (W)
Lamp: 100W Medium Base, 60W E12 Candelabra, 40W G9 Halogen
Glass Diameter: 5-7/8" Glass Height: 7-1/16"

NRS80-481 Agua

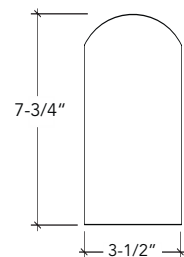

Glass Finishes: Beige (BE), Blue (BU), Marble (MA), Red Fire (RF)
Lamp: 100W Medium Base, 60W E12 Candelabra, 40W G9 Halogen
Glass Diameter: 3-1/2" Glass Height: 7-3/4"

NTH-160 / NTH-161 / NTH-162 Compatible Glass

NRS80-482 Tear Drop

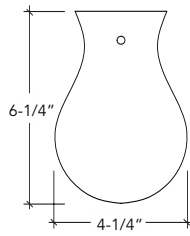

Glass Finish: Beige (BE), Deep Blue (DB), Granite Brown (GBR), Salmon (SA), White (W)
 Lamp: 60W E12 Candelabra, 40W G9 Halogen
 Glass Diameter: 4-1/4" Glass Height: 6-1/4"

NRS80-486 Pond Closed

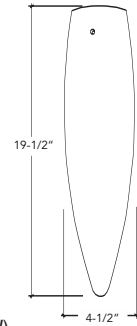

Glass Finishes: Beige (BE), Blue (BU), Red (R), White (W)
 Lamp: 100W Medium Base, 60W E12 Candelabra, 40W G9 Halogen
 Glass Diameter: 4-1/2" Glass Height: 19-1/2"

NRS80-483 Pool

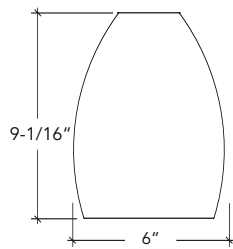

Glass Finishes: Beige (BE), Blue (BU), Green (GR), Red Fire (RF), White (W)
 Lamp: 100W Medium Base, 60W E12 Candelabra, 40W G9 Halogen
 Glass Diameter: 6" Glass Height: 9-1/16"

NRS80-487 Pond

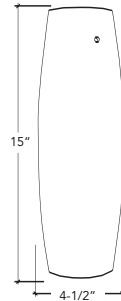

Glass Finishes: Beige (BE), Blue (BU), Red (R), White (W)
 Lamp: 100W Medium Base, 60W E12 Candelabra, 40W G9 Halogen
 Glass Diameter: 4-1/2" Glass Height: 15"

NRS80-484 River

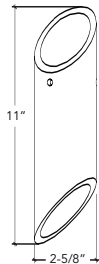

Glass Finishes: Beige (BE), Brown (BR), Blue (BU), Granite Brown (GBR), Red Fire (RF), White (W)
 Lamp: 60W E12 Candelabra, 40W G9 Halogen
 Glass Diameter: 2-5/8" Glass Height: 11"

NRS80-490 Trumpet

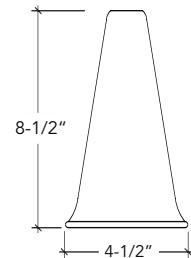

Glass Finishes: Amber (AM), Blue (BU), Red (R), White (W)
 Lamp: 60W E12 Candelabra, 40W G9 Halogen
 Glass Diameter: 4-1/2" Glass Height: 8-1/2"

NRS80-485 Tsunami

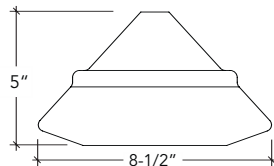
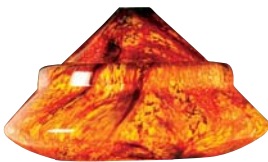

Glass Finishes: Bamboo Brown (BB), Blue (BU), Red Fire (RF), White (W)
 Lamp: 60W E12 Candelabra, 40W G9 Halogen
 Glass Diameter: 8-1/2" Glass Height: 5"

NRS80-491 Snow

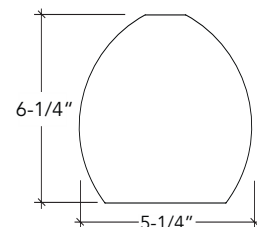

Glass Finishes: Amber (AM), Blue (BU), Red (R), White (W)
 Lamp: 100W Medium Base, 60W E12 Candelabra, 40W G9 Halogen
 Glass Diameter: 5-1/4" Glass Height: 6-1/4"

NTH-160 / NTH-161 / NTH-162 Compatible Glass

NRS80-492 Rain Fall

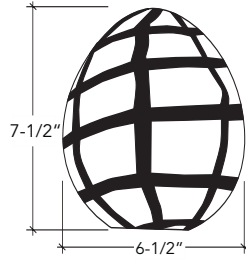

Glass Finishes: Amber (AM), Blue (BU), White (W)
 Lamp: 100W Medium Base, 60W E12 Candelabra, 40W G9 Halogen
 Glass Diameter: 6-1/2" Glass Height: 7-1/2"

NRS82-203 Chicago

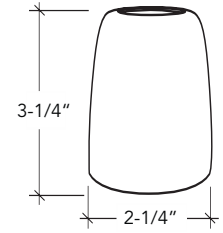

Glass Finishes: Amber (AM), Brown (BR), Blue (BU), Red (R), White (W)
 Lamp: 40W G9 Halogen
 Glass Diameter: 2-1/4" Glass Height: 3-1/4"

NRS80-493 Water Fall

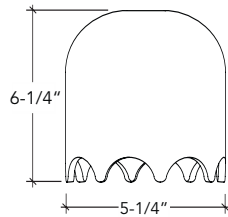

Glass Finish: Amber (AM), Blue (BU), Red Burnt (RB), White (W)
 Lamp: 100W Medium Base, 60W E12 Candelabra, 40W G9 Halogen
 Glass Diameter: 5-1/4" Glass Height: 6-1/4"

NRS82-204 Madeleine

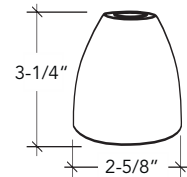

Glass Finishes: Amber (AM), Brown (BR), Blue (BU), Red (R), White (W)
 Lamp: 40W G9 Halogen
 Glass Diameter: 2-5/8" Glass Height: 3-1/4"

NRS82-201 Paris

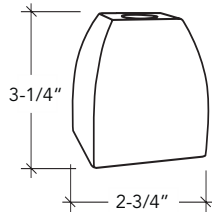

Glass Finishes: Amber (AM), Brown (BR), Blue (BU), Red (R), White (W)
 Lamp: 40W G9 Halogen
 Glass Height: 3-1/4" Glass Length: 2-3/4"

NRS82-202 Monte

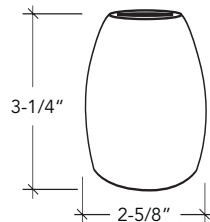

Glass Finishes: Amber (AM), Brown (BR), Blue (BU), Red (R), White (W)
 Lamp: 40W G9 Halogen
 Glass Diameter: 2-5/8" Glass Height: 3-1/4"