

SAFETY INFORMATION

Please read and understand this entire manual before attempting to assemble, install or operate the product.

WARNING

- RISK OF ELECTRIC SHOCK - Before beginning installation, turn off electricity at the circuit breaker box or the main fuse box.

CAUTION

- For your safety, read instructions completely before beginning installation.
- If in doubt about electrical installation, consult a licensed electrician.

TOOLS REQUIRED

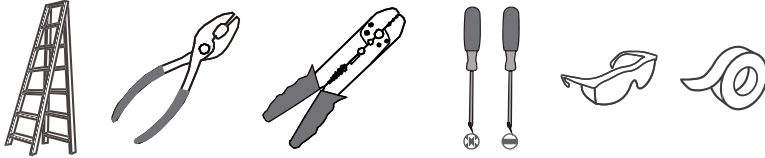

Ratings	120Vac, 60Hz	
	Model No.	Wattage
	PCOH2932BN	71W
	PCOH2932OI	71W

CARE AND MAINTENANCE

- Wipe clean using soft, dry cloth or static duster. Always avoid using harsh chemicals and abrasives to clean fixture as they may damage the finish.

If you need further assistance call Quozel Customer Care at 1-800-645-3184 (9:00am - 5:00pm EST), or visit us on-line at www.quezel.com.

PACKAGE CONTENTS

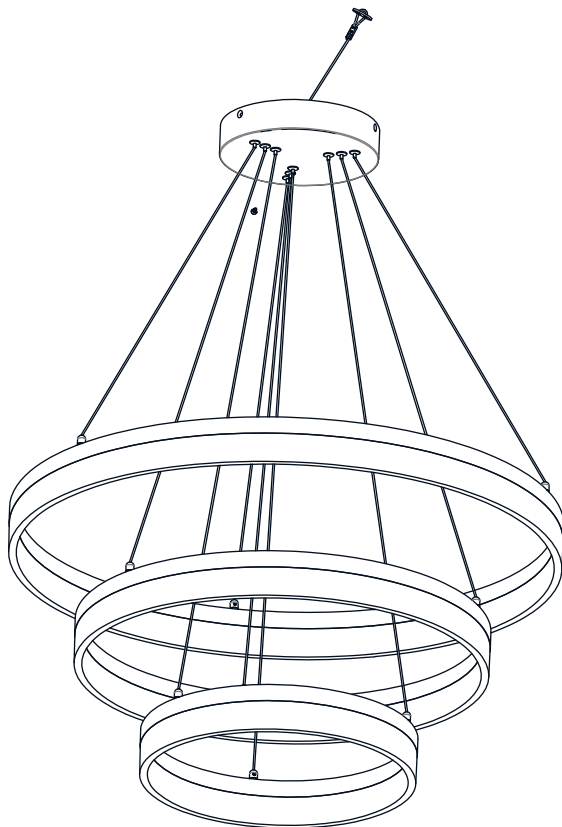

A Fixture Body
x 1

MOUNTING HARDWARE

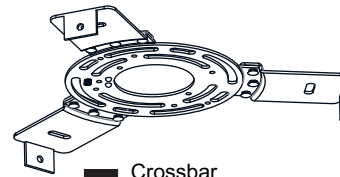

AA Crossbar
x 1



BB Mounting Screw
x 3

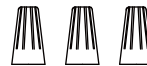

CC Wire Connector
x 3

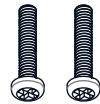

DD Outlet Box Screw
x 2

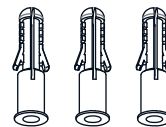

EE Wall Anchor
x 3

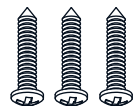

FF Screw
x 3

INSTALLATION

1 Adjust Cord Length: Fixture Height Adjustable 8.5" to 98.25"

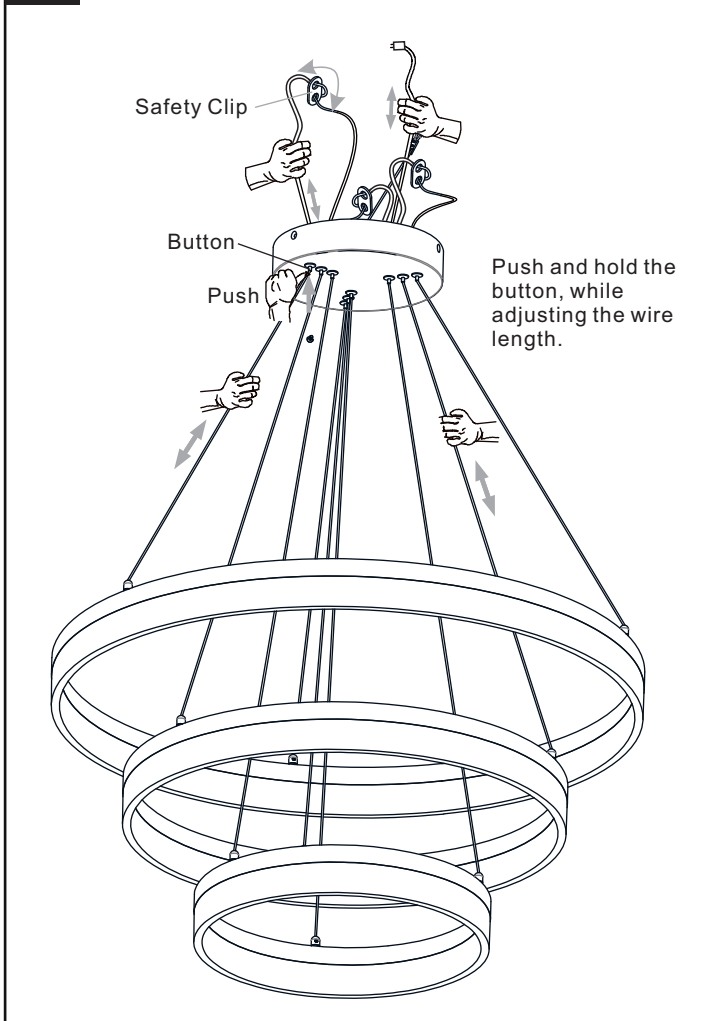

2 Install Crossbar

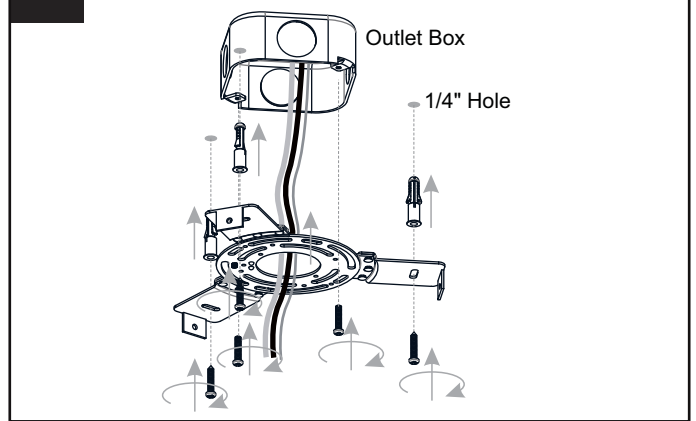

3 Install Crossbar

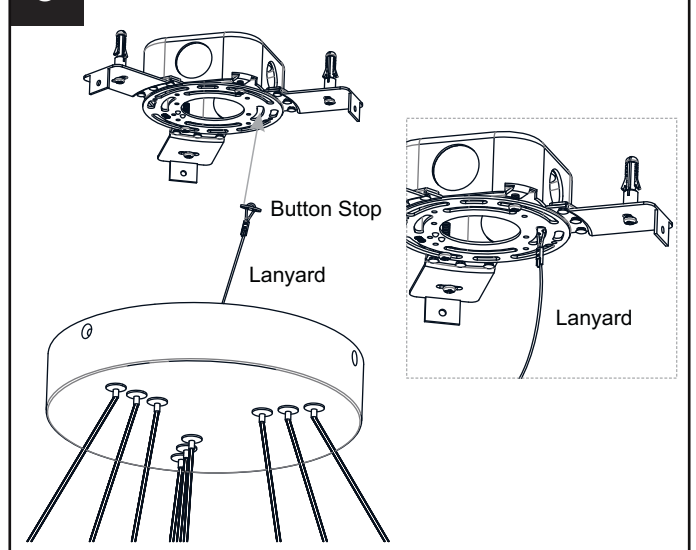

4 Connect Supply Wires to Driver

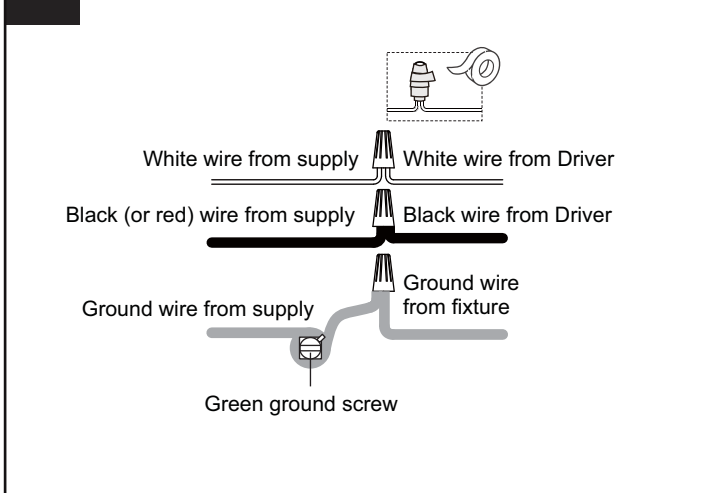

5 Install Ceiling Canopy to Crossbar

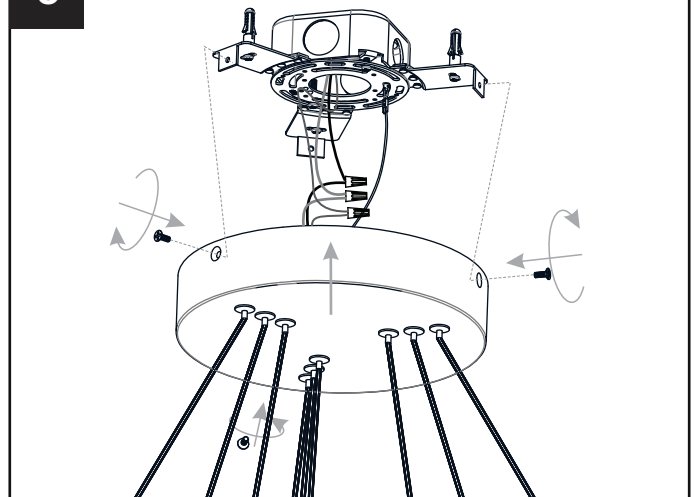

Your installation is now complete! Restore electricity and save this sheet for future reference.