

Please go to www.quoise.com for product cleaning tips. Go to the **Care + Maintenance** selection.

Tools Required: Flathead screwdriver, Phillips screwdriver, pliers, wire cutters, wire strippers, electrical tape, safety glasses.

Light Source: (4) A19 Medium Base Bulbs 100W Maximum, Medium Base Vintage Bulbs are recommended, bulbs not included.

Estimated Assembly Time: 20-30 minutes

Preparation: Identify and inspect all parts before beginning installation. Check package content list and diagrams below to ensure all parts are present. If any parts are missing or damaged, do not attempt to assemble, install, or operate the fixture. Contact your original place of purchase.

⚠ Warnings and Cautions

Turn off electricity at circuit breaker or main fuse box before installation. Consult a licensed electrician if in doubt.

These instructions are provided for your safety. It is very important you read them completely before installing the fixture. We strongly recommend that a licensed, professional electrician perform the installation.

Disconnect fixture from power source before replacing bulbs. Make sure bulbs are given sufficient time to cool before removal.

Package Contents

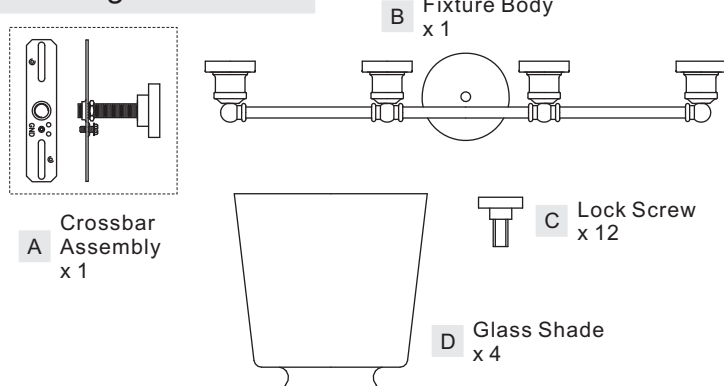

STEP 1 - Install the Crossbar Assembly to the junction box

- A. Attach the Crossbar Assembly (A) to the outlet box with the head of green ground screw facing you. Secure it with outlet box screws (not included), tighten until snug.

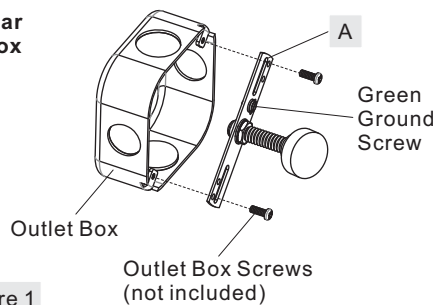

Figure 1

STEP 2 - Test fitting the backplate to the Crossbar Assembly

- A. Adjust the hex nut and lock washer underside of the crossbar to the middle of the nipple.
- B. Remove the mounting ball from the nipple. Place the backplate and Fixture Body (B) over the nipple against the wall to determine the correct position of the nipple. Thread the mounting ball onto the nipple. Adjust the nipple to allow the backplate to rest against the wall when held in place by the mounting ball.
- C. Remove the mounting ball and the Fixture Body (B). Tighten the lock washer and the hex nut against the crossbar to secure in place.

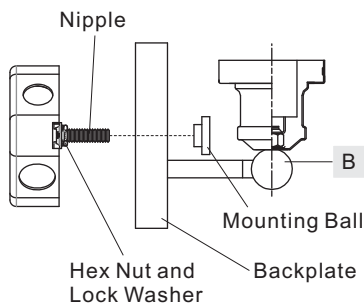

Figure 2

STEP 3 - Wire Connections

- A. Wrap bare or green ground wire around green ground screw on the crossbar, no less than 2 inches from the end of the wire. Tighten the green ground screw.
- B. Use standard wire connectors (not included) to make all wire connections. Twist connectors until wires are tightly joined together. Wrap each connection with approved electrical tape and carefully stuff all the connected wires into the Outlet Box.

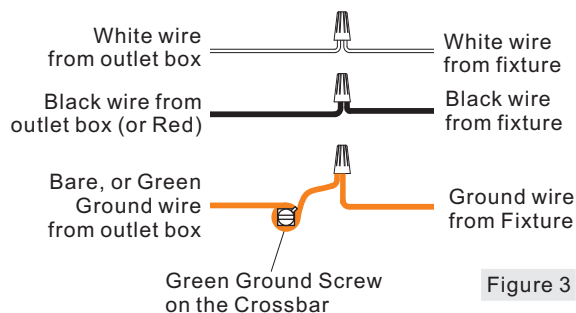

Figure 3

STEP 4 - Install the Fixture Body

- A. Place the backplate of the Fixture Body (B) onto the nipple and secure with previously removed mounting ball. Hand tighten until snug.

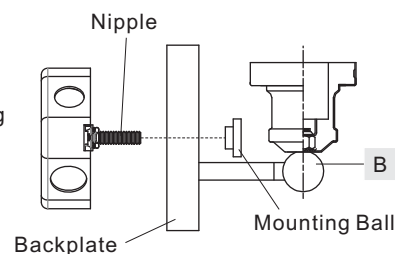

Figure 4

STEP 5 - Install Glass Shades and Bulbs

- A. Place the Glass Shade (D) into the socket cup properly. Thread Lock Screws (C) onto socket cup to engage the neck of the Glass Shade (D).
- B. Insert bulbs onto sockets and screw snugly into place.

Your fixture is now assembled and ready to use. Enjoy!

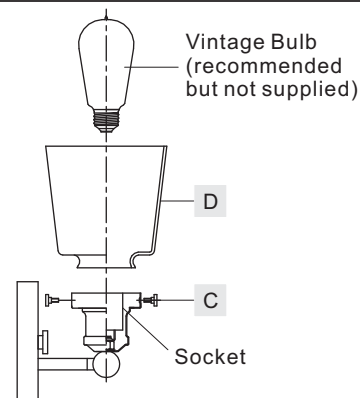

Figure 5