

RENAISSANCE 3785- \_\_ \_\_ TK

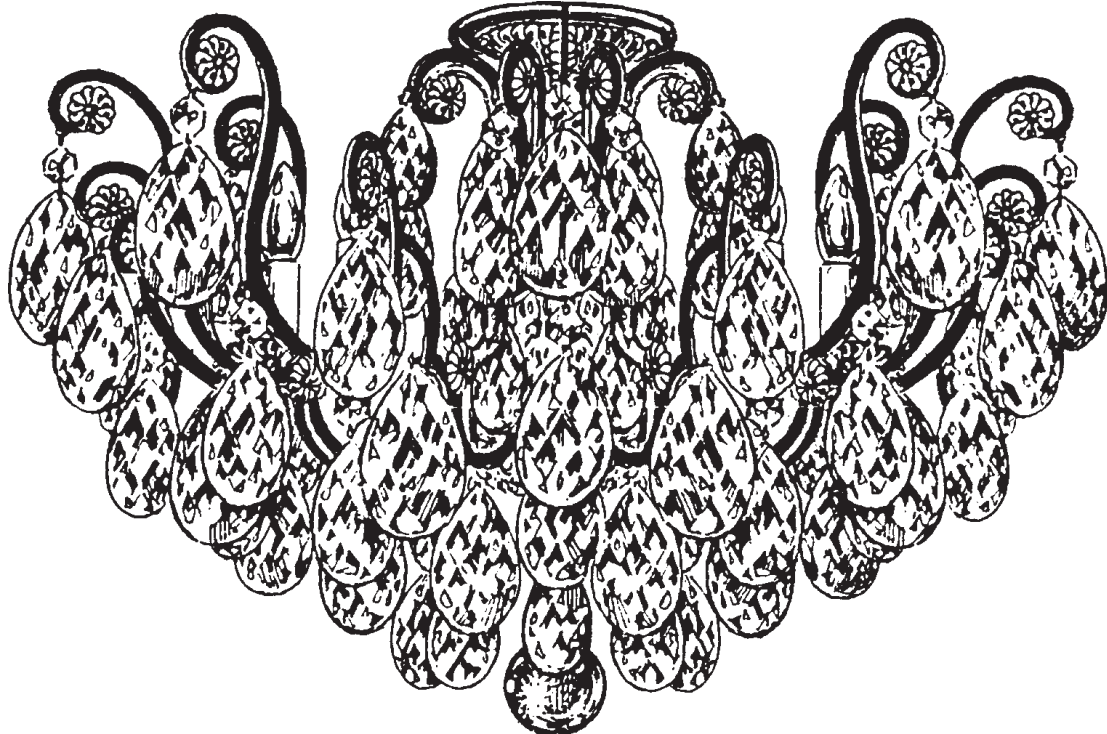

**T**HIS DESIGN IS THE PROPRIETARY TRADE DRESS/TRADemark OF SWAROVSKI LIGHTING, LTD.

8 Lights  
Diameter: 26"  
Body Length: 18"  
Hanging Weight: 30 lbs.



**SCHONBEK®**



**SCHONBEK®**

MAX <u>60</u> W		110-120 V						

All electrical components must be installed by a licensed electrician in accordance with the National Electric Code and the appropriate local electrical codes.

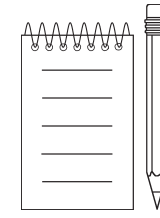
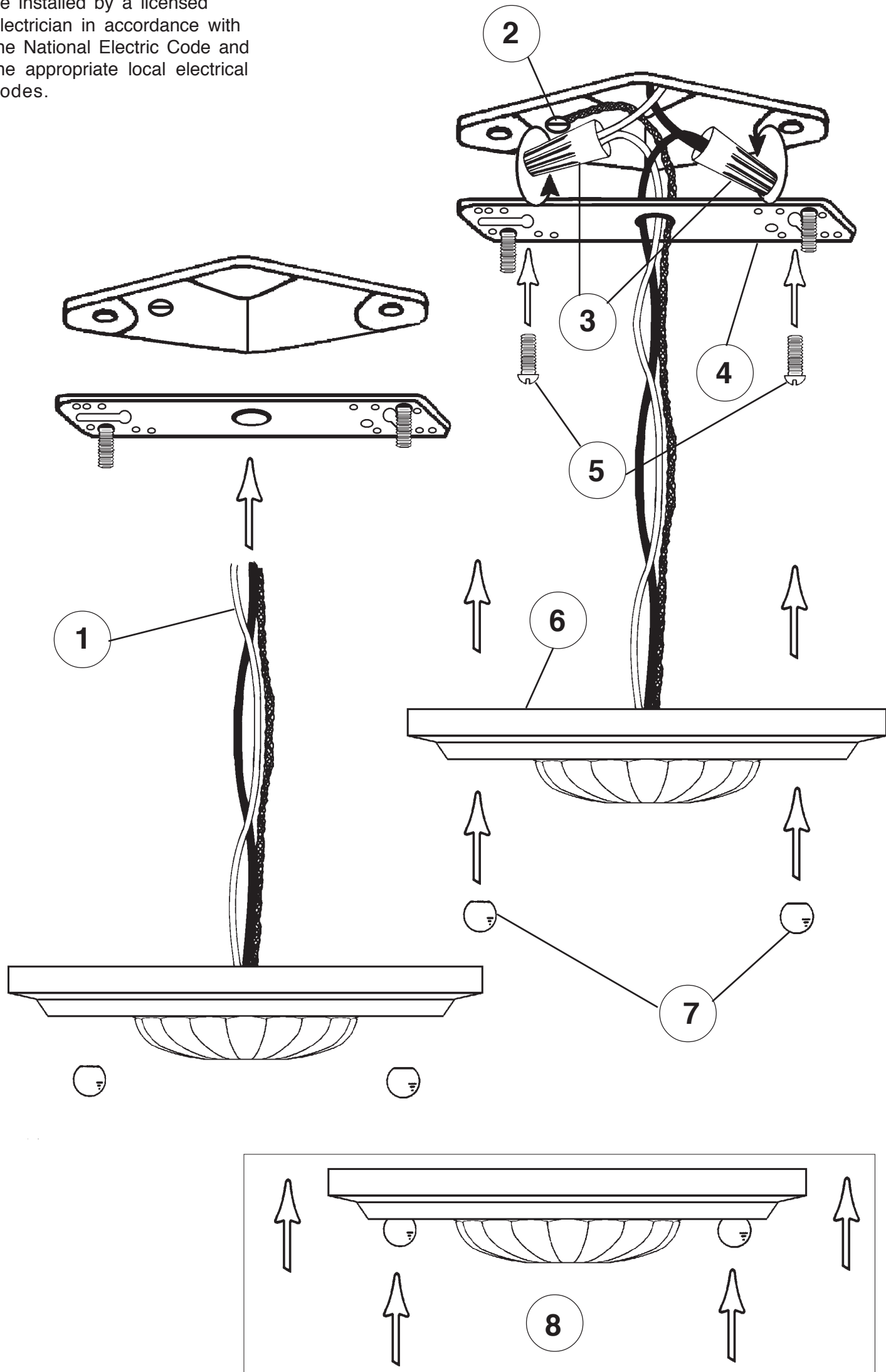

**Crystal Set #3 in Black**

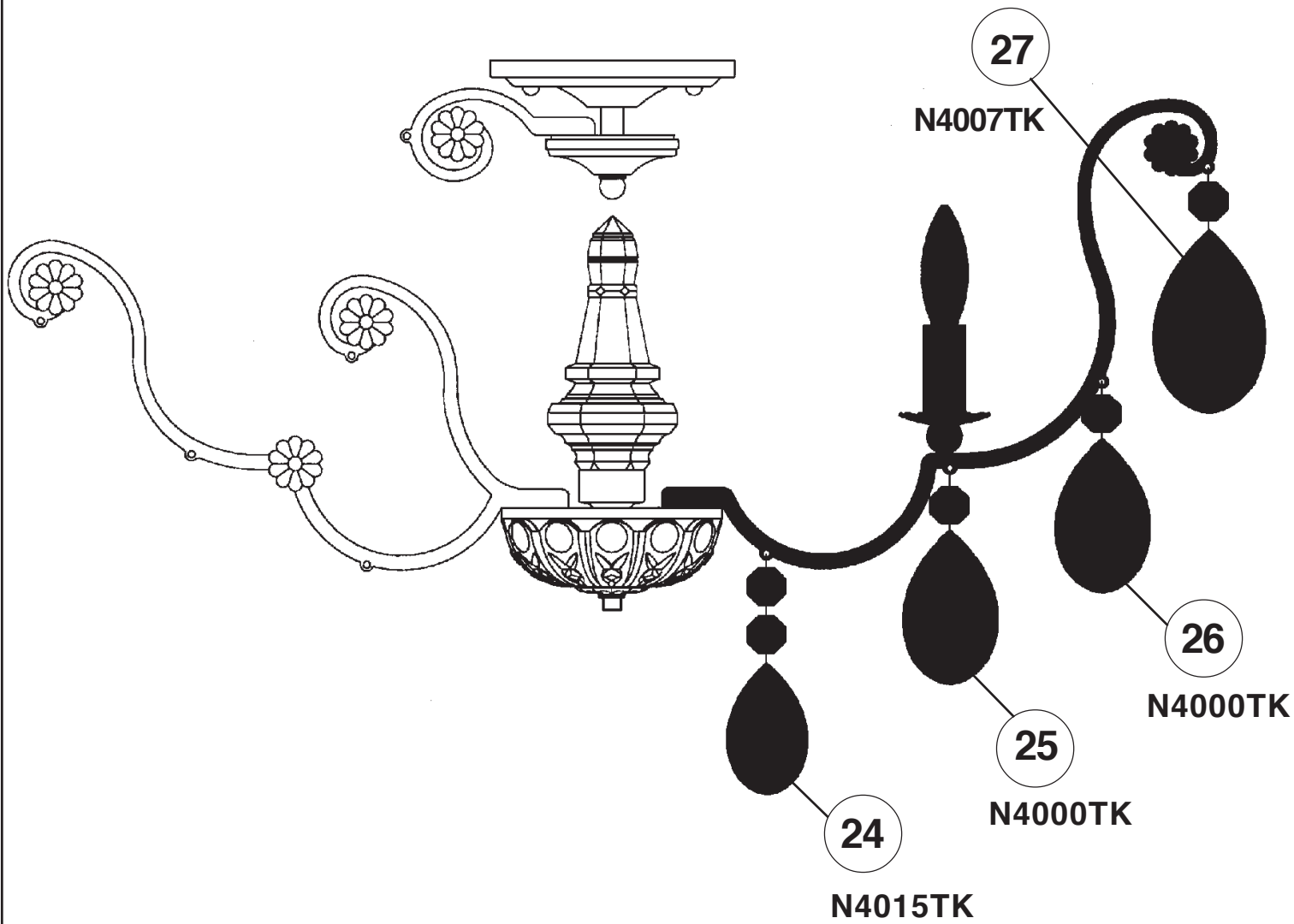

**SET #1**

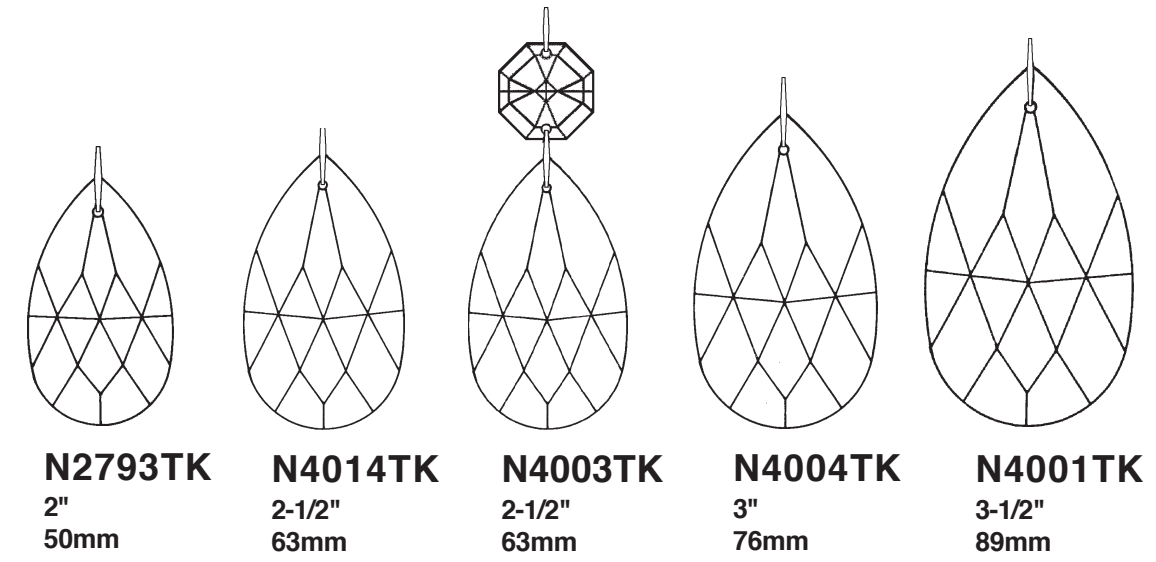

**SET #2**

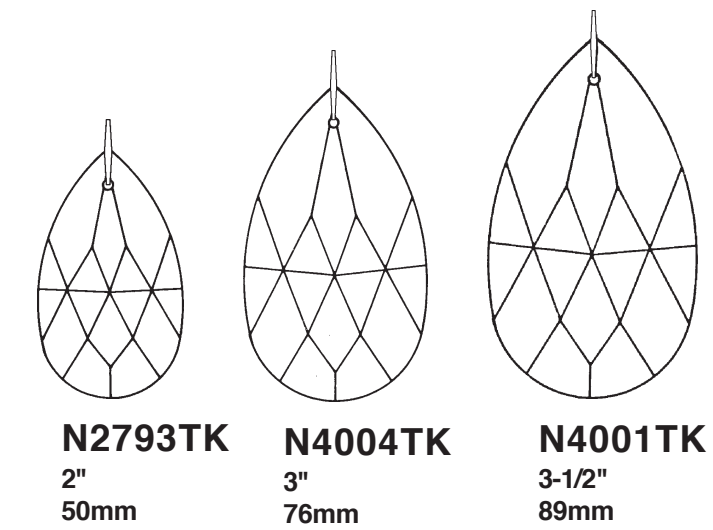

**SET #3**

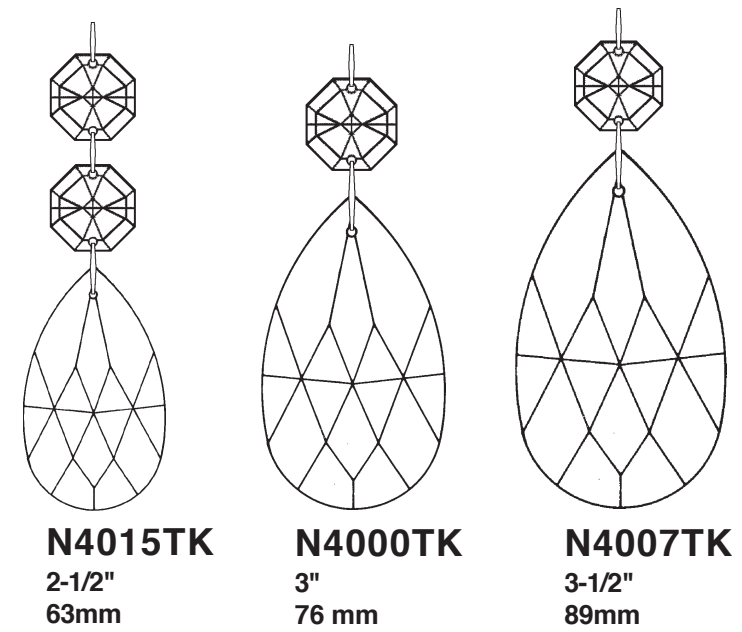

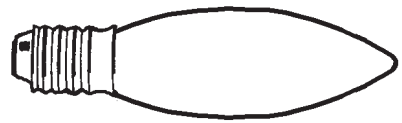

**9** 8 - B10  
60 Watts Max  
25 Watts Recommend

**Crystal Set #2 in Black**

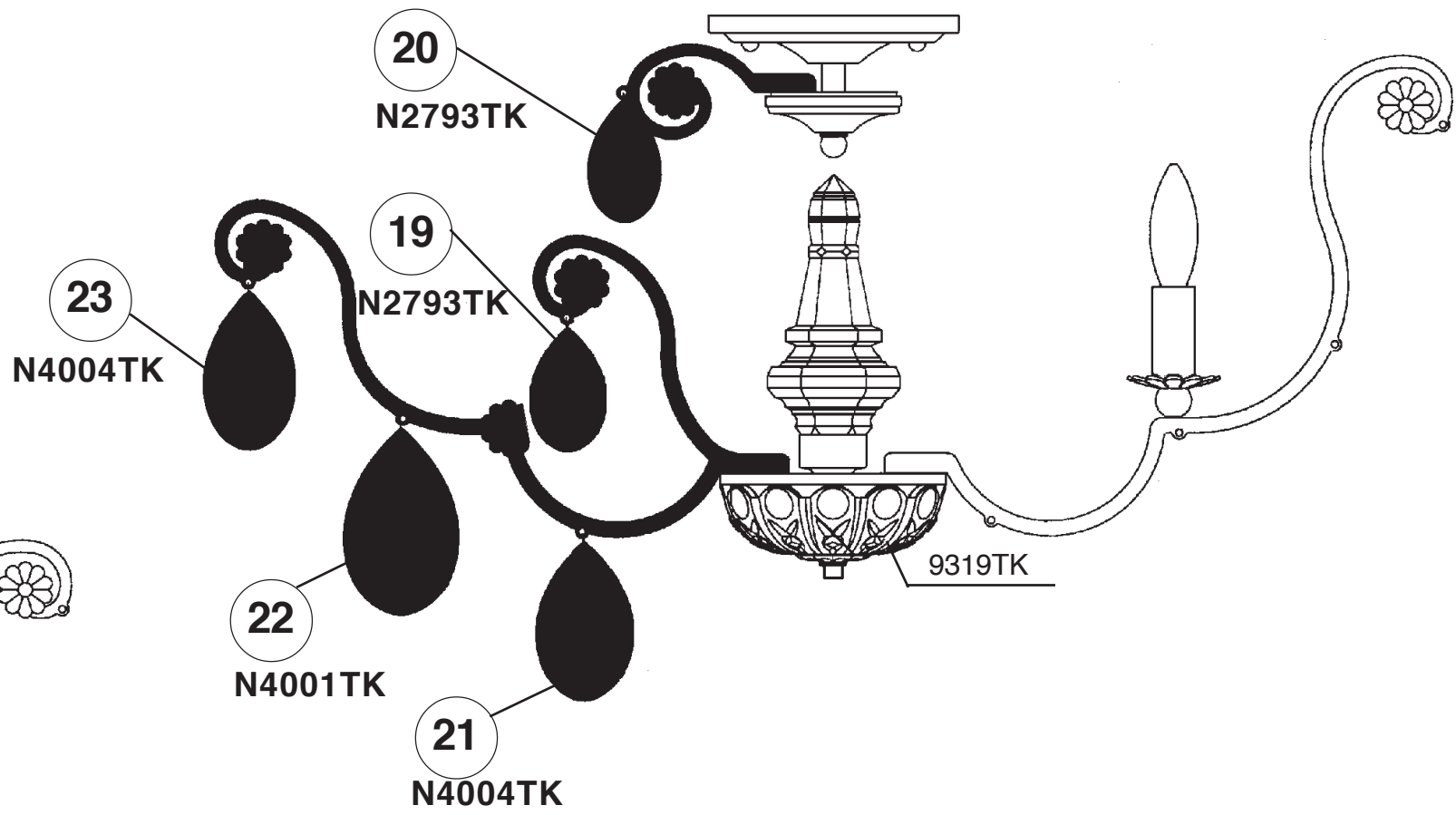

**Crystal Set #1 in Black**

