

MOE'S

home collection

ASSEMBLY INSTRUCTIONS.

TIBURON MEDIA CABINET BLUSH

SR-1022-29

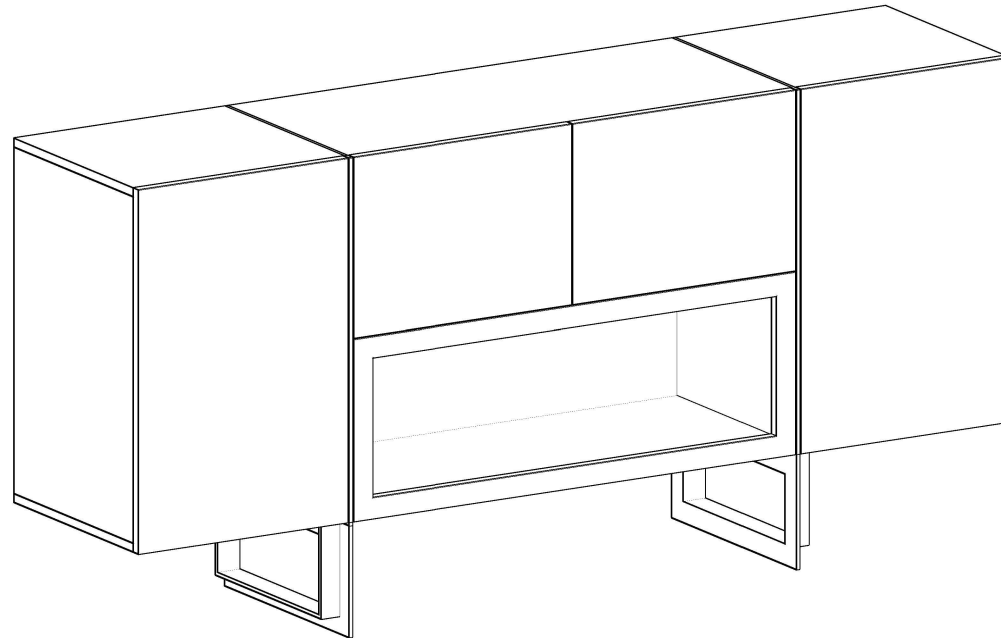



THANK YOU FOR YOUR PURCHASE!

PARTS AND HARDWARE.

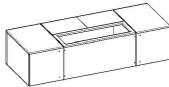
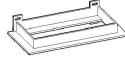
PARTS LIST

No.	DESCRIPTION	IMAGE	QTY
A	BASE		1
B	LEG		2

HARDWARE LIST

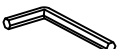
No.	DESCRIPTION	IMAGE	QTY
C	ALLEN BOLT M20-8		08
D	FLAT WASHER M25X8		08
E	ALLEN KEY M5X1		1

NOTES.

Thank you for purchasing this quality product! Be sure to check all packing material carefully for small part that may have come loose inside the carton during shipping.

CAUTION: The item is heavy, assembly should be performed by two people.

STEP 1.

Align Tabs of Metal Leg (B) on to Slots of the Frame which is attached with the Bottom of the Media Cabinet (A) as shown below in diagram, Insert Allen Bolt (C), and tighten with Allen Key (E).

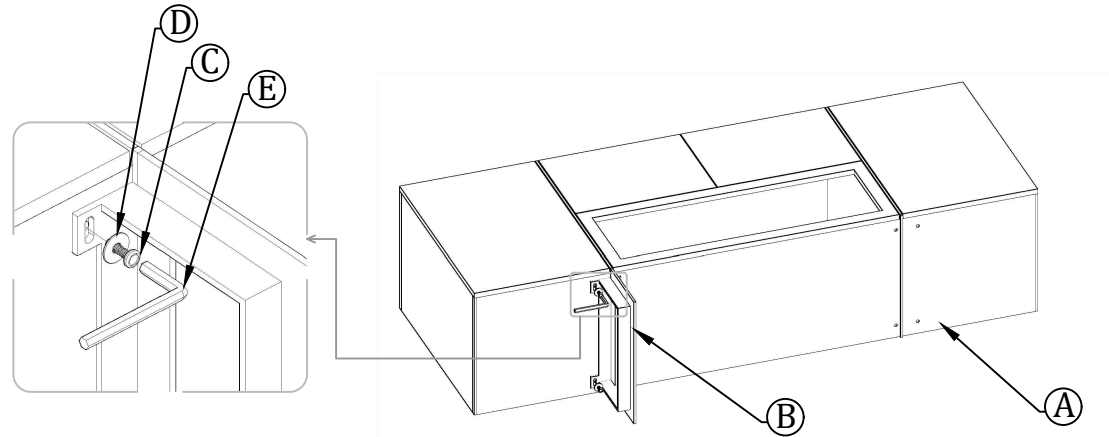

STEP 2.

Align Tabs of Second Metal Leg (B) on to Slots of the Frame which is attached with the Bottom of the Media Cabinet (A) as shown below in diagram, Insert Allen Bolt (C), and tighten with Allen Key (E).

