

# SL2943

## ASSEMBLY & INSTALLATION GUIDE

**WE RECOMMEND INSTALLATION OF THIS LIGHTING FIXTURE BE DONE BY A LICENSED ELECTRICIAN.**

**WARNING \*\*\* SWITCH OFF THE MAIN ELECTRICAL SUPPLY FROM THE MAIN FUSE BOX/CIRCUIT BREAKER BEFORE INSTALLATION.**

**INSPECT ITEM CAREFULLY BEFORE ATTEMPTING TO INSTALL. IF THERE IS ANY DAMAGE OR OBVIOUS DEFECT, DO NOT INSTALL.**

**ITEM MAY NOT BE RETURNED ONCE IT HAS BEEN INSTALLED.**

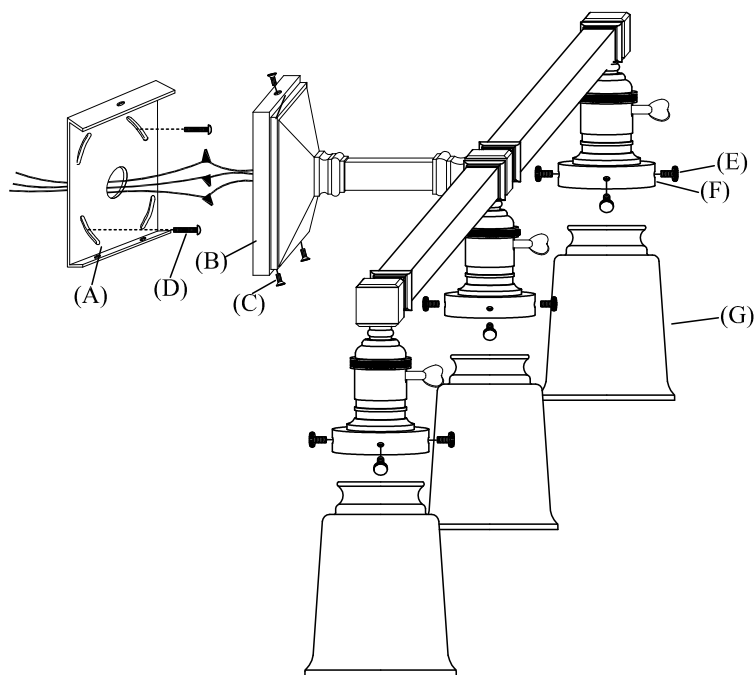

1. Remove back plate (A) from the base of lighting fixture (B) by unscrewing base screws (C) in counterclockwise direction.
2. Affix back plate (A) to wall outlet box with back plate screws (D) provided.
3. Attach ground (green) fixture wire to ground wire from wall outlet box (usually green or copper in color), and fasten together with a plastic wire connector. Tightly wrap the wire connector with electrical tape so the end of the connector is sealed.

IT IS IMPERATIVE THAT THE OUTLET BOX IN YOUR HOME BE PROPERLY GROUNDED.

4. Connect the neutral (white) fixture wire to the neutral (usually white) wire from wall outlet box. Fasten both wires together with a plastic wire connector and tightly wrap the wire connector with electrical tape.
5. Repeat the procedure with the hot (black) wires. Always make sure that no wire strands are left outside the connectors.

DO NOT REVERSE THE HOT AND NEUTRAL CONNECTIONS OR SAFETY WILL BE COMPROMISED.

6. Attach fixture base (B) to back plate (A) and tighten with base screws (C).
7. Remove shade thumbscrews (E) found attached to shade cup (F).
8. Insert glass shade (G) into shade cup (F) and position properly. While holding shade, replace thumbscrews (E) to secure in place. Do not over tighten. Over tightening can cause glass to break.
9. Insert light bulb into socket.