



CAL LIGHTING

3625 E. Philadelphia St. Ontario CA. 91761 • Tel: 909.947.5200 • Fax:
909.947.5673 • www.calighting.com • service@calighting.com • Specifications
subject to change without notice

Type: _____
Project: _____
Catalog No.: _____
Lamp/Wattage: _____

Drawing:

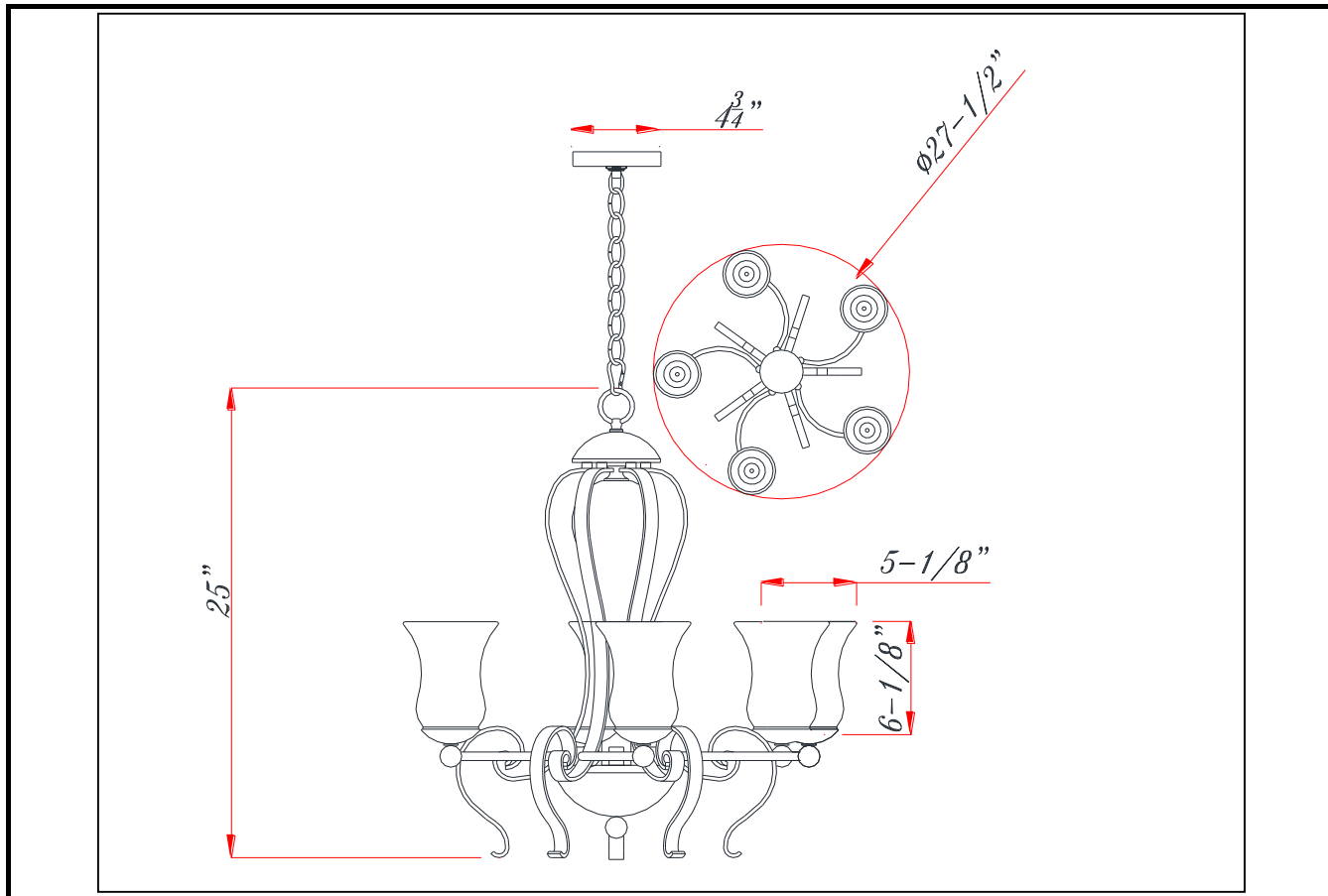

Model No: FX-3548/5
Description: Hand-Forged Iron Classic 5-Light Chandelier with Glass Shades
Material: Metal/Glass
Finish : Eternity
Height: 25"
Width: 27 1/2"
Wattage : 60W x 5
Socket : Medium Base (E26)
Bulb: Incandescent
Chain Length: 6'
Wire Length: 10'
Wire Color: Black
Shade No:
Material: Glass
Shade size: Dia 5 1/8"x 6 1/8"

Certificate : 